

Catálogo - Catalogue

2025

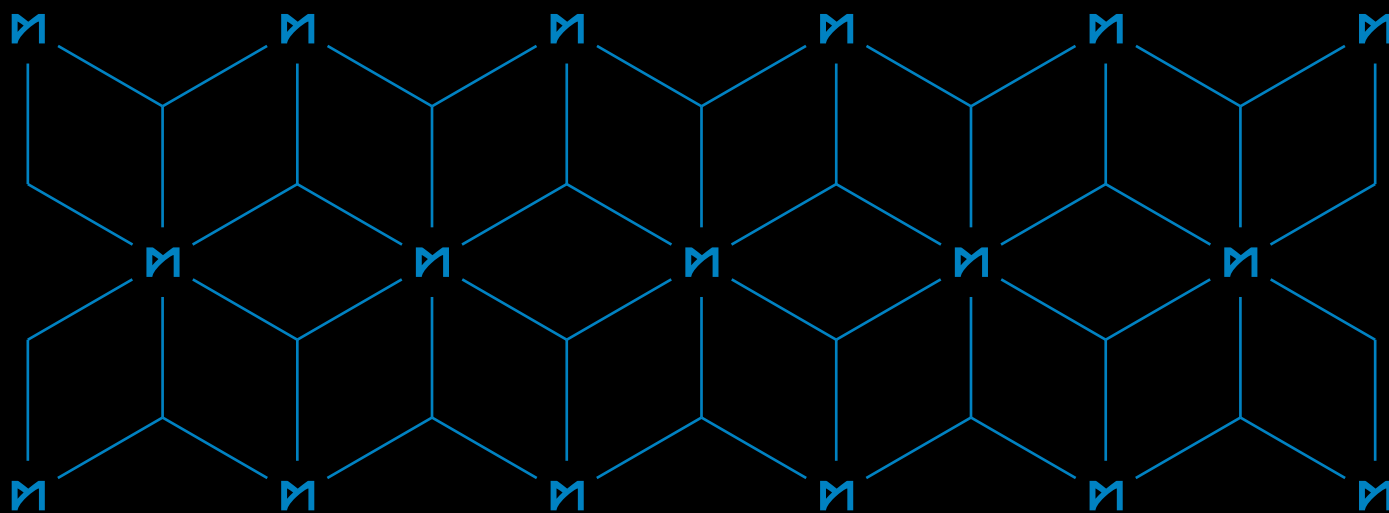

MAIER

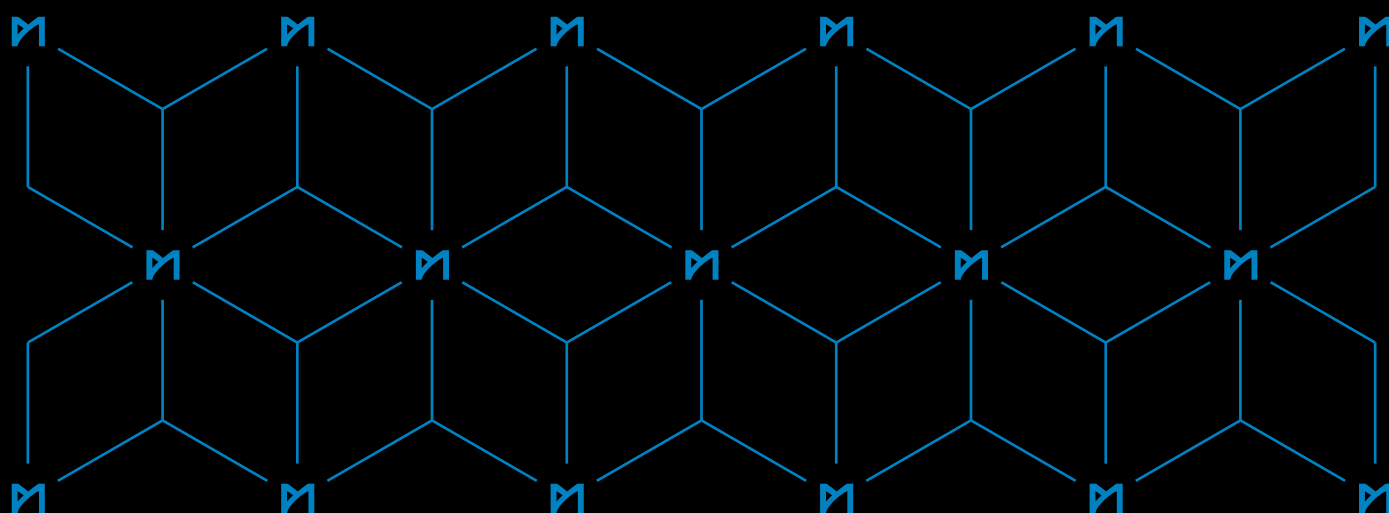

PREMIUM BATHROOM DESIGNS

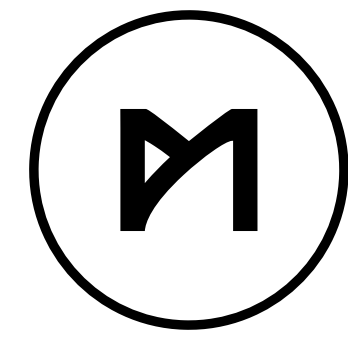
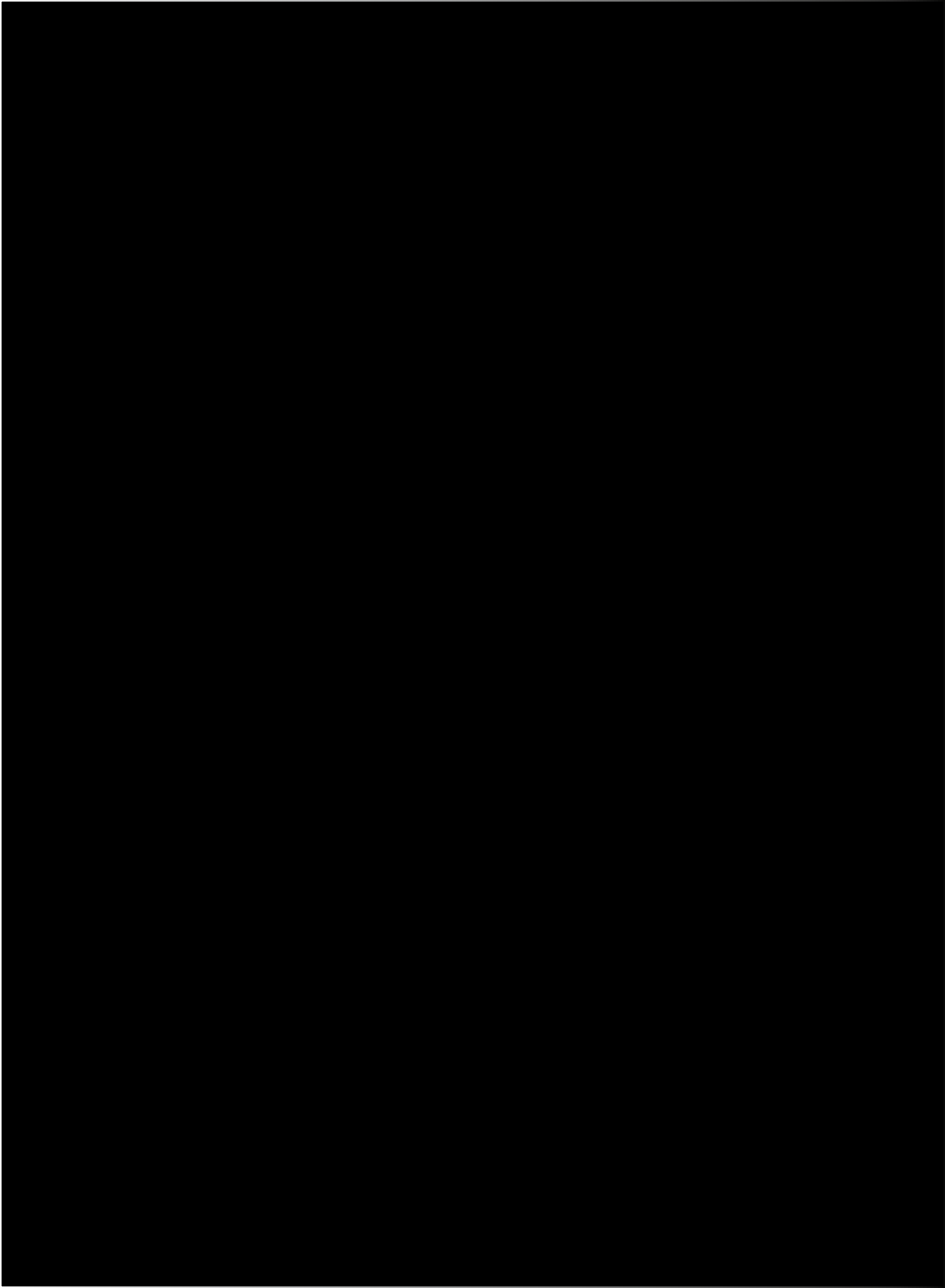

MAIER

Desde 1986

Maier fue fundada en 1986 y está dedicada a la fabricación de grifería sanitaria, cocina y accesorios de baño de calidad. Somos una empresa familiar ubicada en Barcelona, España. En **Maier** estamos comprometidos con el diseño y la fiabilidad, una fórmula impulsada por nuestra pasión, por la excelencia y garantizada por tres generaciones de experiencia. Las colecciones exclusivas diseñadas por **Maier** decoran baños y cocinas en destacados hoteles y residencias en más de 60 países.

Since 1986

Maier was established in 1986 and remains dedicated to manufacture fine bathroom and kitchen faucets and accessories. We are a family-run company operating from Barcelona, Spain. At Maier, we are committed to design and reliability a formula driven by our passion for excellence and guaranteed by three generations of experience. Exclusive collections designed by Maier decorate bathrooms and kitchens in notorious hotels and residences in more than 60 countries.



MAIER

Nuestros valores

Pasión Como empresa familiar, nos gusta nuestro trabajo y creemos en lo que hacemos.

Espíritu de equipo Trabajamos duro con nuestros socios hacia un objetivo común.

Innovación Nos esforzamos constantemente para adaptarnos a las nuevas tendencias.

Integridad Nuestra conducta asegura que Maier es una empresa digna de confianza.

Ecología Contribuimos a conservar el medio ambiente diseñando grifos que ahorran agua.

Flexibilidad Nos adaptamos a las necesidades del mercado local de nuestros clientes.

Our values

Passion As a family-run business, we love our work and believe in what we do.

Team Spirit We work hard with our partners towards a common goal.

Innovation We constantly strive to adapt to new trends.

Integrity Our conduct ensures Maier is a company worthy of trust.

Ecology We contribute to preserve the environment by designing water-saving faucets.

Flexibility We can adapt to our customers' local market needs.

Certificados de Calidad

Maier está comprometido a fabricar con el más alto estándar de calidad y de acuerdo con los requisitos reguladores de los entes de certificación internacionales.

Quality Approvals

Maier is dedicated to produce with the highest standard of quality and according to regulatory requirements of the international certification bodies.

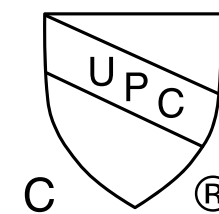

Responsabilidad y compromiso con el medio ambiente

Ahorro de energía

Desde su fundación, **Maier** se ha esforzado por desarrollar e implementar sistemas de ahorro de agua en sus griferías. Ideas creativas y sofisticadas, diseños exclusivos y cuidado del medio ambiente son los pilares principales de nuestra filosofía.

Nuestra responsabilidad ecológica es de 360 grados, no solamente a partir de la creación de nuestros productos y la selección de los materiales más ecológicos, sino también en la aplicación de procesos de reciclado de los residuos.

Responsibility and commitment with the environment

Saving energy

Since its foundation, **Maier** has strived to develop and include water saving technology in its mixers. Creative and sophisticated ideas, exclusive designs and environment care are the main pillars of our philosophy.

Our ecologic responsibility has 360 degrees, starting from the very beginning of the creation of our products, selecting the materials more environmentally friendly, but also applying waste recycling processes.



Proyectos globales

Hoteles boutique, imponentes villas, palacios y sofisticadas residencias de todo el mundo han confiado en los diseños de Maier para sus baños. El sello de nuestra marca aporta valor añadido a los diseñadores de interiores de los cinco continentes. Las colecciones de **Maier** se asocian perfectamente con la arquitectura contemporánea, al diseño de estilo clásico o minimalista, pero siempre con una personalidad que suma sentido y sensibilidad. Maier ha participado en destacados proyectos arquitectónicos en Canadá, Reino Unido, China, Estados Unidos, los Emiratos Árabes, Qatar y en más de sesenta países.

Global Projects

Boutique hotels, sumptuous villas, palaces and sophisticated residences from around the world have relied on Maier's designs for their bathrooms. The seal of our brand brings added value to interior designers from the five continents.

Maier's collections combine perfectly with contemporary architecture, in classical or minimalist designs, but always with a personality that adds meaning and sensitivity. Maier has participated in outstanding architectural projects in Canada, United Kingdom, China, EEUU, the United Arab Emirates, Qatar and in more than sixty countries.



Fredrikson Stallard



Inspirados por la fuerza primaria del cristal, los reconocidos diseñadores Patrik Fredrikson e Ian Stallard han creado para Swarovski las piezas decorativas utilizadas por **Maier** en la lujosa colección Iceberg. Este modelo celebra enfáticamente la naturaleza del material, a la vez que demuestra que la mezcla de herencia e innovación técnica tiene un potencial para el diseño que armoniza perfectamente con las sensibilidades contemporáneas.

Inspired by the raw power of crystal, the renowned designers Patrik Fredrikson and Ian Stallard created for Swarovski the decorative elements used by **Maier** in the fancy Iceberg collection. It emphatically celebrates the nature of the material while it demonstrates that the blend of heritage and technical innovation contains a potential for design that chimes perfectly with contemporary sensibilities.

Iceberg



Paolo Crepax

Es uno de los maestros artesanos más reconocidos de la famosa isla de cristal. Paolo Crepax nació prácticamente en los hornos de Murano y es el creador de una de las colecciones más celebradas de **Maier**. Navegando por la laguna veneciana, emerge Murano, una colección sofisticada con denominación de origen. Seis joyas de cristal con oro o plata convierten cualquier baño en un lugar para recordar.

He is one of the most recognized glass master artisans in the famous glass island. Paolo Crepax is practically born in Murano's glass kilns and successfully created one of the most celebrated **Maier** collections. Navigating the Venetian lagoon, the sophisticated Murano collection emerges. Six different gold or silver crystal jewels turn any bathroom into a place to remember.



Murano



MAIER

MAIER departamento técnico

De la idea al diseño

Nuestra creatividad se transforma en realidad. Los primeros bocetos del diseño son el origen de la metamorfosis del metal en una joya. Trabajamos todos los detalles con la última tecnología para encarnar la belleza distintiva de nuestros grifos y accesorios. Un sueño hecho realidad de la mano de nuestros diseñadores e ingenieros.

Cada nueva creación con decoración y formas únicas está diseñada para reflejar la luz y destinada a convertirse en un icono en los baños de lujo más refinados.



MAIER

MAIER technical department

From the idea to the design

Our creativity is transformed into reality. The first design drafts are the origin of the metamorphosis of the metal into a jewel. We work all details with the latest technology to embody the distinctive beauty of our faucets and accessories. A dream comes true by the hand of our designers and engineers.

Each new creation of unique shapes and decoration is designed to reflect the light and destined to become an icon in the finest luxury bathrooms.



MAIER

Compromiso de calidad

Precisión y calidad. Dos valores que justifican la fiabilidad de los grifos fabricados por Griferías Maier.

La máxima precisión es parte de nuestra cultura. Nuestras áreas de fabricación se someten a un riguroso control de calidad por parte de nuestro personal experimentado. Cada pieza es verificada cuidadosamente como compromiso con nuestros clientes para entregar un grifo radiante de absoluta perfección técnica.

Nuestros productos están concebidos con criterios de respeto al medio ambiente para favorecer el ahorro de agua.



MAIER

Quality commitment

Precision and quality. Two values that justify the reliability of the faucets produced by Griferías Maier.

The maximum accuracy is part of our culture. Our production areas are submitted to a rigorous quality control by our experienced personnel. Each piece is carefully verified as a commitment with our clientele to deliver a radiant faucet with absolute technical perfection.

Our products are designed with criteria of respect for the environment to favor water saving.



MAIER

SWAROVSKI ELEMENTS

Maier, como uno de los principales fabricantes de grifería ornamental del mundo, ofrece una amplia gama de colecciones decoradas con cristales de SWAROVSKI. Somos socios oficiales de esta prestigiosa firma y producimos cada pieza con su certificado de autenticidad que se puede verificar gracias al sello SWAROVSKI.

En los modelos de gama alta de **Maier**, los cristales siempre son incrustados manualmente por artesanos especialistas. Producimos más allá de los más estrictos estándares de calidad y nos encanta hacer realidad los sueños de los diseñadores de interiores. Los grifos joya de **Maier** son un destello de luz en cada hogar con gusto distinguido.

Maier, as one of the leading ornamental faucet manufacturers of the world, offers a wide range of collections decorated with SWAROVSKI crystals. We are official partners of this prestigious brand and produce every piece with its authenticity certificate that can be verified thanks to the SWAROVSKI seal.

In **Maier** high-end series, SWAROVSKI crystals are always manually fixed by specialized artisans. We produce beyond the strictest quality standards and love to make the dreams of interior designers come true. **Maier** diamond faucets are a spark of light in every home with a distinguished taste.

MAIER

Una obra de arte

A work of art

Nuestra grifería ornamental está elegantemente embellecida con cristales Swarovski incrustados manualmente por nuestros especialistas. Un oficio artístico que acaba configurando un mosaico de destellos a nuestras creaciones más exclusivas.

Creemos que el arte y la sensibilidad de nuestros artesanos no pueden ser sustituidas por ninguna máquina. Esta amalgama de calidad y belleza es la clave del éxito de nuestras colecciones Maier, apreciadas en todo el mundo.

Our ornamental mixers are elegantly embellished with Swarovski crystals embedded manually by our specialist craftsmen. An artistic work that ends forming a sparkling mosaic of our most exclusive creations.

We believe that the art and sensibility of our artisans cannot be substituted by any machine. This quality and beauty amalgam is the success key of our Maier collections, appreciated worldwide.



MAIER

Maier Corners

El universo **Maier** puede trasladarse a cualquier punto de venta con nuestra propuesta **Maier Corners**. Ofrecemos una gran variedad de expositores adaptables a cualquier espacio y personalizables con nuestras colecciones prestige o contemporáneas. Te invitamos a reservar un **córnier** de tu showroom a la belleza y creatividad de **Maier**.



MAIER

Maier Corners

The **Maier** universe can be transferred to any point of sale with our **Maier Corners** proposal. We offer a great variety of displays adaptable to any space and customizable with our prestige or contemporary collections. We invite you to reserve a corner of your showroom to the beauty and creativity of **Maier**.



Acabados Finishes

A Grupo / Group

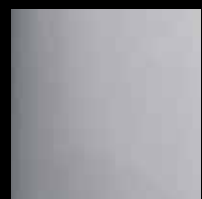

CR
Cromo
Chrome
Chrome
Chrom
Хром

B Grupo / Group



BL
Blanco mate
Matt white
Blanche mate
Weisse matte
Белое

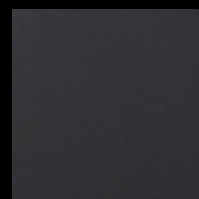

NG
Negro mate
Matt black
Noir mate
Schwarz matte
Черное

C Grupo / Group



CO
Cobre mate
Matt copper
Cuivre mat
Kupfer matt
Матовая медь



BR
Bronce antiguo mate
Old matt bronze
Vieux bronze mat
Altes bronze matt
Матовая состаренная бронза



NI
Níquel cepillado mate
Matt brushed nickel
Matt brossé nickel
Matt gebürstetes Nickel
Брашированный матовый никел

D Grupo / Group



O
Oro
Gold
Or
Gold
Золото



OR
Oro rosa
Rose gold
Or rosé
Rose Gold
Розовое золото



OC
Oro cepillado
Brushed gold
Or brossé
Gebürstetes gold
Брашированное золото

Ejemplo / Example

Colección/ Collection

74
Ikon

Artículo/ Article Type

002
Wash-basin mixer

Acabado/ Finish





CR
Chrome finish

CÓDIGO/ CODE





74 002 CR





	Grupo / Group	B			C			D		
		CR	NG	BL	CO	BR	NI	O	OR	OC
PRESTIGE	Bespoke	●						●		●
	Iceberg	●						●	●	●
	Murano	●						●		●
	Kryos	●						●	●	●
	Starlights	●						●	●	●
	Artik	●						●	●	●
	Rock	●						●	●	●
	Klass	●						●	●	●
	Skip Diamond	●						●	●	●
	Muse Diamond	●						●	●	
Chik Diamond	●						●	●		
CONTEMPORARY	Disk	●						●		●
	Bloom	●						●	●	●
	Ikon	●	●		●			●	●	●
	Skulpture	●						●		●
	Twist	●						●		●
	Mini Star	●	●	●	●	●	●	●	●	●
	Cylinder	●	●	●	●		●	●	●	●
	G1	●	●					●	●	●
	Kuadrat	●	●		●			●	●	●
	Kub	●	●		●			●	●	●
HYDROTHERAPY	Maxima	●	●					●		
	Skip	●	●					●		●
	Muse	●						●	●	
	Chik	●						●	●	
	Memory	●					●	●		
	Kromotherapy	●	●	●	●	●	●	●	●	●
	Rociadores / Showerheads	●	●	●	●	●	●	●	●	●
	Empotrados / Built-In	●	●	●	●	●	●	●	●	●
	Complementos Ducha / Shower Complements	●	●	●	●	●	●	●	●	●
	Columnas Ducha / Shower Columns	●	●	●	●	●	●	●	●	●
Grifos De Pie / Floor-Standings Mixers	●	●	●	●	●	●	●	●	●	
Duchitas Bidé / Shut-Off	●	●	●	●	●	●	●	●	●	
ACCESSORIES	Mini Star	●	●	●	●	●	●	●	●	●
	Ikon	●	●		●			●	●	●
	Muse Diamond	●						●	●	●
	Artik Round	●						●	●	●
	Kuadrat	●	●		●			●	●	●
KITCHEN & COMPLEMENTS	Skip Diamond	●						●	●	●
	Fregaderas / Sink Mixers	●	●				●	●	●	
Complementos / Complements	●	●	●	●	●	●	●	●	●	

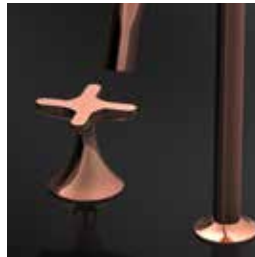

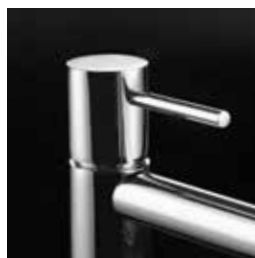

Prestige		Octagon	20		Glam	28		Ethereal	38		Bespoke	46		Clodette	58
-----------------	---	----------------	----	---	-------------	----	---	-----------------	----	--	----------------	----	---	-----------------	----

	Iceberg	70		Murano	78		Kryos	90		Starlights	102		Artik	114
---	----------------	----	---	---------------	----	---	--------------	----	--	-------------------	-----	---	--------------	-----

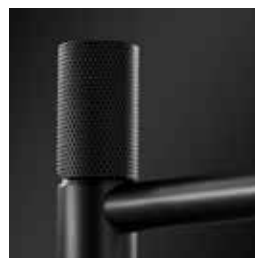



	Rock	122		Klass	130		Skip Diamond	140		Muse Diamond	152		Chik Diamond	153
--	-------------	-----	--	--------------	-----	--	---------------------	-----	---	---------------------	-----	--	---------------------	-----

Contemporary		Concrete	166		Disk	178		Bloom	186		Ikon	194		Skulpture	212
---------------------	---	-----------------	-----	---	-------------	-----	---	--------------	-----	--	-------------	-----	---	------------------	-----



	Twist	224		316L	238		Mini Star	254		Cylinder	274		G1	282
---	--------------	-----	---	-------------	-----	---	------------------	-----	--	-----------------	-----	---	-----------	-----

	Kwadrat	290		Kub	306		Maxima	314		Skip	322		Muse	334
---	----------------	-----	---	------------	-----	---	---------------	-----	---	-------------	-----	---	-------------	-----

	Chik	335		Memory	342	Hydrotherapy		Kromotherapy	350		Hydrotherapy	360
---	-------------	-----	---	---------------	-----	---------------------	---	---------------------	-----	---	---------------------	-----

Accessories		Mini Star	398		Ikon	408		Muse Diamond	414		Artik Round	422
--------------------	--	------------------	-----	--	-------------	-----	--	---------------------	-----	--	--------------------	-----

	Kwadrat	428		Skip Diamond	434	Kitchen			440
---	----------------	-----	---	---------------------	-----	----------------	---	--	-----

Complements			454	Displays			462
--------------------	---	--	-----	-----------------	---	--	-----

85 Octagon



PRESTIGE

Octagon



El viaje a Murano convertido en geometría sublime.
 Octagon reinterpreta el legado de los maestros vidrieros de la isla de Murano, transformando la tradición en arte contemporáneo. Su diseño octogonal, elaborado en cristal de Murano, fusiona con maestría la precisión geométrica y la belleza artesanal. Cada faceta, desde sus bordes definidos hasta los destellos que reflejan la luz, encapsula la elegancia y sofisticación de una pieza única.

The journey to Murano turned into sublime geometry.
 Octagon reinterprets the legacy of the master glassmakers of the Italian Murano island, transforming tradition into contemporary art. Its octagonal design, crafted in Murano glass, masterfully merges geometric precision and artisanal beauty. Each facet, from its defined edges to the sparkles that reflect the light, encapsulates the elegance and sophistication of a unique piece.



PL Plata Silver
OR Oro Gold
FU Fumé Fume
GR Gris Grey



CR Cromo Chrome Chrome Chrom Хром
NG Negro mate Matt black Noir mate Schwarz matte Черное
O Oro Gold Gold Золото
OC Oro cepillado Brushed gold Or brossé Gebürstetes gold Брашированное золото
GCP Grafito Cepillado PVD Brushed Gun Metal PVD Graphite Brossé PVD Gebürstetes Gun Metal PVD матовый металл PVD



85 005 J GCP GR
 Juego lavabo caño central
 Wash basin in 3 holes mixer

MAIER

85 Octagon

PRESTIGE





85 005 J NG PL
Juego lavabo caño central
Wash basin in 3 holes mixer

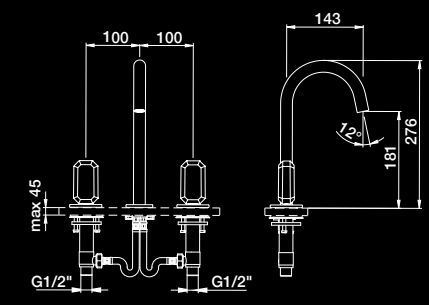

85 005J ● ● ● ● ● ●
Juego lavabo caño central
Wash basin in 3 holes mixer
Mélangeur 3 trous pour lavabo
Waschtischmischer dreilochbatterie
Смеситель для раковины на 3 отверстия

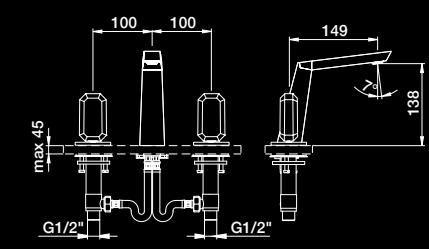
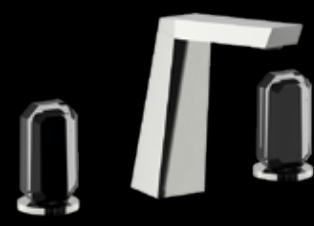

85 005K ● ● ● ● ● ●
Juego lavabo caño central
Wash basin in 3 holes mixer
Mélangeur 3 trous pour lavabo
Waschtischmischer dreilochbatterie
Смеситель для раковины на 3 отверстия

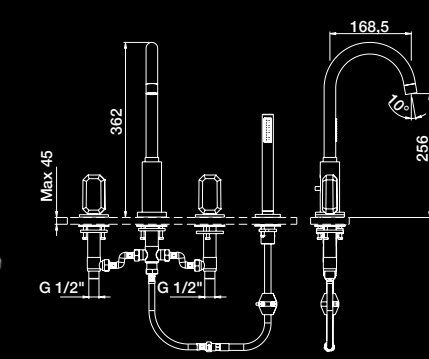

85 075J ● ● ● ● ● ●
Juego lavabo caño central válv. desag. click-clack
Wash basin in 3 holes mixer with click-clack waste
Mélangeur 3 trous pour lavabo avec vidage click-clack
Waschtischmischer dreilochbatterie mit click-clack ablauf
Смеситель для раковины на 3 отверстия с клапаном клик-клак

- **CR**
Cromo
Chrome
- **NG**
Negro mate
Matt black
- **O**
Oro
Gold
- **OC**
Oro cepillado
Brushed gold
- **GCP**
Grafito Cepillado PVD
Brushed Gun Metal PVD

87 Glam

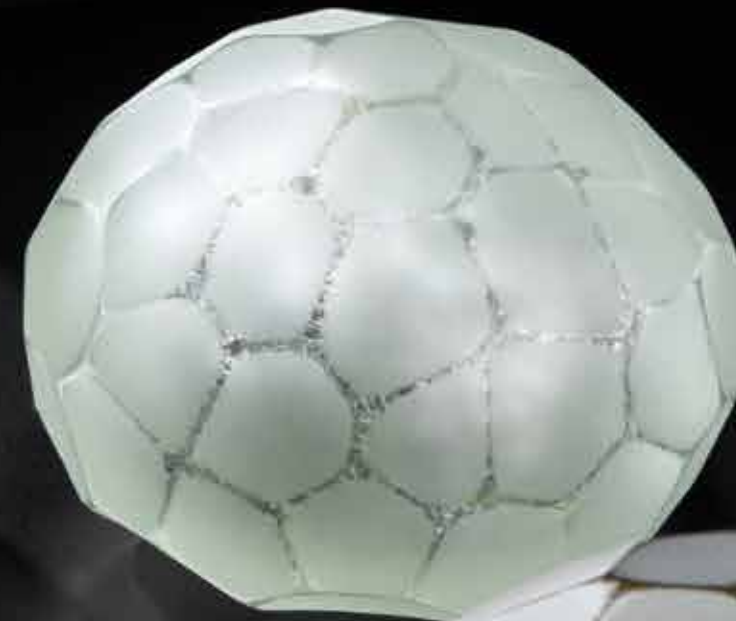

Glam

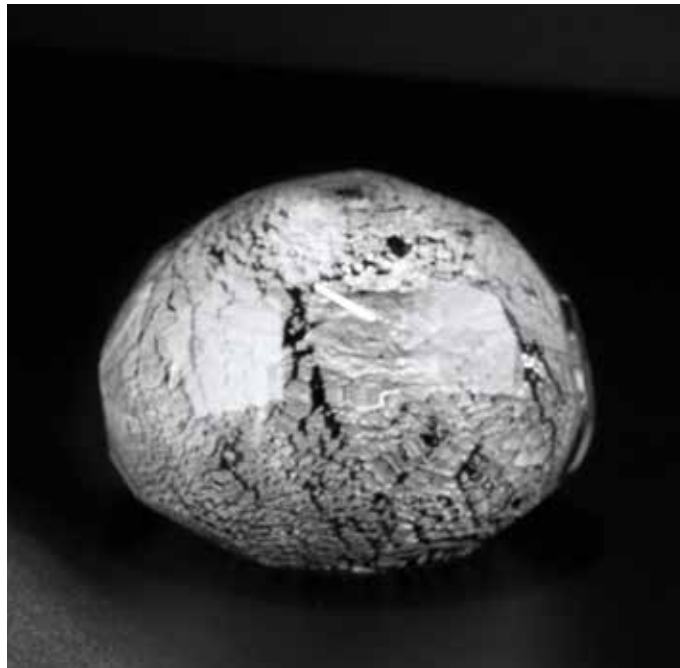

Esplendor en estado puro.

Glam encarna la tradición de los maestros artesanos de la isla de Murano con formas orgánicas y acabados deslumbrantes. En su corazón, el cristal de Murano trabajado con delicadeza envuelve el oro o plata, creando un contraste único entre brillo y textura. Esta pieza exclusiva transforma el baño en un espacio de arte funcional, donde la herencia artesanal se encuentra con el diseño contemporáneo.

Splendor in pure state.

Glam embodies the tradition of the master craftsmen of Murano island with organic shapes and dazzling finishes. At its heart, the delicately crafted Murano glass envelops gold or silver, creating a unique contrast between brilliance and texture. This exclusive piece transforms the bathroom into a functional art space, where artisan heritage meets contemporary design.



PB
Plata Negro Brillo
Black Silver



OB
Oro Negro Brillo
Black Gold



GM
Gris Mate
Matt Grey



FM
Fumé Mate
Matt Fume



PM
Plata Mate
Matt Silver



CR
Cromo
Chrome
Chrome
Chrom
Хром



NG
Negro mate
Matt black
Noir mate
Schwarz matte
Черное



O
Oro
Gold
Or
Gold
Золото



OC
Oro cepillado
Brushed gold
Or brossé
Gebürstetes gold
Брашированное золото



GCP
Grafito Cepillado PVD
Brushed Gun Metal PVD
Graphite Brossé PVD
Gebürstetes Gun Metal PVD
матовый металл PVD



87 305 NG OB
Bimando lavabo empotrado
Concealed 3 holes wash basin mixer



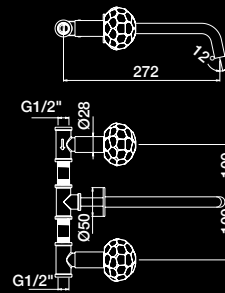
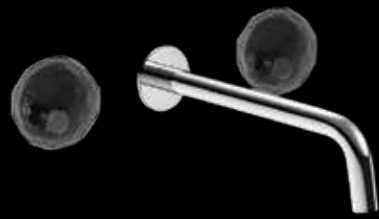

87 305 ●●●●●●
 Bimando lavabo empotrado
 Concealed 3 holes wash basin mixer
 Mélangeur de lavabo 3 trous à encastrer
 Unterputz 3-Loch Waschtischmischer
 Встроенный смеситель для раковины на 3 отверстия

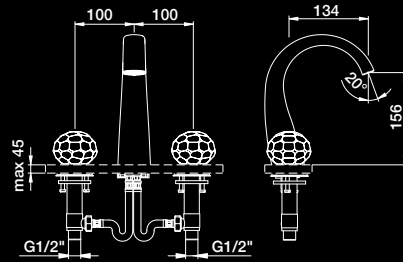

87 307 ●●●●●●
 Bimando lavabo empotrado válvula desagüe click-clack
 Concealed 3 holes wash basin mixer with click-clack waste
 Mélangeur de lavabo 3 trous à encastrer avec vidage click-clack
 Unterputz 3-Loch Waschtischmischer mit Click-Clack Ablaufgarnitur
 Встроенный смеситель для раковины на 3 отверстия со сливом клик-клак

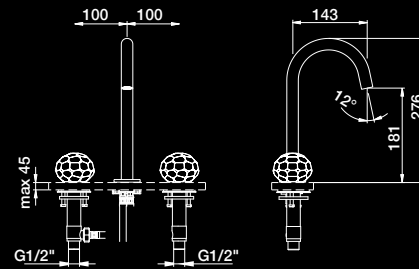

87 005P ●●●●●●
 Juego lavabo caño central
 Wash basin in 3 holes mixer
 Mélangeur 3 trous pour lavabo
 Waschtischmischer dreilochbatterie
 Смеситель для раковины на 3 отверстия

87 075P ●●●●●●
 Juego lavabo caño central válv. desag. click-clack
 Wash basin in 3 holes mixer with click-clack waste
 Mélangeur 3 trous pour lavabo avec vidage click-clack
 Waschtischmischer dreilochbatterie mit click-clack ablauf
 Смеситель для раковины на 3 отверстия с клапаном клик-клак

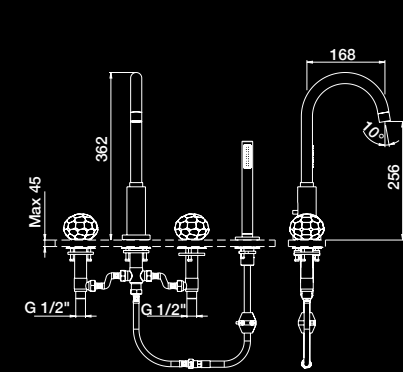

87 005J ●●●●●●
 Juego lavabo caño central
 Wash basin in 3 holes mixer
 Mélangeur 3 trous pour lavabo
 Waschtischmischer dreilochbatterie
 Смеситель для раковины на 3 отверстия

87 075J ●●●●●●
 Juego lavabo caño central válv. desag. click-clack
 Wash basin in 3 holes mixer with click-clack waste
 Mélangeur 3 trous pour lavabo avec vidage click-clack
 Waschtischmischer dreilochbatterie mit click-clack ablauf
 Смеситель для раковины на 3 отверстия с клапаном клик-клак

- **CR**
Cromo
Chrome
- **NG**
Negro mate
Matt black
- **O**
Oro
Gold
- **OC**
Oro cepillado
Brushed gold
- **GCP**
Grafito Cepillado PVD
Brushed Gun Metal PVD



87 005 P CR PB
 Juego lavabo caño central
 Wash basin in 3 holes mixer

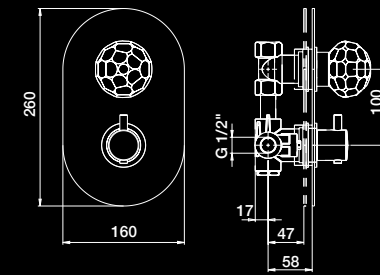

87 601 / 87 602 / 87 603

Termostático baño ducha empotrar con inversor 1/ 2/ 3 vías
 Thermostatic concealed bath shower with diverter 1/ 2/ 3 ways
 Mitigeur thermostatique bain/douche à encastrer avec inverseur 1/ 2/ 3 voies
 Thermostat für brause/wannenbatterie mit umstellung 1/ 2/ 3 abgängen
 Термостатический смеситель встроенный душ и ванна на 1/ 2/ 3 выхода

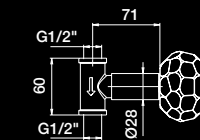
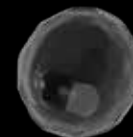

87 016

Llave de paso empotrar 1/2"
 Built-in key step 1/2"
 Robinet d'arrêt de 1/2"
 Unterputz-ventil 1/2"
 Кран встроенный 1/2"

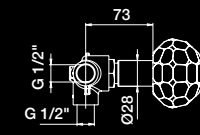
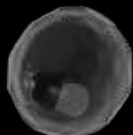

87 320 / 87 330 / 87 340 / 87 350

Distribuidor empotrar 2/3/4/5 salidas
 Built-in diverter 2/3/4/5 ways
 Inverseur 2/3/4/5 voies à encastrer
 2/3/4/5-wege-umsteller
 Встроенный дивертер на 2/3/4 /5 выхода

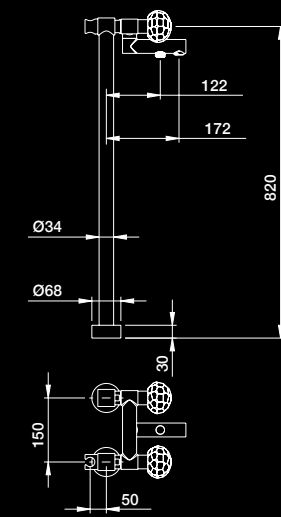

87 512

Grupo baño ducha con columna suelo de 820 mm
 Bath shower group with floorstanding column of 820 mm
 Mélangeur bain-douche sur colonne de 820 mm
 Wannen batterie mit 820 mm hohen boden anschluss, handbrause und flexibel schlauch
 Смеситель ванна / душ с напольными колоннами 820 mm

CR
Cromo
Chrome

NG
Negro mate
Matt black

O
Oro
Gold

OC
Oro cepillado
Brushed gold

GCP
Grafito Cepillado PVD
Brushed Gun Metal PVD

84 Ethereal



Ethereal



Un fragmento de luz suspendida.

Ethereal, captura la magia de la isla Murano en una forma fluida y celestial. Sus pomos, elaborados artesanalmente en cristal azul aguamarina o fumé, evocan la transparencia del agua y la profundidad del aire. Cada pieza, moldeada con la delicadeza de los maestros vidrieros, transforma el baño en un espacio de calma y contemplación, donde el diseño se convierte en poesía visual.

A fragment of suspended light.

Ethereal captures the magic of the Murano Island in a fluid and heavenly form. Its handles, artisanally crafted in aquamarine or fumé glass, evoke the transparency of water and the depth of air. Each piece, shaped with the delicacy of master glassmakers, transforms the bathroom into a space of calm and contemplation, where design becomes visual poetry.



AQ
Azul Aquamarine
Aquamarine Blue



FU
Fumé
Fume

CR
Cromo
Chrome
Chrome
Хром

O
Oro
Gold
Or
Gold
Золото

OC
Oro cepillado
Brushed gold
Or brossé
Gebürstetes gold
Брашированное золото



84 005 J CR AQ
Juego lavabo caño central
Wash basin in 3 holes mixer



84 005 P OC FU
Juego lavabo caño central
Wash basin in 3 holes mixer

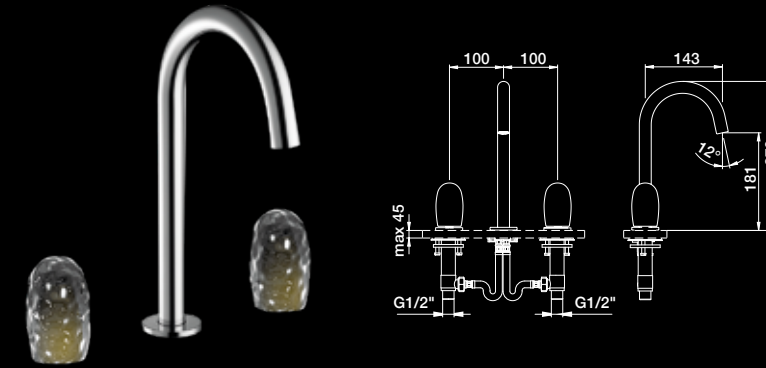

84 005J ●●●●

Juego lavabo caño central
Wash basin in 3 holes mixer
Mélangeur 3 trous pour lavabo
Waschtischmischer dreilochbatterie
Смеситель для раковины на 3 отверстия

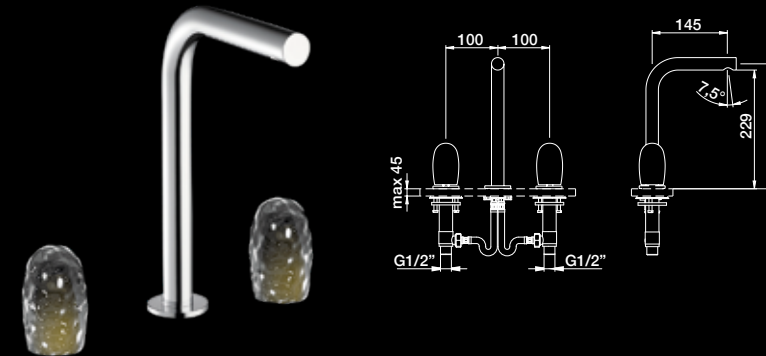

84 005L ●●●●

Juego lavabo caño central
Wash basin in 3 holes mixer
Mélangeur 3 trous pour lavabo
Waschtischmischer dreilochbatterie
Смеситель для раковины на 3 отверстия

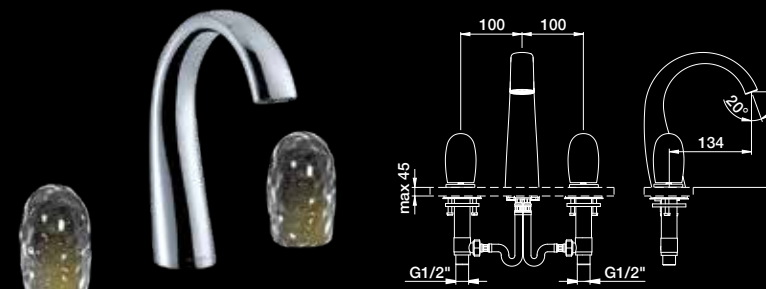

84 005P ●●●●

Juego lavabo caño central
Wash basin in 3 holes mixer
Mélangeur 3 trous pour lavabo
Waschtischmischer dreilochbatterie
Смеситель для раковины на 3 отверстия



84 075J ●●●●

Juego lavabo caño central válv. desag. click-clack
Wash basin in 3 holes mixer with click-clack waste
Mélangeur 3 trous pour lavabo avec vidage click-clack
Waschtischmischer dreilochbatterie mit click-clack ablauf
Смеситель для раковины на 3 отверстия с клапаном клик-клак



84 305 ●●●●

Bimando lavabo empotrado
Concealed 3 holes wash basin mixer
Mélangeur de lavabo 3 trous à encastrer
Unterputz 3-Loch Waschtischmischer
Встроенный смеситель для раковины на 3 отверстия

84 307 ●●●●

Bimando lavabo empotrado válvula desagüe click-clack
Concealed 3 holes wash basin mixer with click-clack waste
Mélangeur de lavabo 3 trous à encastrer avec vidage click-clack
Unterputz 3-Loch Waschtischmischer mit Click-Clack Ablaufgarnitur
Встроенный смеситель для раковины на 3 отверстия со сливом клик-клак

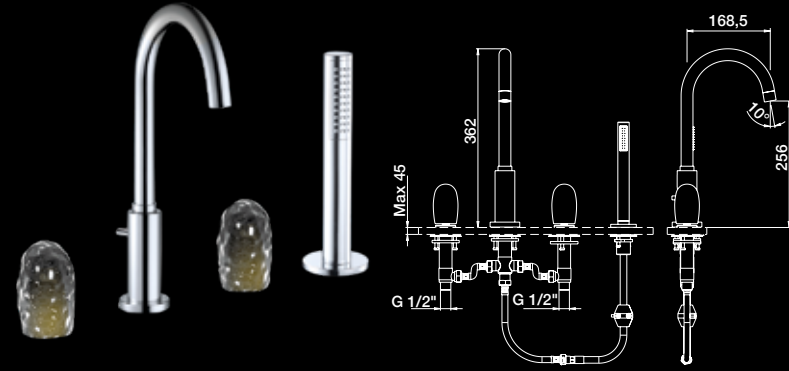

84 714J ●●●●

Grupo baño ducha 4 agujeros de repisa con ducha
 Bath shower 4 holes mixer with handshower
 Ensemble bain-douche 4 trous sur gorge avec ensemble de douche
 Wannenrand bad und duschmischer
 Смеситель на борт ванны для 4 отверстий с ручным душем



84 601 / 84 602 / 84 603 ●●●●

Termostático baño ducha empotrar con inversor 1/ 2/ 3 vías
 Thermostatic concealed bath shower with diverter 1/ 2/ 3 ways
 Mitigeur thermostatique bain/douche à encastrer avec inverseur 1/ 2/ 3 vois
 Thermostat für brause/wannenbatterie mit umstellung 1/ 2/ 3 abgängen
 Термостатический смеситель встроенный душ и ванна на 1/ 2/ 3 выхода

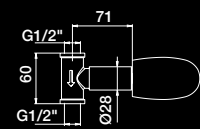

84 016 ●●●●

Llave de paso empotrar 1/2"
 Built-in key step 1/2"
 Robinet d'arrêt de 1/2"
 Unterputz-ventil 1/2"
 Кран встроенный 1/2"

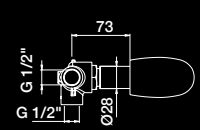

84 320 / 84 330 / 84 340 / 84 350 ●●●●

Distribuidor empotrar 2/3/4/5 salidas
 Built-in diverter 2/3/4/5 ways
 Inverseur 2/3/4/5 voies à encastrer
 2/3/4/5-wege-umsteller
 Встроенный дивертер на 2/3/4 /5 выхода

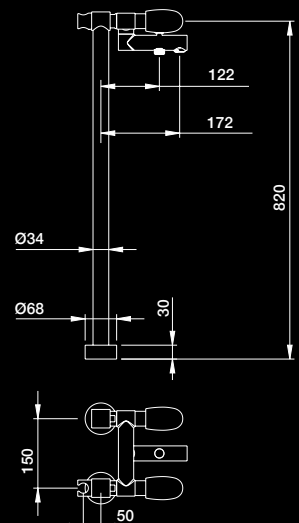

84 512 ●●●●

Grupo baño ducha con columna suelo de 820 mm
 Bath shower group with floorstanding column of 820 mm
 Mélangeur bain-douche sur colonne de 820 mm
 Wannen batterie mit 820 mm hohen boden anschluss, handbrause und fiffexiblen schlauch
 Смеситель ванна / душ с напольными колоннами 820 mm

- **CR**
Cromo
Chrome
- **O**
Oro
Gold
- **OC**
Oro cepillado
Brushed gold



82 Bespoke



Bespoke



La fuerza del universo. Fragmentos de luz y de materia primigenios condensados en un diseño que dialoga con el futuro. La sinuosidad cromática y el contraste de texturas abren una puerta hacia el infinito. Seis piedras semipreciosas, seis caminos, para convertir tu baño en un lugar irrepetible.

The force of the universe. Fragments of primitive light and matter condensed in a design that dialogues with the future. The chromatic sinuosity and the contrast of textures open a door to infinity. Six semi-precious stones, six paths, to turn your bathroom into a unique place.

Pomos / Handles



- L**
Liso
Plain
- P**
Puntos
Dots
- R**
Rayas
Stripes
- C**
Curvo
Curved

Piedras semipreciosas / Semiprecious stones



- LP**
Lapislázuli
Lapis lazuli
- ML**
Malaquita
Malachite
- AM**
Amatista
Amethyst
- OT**
Ojo de tigre
Tiger Eye
- PB**
Madre perla blanco
Mother of Pearl White
- PG**
Madre perla gris
Mother of Pearl Grey

- CR**
Cromo
Chrome
Chrome
Chrom
Хром
- O**
Oro
Gold
Or
Gold
Золото
- OC**
Oro cepillado
Brushed gold
Or brossé
Gebürstetes gold
Брашированное золото

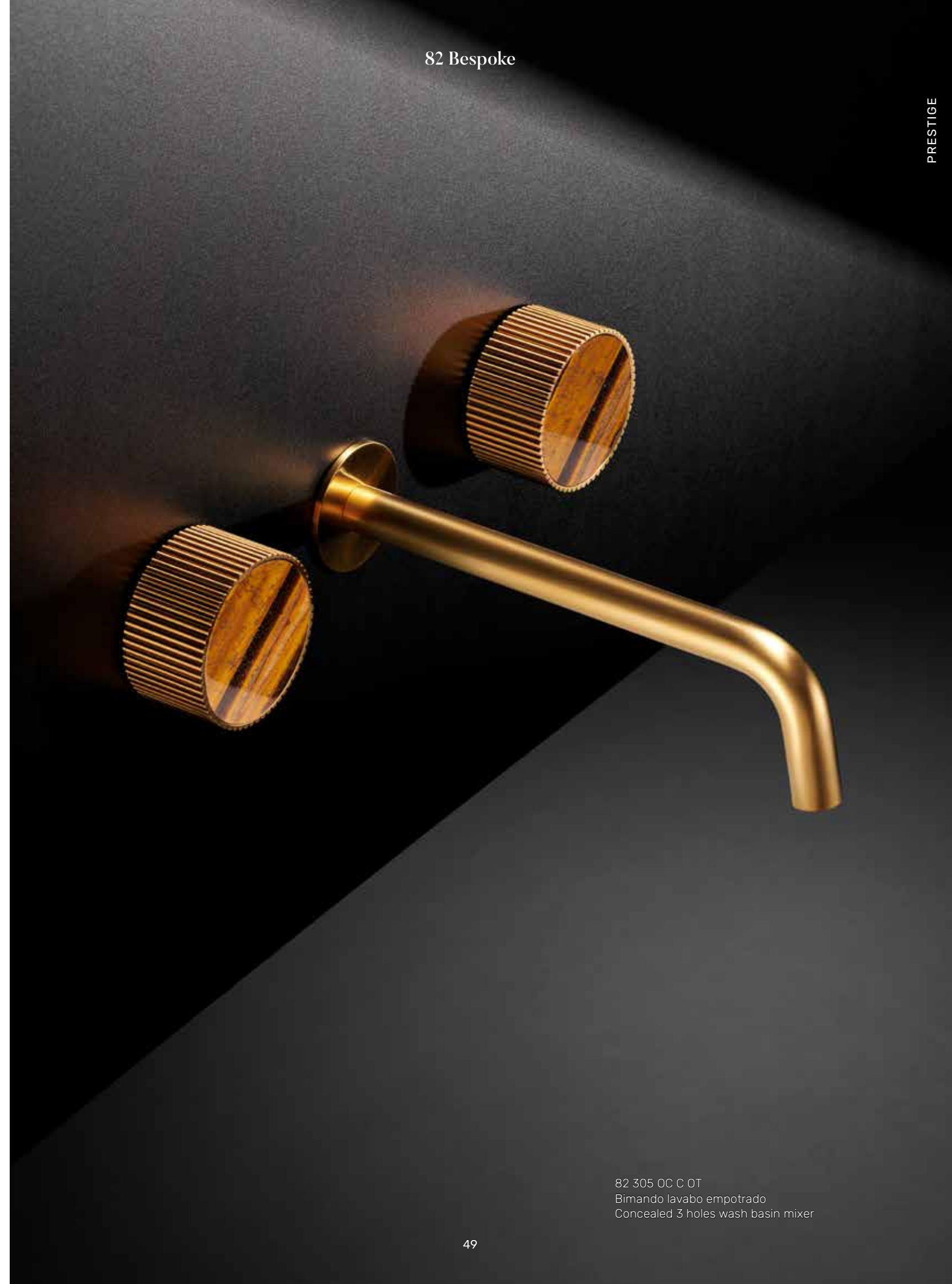



82 005J O P LP
Juego lavabo caño central
Wash basin in 3 holes mixer



82 016 O R LP / C ML / C AM / L OT / P PB / P PG
 Llave de paso empotrar 1/2"
 Built-in key step 1/2"



82 005L CR R PG
 Juego lavabo caño central
 Wash basin in 3 holes mixer



82 005J O R ML
Juego lavabo caño central
Wash basin in 3 holes mixer

82 Bespoke

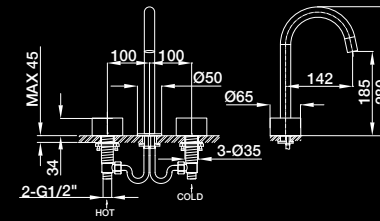

82 005J ●●●●

Juego lavabo caño central
Wash basin in 3 holes mixer
Mélangeur 3 trous pour lavabo
Waschtischmischer dreilochbatterie
Смеситель для раковины на 3 отверстия

82 075J ●●●●

Juego lavabo caño central válv. desag. click-clack
Wash basin in 3 holes mixer with click-clack waste
Mélangeur 3 trous pour lavabo avec vidage click-clack
Waschtischmischer dreilochbatterie mit click-clack ablauf
Смеситель для раковины на 3 отверстия с клапаном клик-клак

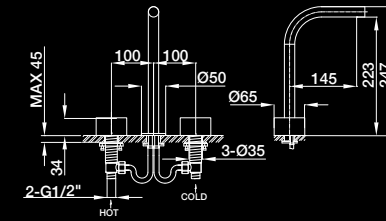

82 005L ●●●●

Juego lavabo caño central
Wash basin in 3 holes mixer
Mélangeur 3 trous pour lavabo
Waschtischmischer dreilochbatterie
Смеситель для раковины на 3 отверстия

82 075L ●●●●

Juego lavabo caño central válv. desag. click-clack
Wash basin in 3 holes mixer with click-clack waste
Mélangeur 3 trous pour lavabo avec vidage click-clack
Waschtischmischer dreilochbatterie mit click-clack ablauf
Смеситель для раковины на 3 отверстия с клапаном клик-клак

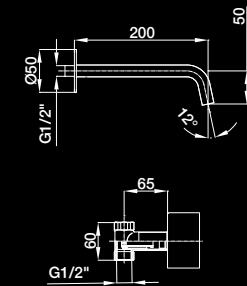
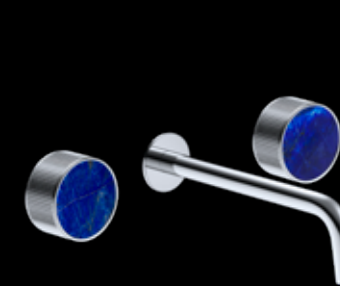

82 305 ●●●●

Bimando lavabo empotrado
Concealed 3 holes wash basin mixer
Mélangeur de lavabo 3 trous à encastrer
Unterputz 3-Loch Waschtischmischer
Встроенный смеситель для раковины на 3 отверстия

82 307 ●●●●

Bimando lavabo empotrado válvula desagüe click-clack
Concealed 3 holes wash basin mixer with click-clack waste
Mélangeur de lavabo 3 trous à encastrer avec vidage click-clack
Unterputz 3-Loch Waschtischmischer mit Click-Clack Ablaufgarnitur
Встроенный смеситель для раковины на 3 отверстия со сливом клик-клак

- CR
Cromo
Chrome
- O
Oro
Gold
- OC
Oro cepillado
Brushed gold

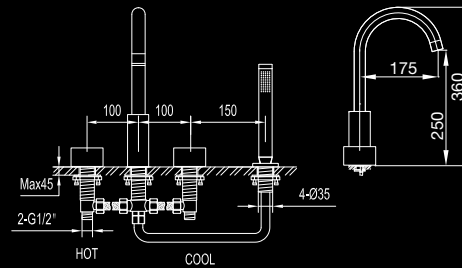

82 714J ●●●●

Grupo baño ducha 4 agujeros de repisa con ducha
 Bath shower 4 holes mixer with handshower
 Ensemble bain-douche 4 trous sur gorge avec ensemble de douche
 Wannenrand bad und duschmischer
 Смеситель на борт ванны для 4 отверстий с ручным душем

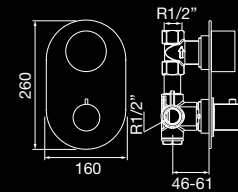

82 601 / 82 602 / 82 603 ●●●●

Termostático baño ducha empotrar con inversor 1/ 2/ 3 vías
 Thermostatic concealed bath shower with diverter 1/ 2/ 3 ways
 Mitigeur thermostatique bain/douche à encastrer avec inverseur 1/ 2/ 3 vois
 Thermostat für brause/wannenbatterie mit umstellung 1/ 2/ 3 abgängen
 Термостатический смеситель встроенный душ и ванна на 1/ 2/ 3 выхода

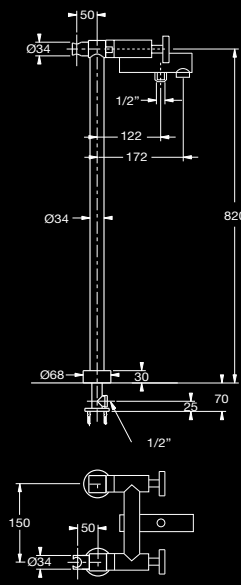

82 512 ●●●●

Grupo baño ducha con columna suelo de 820 mm
 Bath shower group with floor-standing column of 820 mm
 Mélangeur bain-douche sur colonne de 820 mm
 Wannen batterie mit 820 mm hohen boden anschluss,
 Handbrause und flexiblen schlauch
 Смеситель ванна / душ с напольными колоннами 820 mm

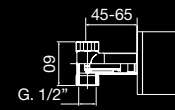
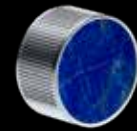

82 016 ●●●●

Llave de paso empotrar 1/2\"/>
 Built-in key step 1/2\"/>
 Robinet d'arrêt de 1/2\"/>
 Unterputz-ventil 1/2\"/>
 Кран встроенный 1/2\"/>

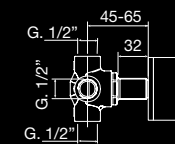
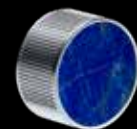

82 320 / 82 330 / 82 340 / 82 350 ●●●●

Distribuidor empotrar 2/3/4/5 salidas
 Built-in diverter 2/3/4/5 ways
 Inverseur 2/3/4/5 voies à encastrer
 2/3/4/5-wege-umsteller
 Встроенный дивертер на 2/3/4 /5 выхода

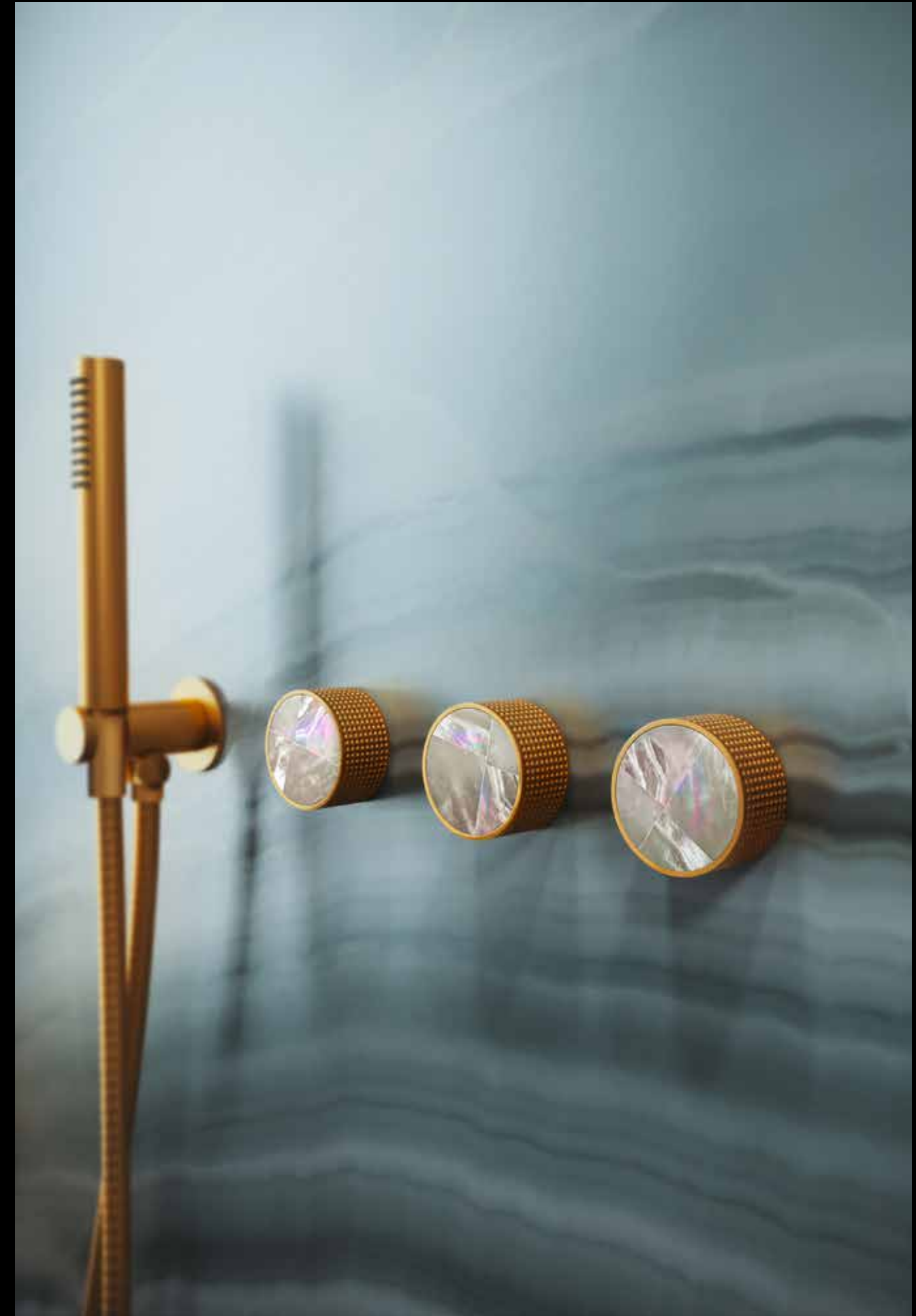

83 Clodette



Clodette



El suspiro de la naturaleza, la flor que captura la luz.
Clodette se inspira en la delicadeza de una flor en su máximo esplendor, un homenaje a la belleza efímera que solo la naturaleza puede otorgar. Las suaves líneas de sus pétalos, resplandecientes en cada acabado, evocan el susurro de la brisa entre las hojas. En el corazón de cada pieza, un cristal de Swarovski armoniza con el tono de su acabado y refleja la luz como un destello puro.

The sigh of nature, the flower that captures the light.
Clodette is inspired by the delicacy of a flower at its best, a tribute to the ephemeral beauty that only nature can confer. The soft lines of its petals, shining in each finish, evoke the whisper of a breeze among the leaves. At the heart of each piece, a Swarovski crystal harmonises with the tone of its finish and reflects the light like a pure sparkle.

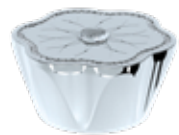

CR
Cromo
Chrome
Chrome
Chrom
Хром



NG
Negro mate
Matt black
Noir mate
Schwarz matte
Черное



OM
Oro mate
Matt gold
Or mat
Matt gold
Матовое золото



RM
Rosa mate
Matt rose
Rose mat
Matt rosa
Матовый розовый



OC
Oro cepillado
Brushed gold
Or brossé
Gebürstetes gold
Брашированное золото

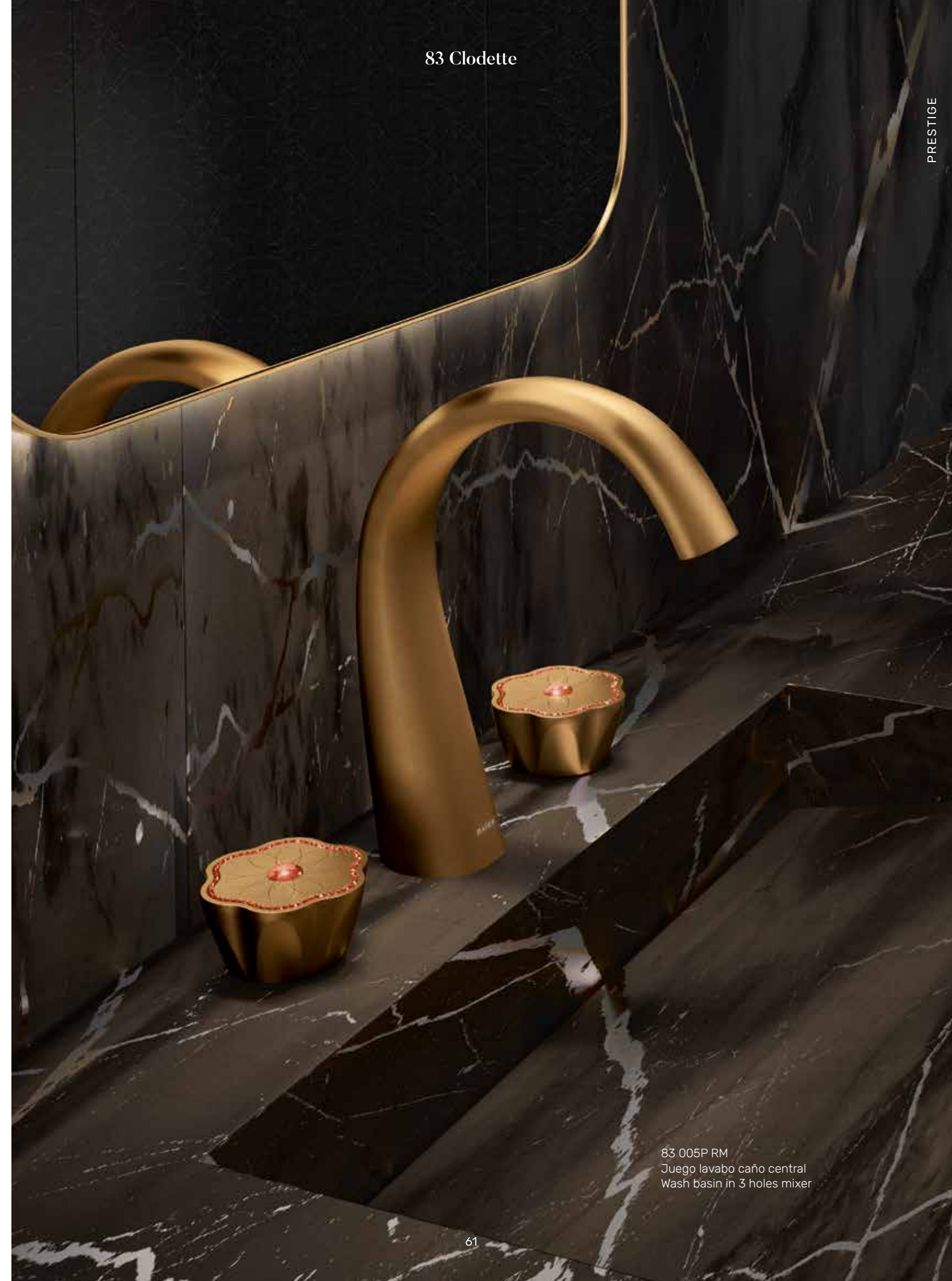

83 005P RM
Juego lavabo caño central
Wash basin in 3 holes mixer



Swarovski® is a registered trademark of Swarovski AG

83 005J NG
Juego lavabo caño central
Wash basin in 3 holes mixer

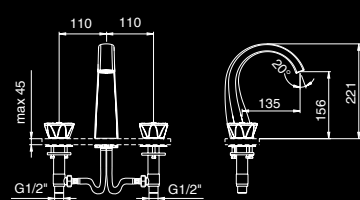

83 005P ●●●●●●

Juego lavabo caño central
Wash basin in 3 holes mixer
Mélangeur 3 trous pour lavabo
Waschtischmischer dreilochbatterie
Смеситель для раковины на 3 отверстия

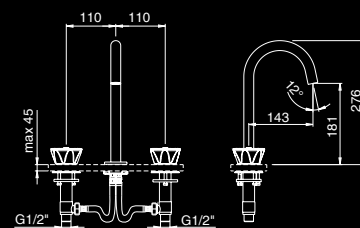

83 005J ●●●●●●

Juego lavabo caño central
Wash basin in 3 holes mixer
Mélangeur 3 trous pour lavabo
Waschtischmischer dreilochbatterie
Смеситель для раковины на 3 отверстия

83 075P ●●●●●●

Juego lavabo caño central válv. desag. click-clack
Wash basin in 3 holes mixer with click-clack waste
Mélangeur 3 trous pour lavabo avec vidage click-clack
Waschtischmischer dreilochbatterie mit click-clack ablauf
Смеситель для раковины на 3 отверстия с клапаном клик-клак

83 075J ●●●●●●

Juego lavabo caño central válv. desag. click-clack
Wash basin in 3 holes mixer with click-clack waste
Mélangeur 3 trous pour lavabo avec vidage click-clack
Waschtischmischer dreilochbatterie mit click-clack ablauf
Смеситель для раковины на 3 отверстия с клапаном клик-клак

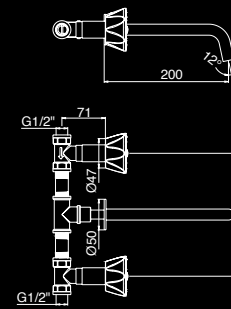

83 305 ●●●●●●

Bimando lavabo empotrado
Concealed 3 holes wash basin mixer
Mélangeur de lavabo 3 trous à encastrer
Unterputz 3-Loch Waschtischmischer
Встроенный смеситель для раковины на 3 отверстия

83 307 ●●●●●●

Bimando lavabo empotrado válvula desagüe click-clack
Concealed 3 holes wash basin mixer with click-clack waste
Mélangeur de lavabo 3 trous à encastrer avec vidage click-clack
Unterputz 3-Loch Waschtischmischer mit Click-Clack Ablaufgarnitur
Встроенный смеситель для раковины на 3 отверстия со сливом клик-клак

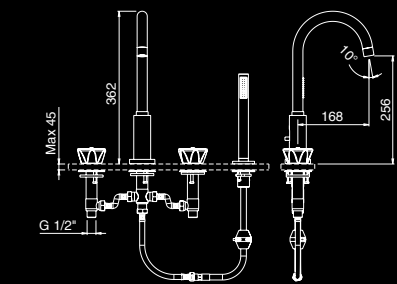

83 714J ●●●●●●

Grupo baño ducha 4 agujeros de repisa con ducha
Bath shower 4 holes mixer with handshower
Ensemble bain-douche 4 trous sur gorge avec ensemble de douche
Wannenrand bad und duschmischer
Смеситель на борт ванны для 4 отверстий с ручным душем

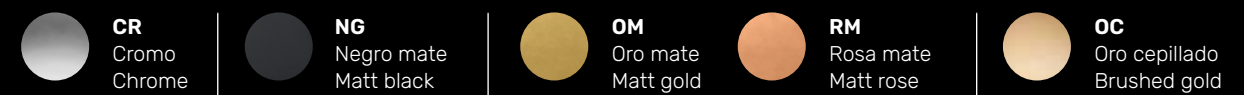



83 005P OC
Juego lavabo caño central
Wash basin in 3 holes mixer

MAIER



83 Clodette

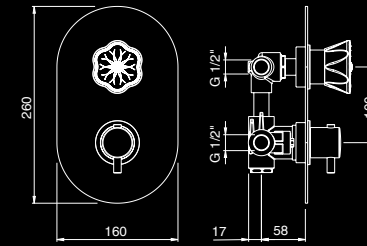

83 601 / 83 602 / 83 603 ●●●●●

Termostático baño ducha empotrar con inversor 1/ 2/ 3 vías
 Thermostatic concealed bath shower with diverter 1/ 2/ 3 ways
 Mitigeur thermostatique bain/douche à encastrer avec inverseur 1/ 2/ 3 voies
 Thermostat für brause/wannenbatterie mit umstellung 1/ 2/ 3 abgängen
 Термостатический смеситель встроенный душ и ванна на 1/ 2/ 3 выхода

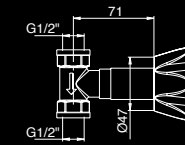
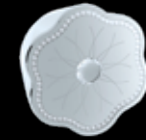

83 016 ●●●●●

Llave de paso empotrar 1/2"
 Built-in key step 1/2"
 Robinet d'arrêt de 1/2"
 Unterputz-ventil 1/2"
 Кран встроенный 1/2"

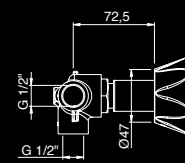

83 320 / 83 330 / 83 340 / 83 350 ●●●●●

Distribuidor empotrar 2/3/4/5 salidas
 Built-in diverter 2/3/4/5 ways
 Inverseur 2/3/4/5 voies à encastrer
 2/3/4/5-wege-umsteller
 Встроенный дивертер на 2/3/4 /5 выхода

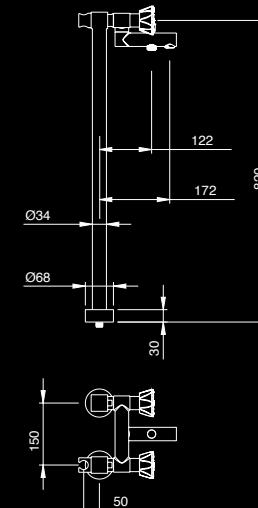

83 512 ●●●●●

Grupo baño ducha con columna suelo de 820 mm con accesorios.
 Bath shower group with floorstanding column of 820 mm with accessories.
 Mélangeur bain-douche sur colonne de 820 mm avec accessoires.
 Wannenbatterie mit 820 mm hohen boden mit zubehör.
 Смеситель ванна / душ с напольными колоннами 820 mm с аксессуарами.

CR
 Cromo
 Chrome

NG
 Negro mate
 Matt black

OM
 Oro mate
 Matt gold

RM
 Rosa mate
 Matt rose

OC
 Oro cepillado
 Brushed gold

73 Iceberg



Iceberg



Alma glacial. Una colección desprendida de un glaciar de gélida creatividad. Muestra radiantemente la elegancia de la montaña de hielo y esconde el meticuloso trabajo de un cristal forjado durante milenios.

A glacial soul. A collection detached from a glacier of frozen creativity. Radiantly shows the elegance of the ice mountain, and hides a meticulous work of a crystal forged for millennia.

CR
Cromo
Chrome
Chrome
Chrom
Хром

O
Oro
Gold
Or
Gold
Золото

OR
Oro rosa
Rose gold
Or rosé
Rose Gold
Розовое золото

OC
Oro cepillado
Brushed gold
Or brossé
Gebürstetes gold
Брашированное золото



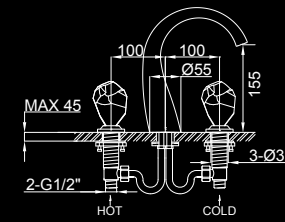

73 005P

Juego lavabo caño central
Wash basin in 3 holes mixer
Mélangeur 3 trous pour lavabo
Waschtischmischer dreilochbatterie
Смеситель для раковины на 3 отверстия

73 075P

Juego lavabo caño central válv. desag. click-clack
Wash basin in 3 holes mixer with click-clack waste
Mélangeur 3 trous pour lavabo avec vidage click-clack
Waschtischmischer dreilochbatterie mit click-clack ablauf
Смеситель для раковины на 3 отверстия с клапаном клик-клик

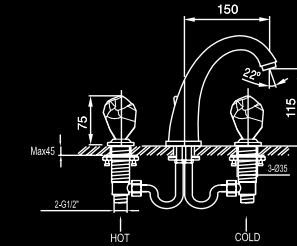

73 005M

Juego lavabo caño central
Wash basin in 3 holes mixer
Mélangeur 3 trous pour lavabo
Waschtischmischer dreilochbatterie
Смеситель для раковины на 3 отверстия

73 075M

Juego lavabo caño central válv. desag. click-clack
Wash basin in 3 holes mixer with click-clack waste
Mélangeur 3 trous pour lavabo avec vidage click-clack
Waschtischmischer dreilochbatterie mit click-clack ablauf
Смеситель для раковины на 3 отверстия с клапаном клик-клик

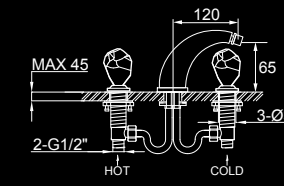

73 006M

Juego bidé caño central
Bidet in 3 holes mixer
Mélangeur 3 trous pour bidet
Bidetbatterie dreilochbatterie
Смеситель для биде на 3 отверстия

73 008M

Juego bidé caño central válv. desag. click-clack
Bidet in 3 holes mixer with click-clack waste
Mélangeur 3 trous pour bidet avec vidage click-clack
Bidetbatterie dreilochbatterie mit click-clack ablauf
Смеситель для биде на 3 отверстия с клапаном клик-клик



73 305

Bimando lavabo empotrado
Concealed 3 holes wash basin mixer
Mélangeur de lavabo 3 trous à encastrer
Unterputz 3-Loch Waschtischmischer
Встроенный смеситель для раковины на 3 отверстия

73 307

Bimando lavabo empotrado válv. desag. click-clack
Concealed 3 holes wash basin mixer with click-clack waste
Mélangeur de lavabo 3 trous à encastrer avec vidage click-clack
Unterputz 3-Loch Waschtischmischer mit Click-Clack Ablaufgarnitur
Встроенный смеситель для раковины на 3 отверстия со сливом click-clack

73 005P CR
Juego lavabo caño central
Wash basin in 3 holes mixer

- CR**
Cromo
Chrome
- O**
Oro
Gold
- OR**
Oro Rosa
Rose Gold
- OC**
Oro cepillado
Brushed gold



73 012 ●●●●●

Grupo baño ducha con accesorios
Wall mounted bath shower mixer with accessories
Mélangeur bain-douche avec accessoires
Wannen und dusch batterie mit zuberhör
Смеситель ванна / душ настенного монтажа с аксессуарами

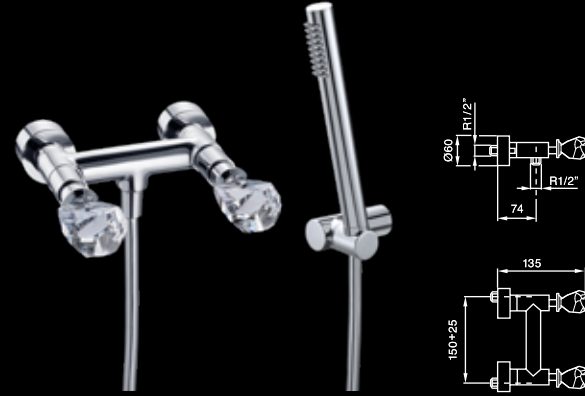

73 015 ●●●●●

Grupo ducha con accesorios
Shower mixer with accessories
Mélangeur douche avec ensemble de douche
Dusch batterie mit zuberhör
Смеситель для душа настенного монтажа с аксессуарами

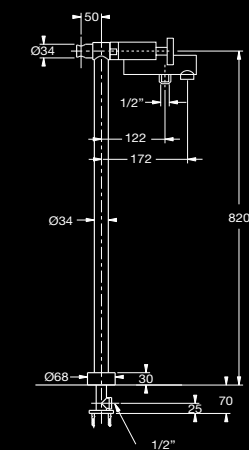
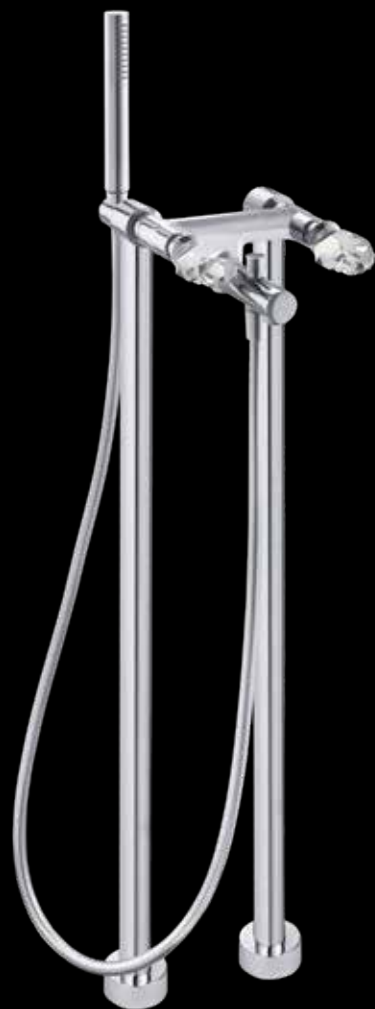

73 512 ●●●●●

Grupo baño ducha con columna suelo de 820 mm
Bath shower group with floor-standing column of 820 mm
Mélangeur bain-douche sur colonne de 820 mm
Wannen batterie mit 820 mm hohen boden anschluss,
Handbrause und flexiblen schlauch
Смеситель ванна / душ с напольными колоннами 820 mm

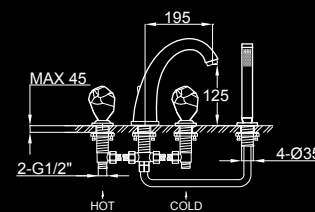

73 714M ●●●●●

Grupo baño ducha 4 agujeros de repisa con ducha
Bath shower 4 holes mixer with handshower
Ensemble bain-douche 4 trous sur gorge avec ensemble de douche
Wannenrand bad und duschmischer
Смеситель на борт ванны для 4 отверстий с ручным душем



73 016 ●●●●●

Llave de paso empotrar 1/2"
Built-in key step 1/2"
Robinet d'arrêt de 1/2"
Unterputz-ventil 1/2"
Кран встроенный 1/2"



73 320 / 73 330 / 73 340 / 73 350 ●●●●●

Distribuidor empotrar 2/3/4/5 salidas
Built-in diverter 2/3/4/5 ways
Inverseur 2/3/4/5 voies à encastrer
2/3/4/5-wege-umsteller
Встроенный дивертер на 2/3/4 /5 выхода



79 Murano



Murano



La isla de cristal. Navegando por la laguna veneciana, emerge una colección sofisticada con denominación de origen. Seis burbujas de cristal con oro o plata trasladan al baño la tradición artesanal y las técnicas avanzadas de los vidrieros de Murano.

The crystal island. Navigating the Venetian lagoon, a sophisticated collection of unique cuttings emerges. Six jewels of glass with gold or silver transfer to the bathroom the tradition of the glass masters of Murano.

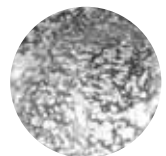

CR/LS
Cromo / Liso
Chrome / Plain

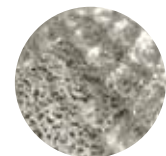

CR/RB
Cromo / Rombo
Chrome / Rhombic

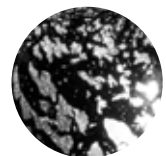

CR/NG
Cromo / Negro
Chrome / Black



O/LS
Oro / Liso
Gold / Plain



O/NG
Oro / Negro
Gold / Black

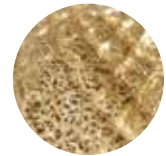

O/RB
Oro / Rombo
Gold / Rhombic



CR
Cromo
Chrome
Chrom
Хром



O
Oro
Gold
Or
Gold
Золото



OC
Oro cepillado
Brushed gold
Or brossé
Gebürstetes gold
Брашированное золото



79 005P O/NG
Juego lavabo caño central
Wash basin in 3 holes mixer



79 002 CR/NG
Monobloc lavabo
Single-hole wash-basin mixer

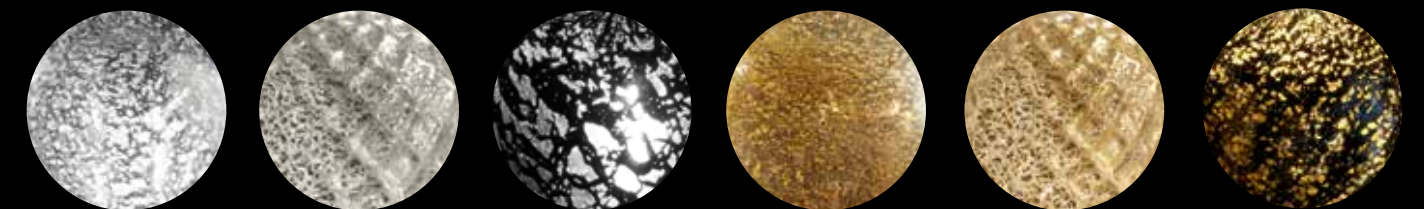

CR/LS

Cromo / Liso
Chrome / Plain

CR/RB

Cromo / Rombo
Chrome / Rhombic

CR/NG

Cromo / Negro
Chrome / Black

O/LS

Oro / Liso
Gold / Plain

O/RB

Oro / Rombo
Gold / Rhombic

O/NG

Oro / Negro
Gold / Black

OC/LS

Oro cepillado / Liso
Brushed gold / Plain

OC/RB

Oro cepillado / Rombo
Brushed gold / Rhombic

OC/NG

Oro cepillado / Negro
Brushed gold / Black

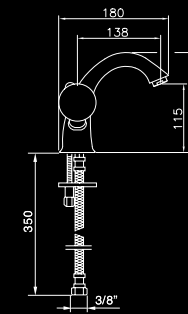

79 002 ● ● ● ●

Monobloc lavabo
Single-hole wash-basin mixer
Mélangeur lavabo monotrou
1-loch-zweigriff-waschtischbatterie
Смеситель для раковины

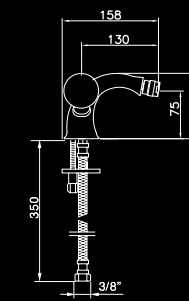

79 009 ● ● ● ●

Monobloc bidé
Single-hole bidet mixer
Mélangeur bidet monotrou
Bidetbatterie
Смеситель для биде

79 004 ● ● ● ●

Monobloc lavabo válv. desag. click-clack
Single-hole wash-basin set with click-clack waste
Mélangeur lavabo monotrou avec vidage click-clack
1-loch-zweigriff-waschtischbatterie mit click-clack ablauf
Смеситель для раковины с клапаном клик-клак

79 011 ● ● ● ●

Monobloc bidé válv. desag. click-clack
Single-hole bidet mixer with click-clack waste
Mélangeur bidet avec vidage click-clack
Bidetbatterie. Click-clack ablauf
Смеситель для биде с клапаном клик-клак

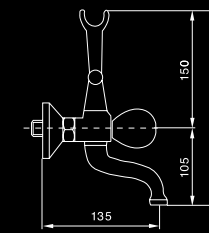

79 112 ● ● ● ●

Grupo baño ducha con accesorios
Wall mounted bath shower mixer with accessories
Mélangeur bain-douche avec accessoires
Wannen und dusch batterie
Смеситель настенный ванна / душ с аксессуарами

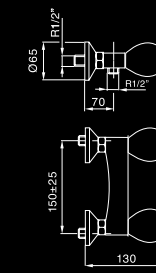

79 015 ● ● ● ●

Grupo ducha con accesorios
Shower mixer with accessories
Mélangeur douche avec ensemble de douche
Dusch batterie mit zuberhör
Смеситель для душа настенного монтажа с аксессуарами

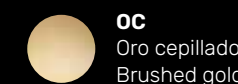

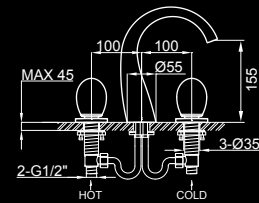

79 005P ●●●●

Juego lavabo caño central
Wash basin in 3 holes mixer
Mélangeur 3 trous pour lavabo
Waschtischmischer dreilochbatterie
Смеситель для раковины на 3 отверстия

79 075P ●●●●

Juego lavabo caño central válv. desag. click-clack
Wash basin in 3 holes mixer with click-clack waste
Mélangeur 3 trous pour lavabo avec vidage click-clack
Waschtischmischer dreilochbatterie mit click-clack ablauf
Смеситель для раковины на 3 отверстия с клапаном клик-клак

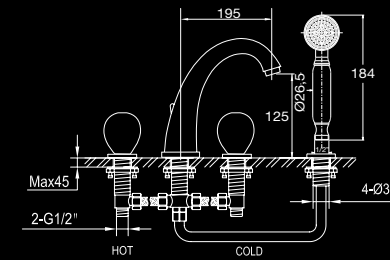

79 714M ●●●●

Grupo baño ducha 4 agujeros de repisa con ducha
Bath shower 4 holes mixer with handshower
Ensemble bain-douche 4 trous sur gorge avec ensemble de douche
Wannenrand bad und duschmischer
Смеситель на борт ванны для 4 отверстий с ручным душем

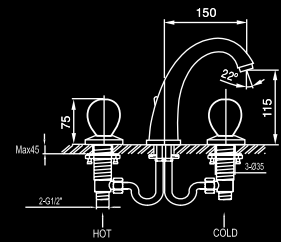

79 005M ●●●●

Juego lavabo caño central
Wash basin in 3 holes mixer
Mélangeur 3 trous pour lavabo
Waschtischmischer dreilochbatterie
Смеситель для раковины на 3 отверстия

79 075M ●●●●

Juego lavabo caño central válv. desag. click-clack
Wash basin in 3 holes mixer with click-clack waste
Mélangeur 3 trous pour lavabo avec vidage click-clack
Waschtischmischer dreilochbatterie mit click-clack ablauf
Смеситель для раковины на 3 отверстия с клапаном клик-клак

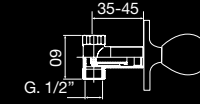

79 016 ●●●●

Llave de paso empotrar 1/2"
Built-in key step 1/2"
Robinet d'arrêt de 1/2"
Unterputz-ventil 1/2"
Кран встроенный 1/2"

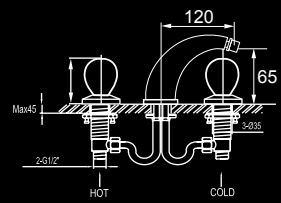

79 006M ●●●●

Juego bidé caño central
Bidet in 3 holes mixer
Mélangeur 3 trous pour bidet
Bidetbatterie dreilochbatterie
Смеситель для биде на 3 отверстия

79 008M ●●●●

Juego bidé caño central válv. desag. click-clack
Bidet in 3 holes mixer with click-clack waste
Mélangeur 3 trous pour bidet avec vidage click-clack
Bidetbatterie dreilochbatterie mit click-clack ablauf
Смеситель для биде на 3 отверстия с клапаном клик-клак

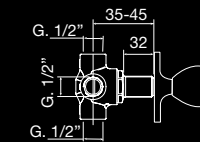

79 320 / 79 330 / 79 340 / 79 350 ●●●●

Distribuidor empotrar 2/3/4/5 salidas
Built-in diverter 2/3/4/5 ways
Inverseur 2/3/4/5 voies à encastrer
2/3/4/5-wege-umsteller
Встроенный дивертер на 2/3/4/5 выхода

79 419-M200 ●●●●

Columna ducha clásica cilíndrica telescópica con rociador M200 con desviador
Round telescopic classic shower column with showerhead M200 with diverter
Barre de douche ronde télescopique classique avec pomme de douche M200 et inverseur
Klassisch runde brausegarmitur M200 bewegliche kopfbrause handbrause, brausehalter und umschalter
Колонна душ цилиндрический телескопический с распылителем M200, с отклонением

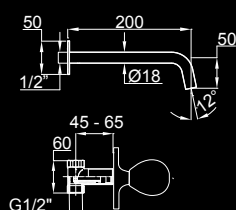

79 305 ●●●●

Bimando lavabo empotrado
Concealed 3 holes wash basin mixer
Mélangeur de lavabo 3 trous à encastrer
Unterputz 3-Loch Waschtischmischer
Встроенный смеситель для раковины на 3 отверстия

79 307 ●●●●

Bimando lavabo empotrado válv. desag click-clack
Concealed 3 holes wash basin mixer with click-clack waste
Mélangeur de lavabo 3 trous à encastrer avec vidage click-clack
Unterputz 3-Loch Waschtischmischer mit click-clack Ablaufgarmitur
Встроенный смеситель для раковины на 3 отверстия со сливом click-clack





79 005P CR/NG
Juego lavabo caño central
Wash basin in 3 holes mixer

78 Kryos



Kryos



El paradigma de cristal. Un tramado piramidal convertirá su baño en un lugar para recordar. Un interior con transparencias matizadas para transformar su estilo de vida. Un grifo de alta costura como una afirmación de su personalidad y sensibilidad.

The crystal paradigm. A pyramidal dithering will convert your bathroom in a place to remember. An interior with nuanced transparencies to transform your lifestyle. An haute couture faucet as an affirmation of your personality and sensitivity.

CR
Cromo
Chrome
Chrome
Chrom
Хром

O
Oro
Gold
Or
Gold
Золото

OR
Oro rosa
Rose gold
Or rosé
Rose Gold
Розовое золото

OC
Oro cepillado
Brushed gold
Or brossé
Gebürstetes gold
Брашированное золото



78 102 O
Monobloc lavabo alto
Single-hole high wash-basin



78 005M 0
Juego lavabo caño central
Wash basin in 3 holes mixer



78 005S OR
Juego lavabo caño central
Wash basin in 3 holes mixer



78 012 CR
Grupo baño ducha con accesorios
Wall mounted bath shower mixer with accessories

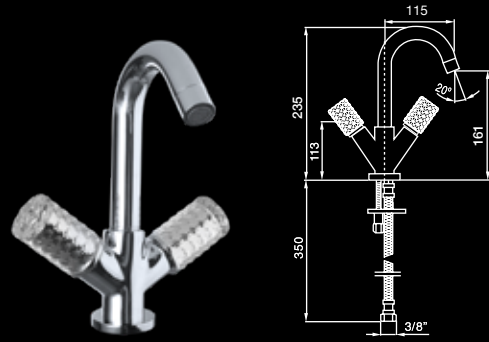

78 002 ●●●●●

Monobloc lavabo
Single-hole wash-basin mixer
Mélangeur lavabo monotrou
1-loch-zweigriff-waschtischbatterie
Смеситель для раковины

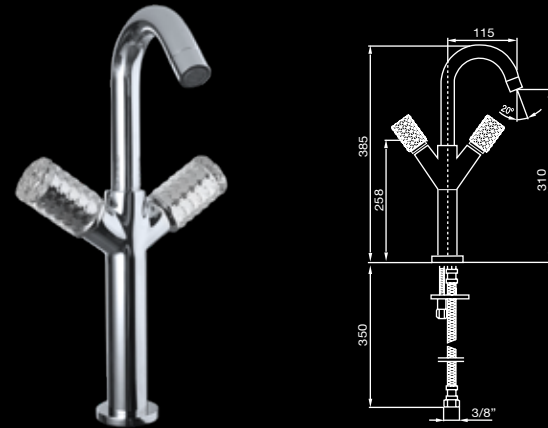

78 102 ●●●●●

Monobloc lavabo alto
Single-hole high wash-basin mixer
Mélangeur lavabo haut monotrou
1-loch-zweigriff-waschtischbatterie hoher
Высокий смеситель для раковины



78 305 ●●●●●

Bimando lavabo empotrado
Concealed 3 holes wash basin mixer
Mélangeur de lavabo 3 trous à encastrer
Unterputz 3-Loch Waschtischmischer
Встроенный смеситель для раковины на 3 отверстия



78 005S ●●●●●

Juego lavabo caño central
Wash basin in 3 holes mixer
Mélangeur 3 trous pour lavabo
Waschtischmischer dreilochbatterie
Смеситель для раковины на 3 отверстия

78 004 ●●●●●

Monobloc lavabo válv. desag. click-clack
Single-hole wash-basin set with click-clack waste
Mélangeur lavabo monotrou avec vidage click-clack
1-loch-zweigriff-waschtischbatterie mit click-clack ablauf
Смеситель для раковины с клапаном клик-клак

78 104 ●●●●●

Monobloc lavabo alto válv. desag. click-clack
Single-hole high wash-basin set with click-clack waste
Mélangeur lavabo haut monotrou avec vidage click-clack
1-loch-zweigriff-waschtischbatterie hoher mit click-clack ablauf
Высокий смеситель для раковины с клапаном клик-клак

78 307 ●●●●●

Bimando lavabo empotrado válv. desag. click-clack
Concealed 3 holes wash basin mixer with click-clack waste
Mélangeur de lavabo 3 trous à encastrer avec vidage click-clack
Unterputz 3-Loch Waschtischmischer mit click-clack Ablaufgarnitur
Встроенный смеситель для раковины на 3 отверстия со сливом click-clack

78 075S ●●●●●

Juego lavabo caño central válv. desag. click-clack
Wash basin in 3 holes mixer with click-clack waste
Mélangeur 3 trous pour lavabo avec vidage click-clack
Waschtischmischer dreilochbatterie mit click-clack ablauf
Смеситель для Раковины на 3 отверстия с клапаном клик-клак

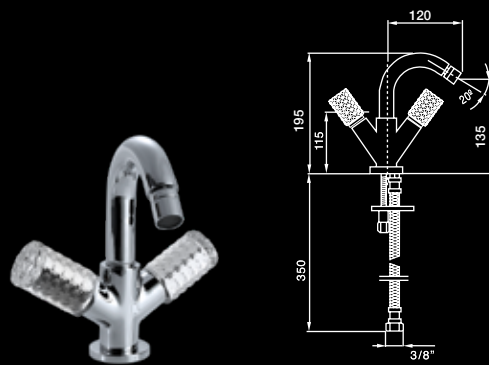

78 009 ●●●●●

Monobloc bidé
Single-hole bidet
Mélangeur bidet
Bidetbatterie
Смеситель для биде



78 005M ●●●●●

Juego lavabo caño central
Wash basin in 3 holes mixer
Mélangeur 3 trous pour lavabo
Waschtischmischer dreilochbatterie
Смеситель для раковины на 3 отверстия



78 012 ●●●●●

Grupo baño ducha con accesorios
Wall mounted bath shower mixer with accessories
Mélangeur bain-douche avec accessoires
Wannen und dusch batterie mit zuberhör
Смеситель ванна / душ настенного монтажа с аксессуарами



78 015 ●●●●●

Grupo ducha con accesorios
Shower mixer with accessories
Mélangeur douche avec ensemble de douche
Dusch batterie mit zuberhör
Смеситель для душа настенного монтажа с аксессуарами

78 011 ●●●●●

Monobloc bidé válv. desag. click-clack
Single-hole bidet set with click-clack waste
Mélangeur bidet avec vidage click-clack
Bidetbatterie. click-clack ablauf
Смеситель для биде с клапаном клик-клак

78 075M ●●●●●

Juego lavabo caño central válv. desag. click-clack
Wash basin in 3 holes mixer with click-clack waste
Mélangeur 3 trous pour lavabo avec vidage click-clack
Waschtischmischer dreilochbatterie mit click-clack ablauf
Смеситель для раковины на 3 отверстия с клапаном клик-клак



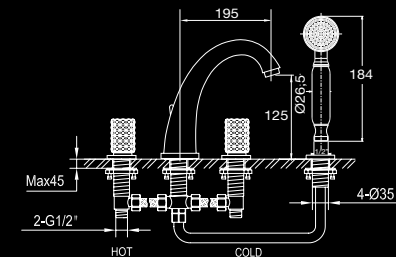
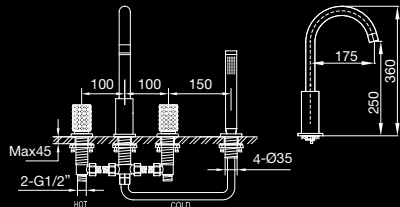

78 714 J ●●●●●

Grupo baño ducha 4 agujeros de repisa con ducha
Bath shower 4 holes mixer with handshower
Ensemble bain-douche 4 trous sur gorge avec ensemble de douche
Wannenrand bad und duschmischer
Смеситель на борт ванны для 4 отверстий с ручным душем

78 714 M ●●●●●

Grupo baño ducha 4 agujeros de repisa con ducha
Bath shower 4 holes mixer with handshower
Ensemble bain-douche 4 trous sur gorge avec ensemble de douche
Wannenrand bad und duschmischer
Смеситель на борт ванны для 4 отверстий с ручным душем

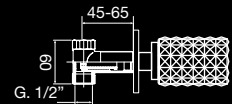
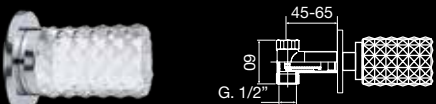

78 016 ●●●●●

Llave de paso empotrar 1/2"
Built-in key step 1/2"
Robinet d'arrêt de 1/2"
Unterputz-ventil 1/2"
Кран встроенный 1/2"

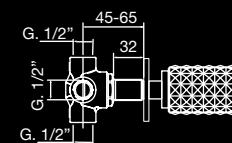
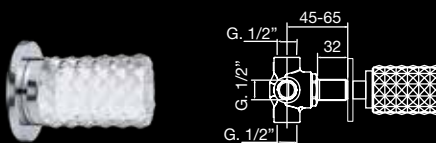

78 320 / 78 330 / 78 340 / 78 350 ●●●●●

Distribuidor empotrar 2/3/4/5 salidas
Built-in diverter 2/3/4/5 ways
Inverseur 2/3/4/5 voies à encastrer
2/3/4/5-wege-umsteller
Встроенный дивертер на 2/3/4/5 выхода

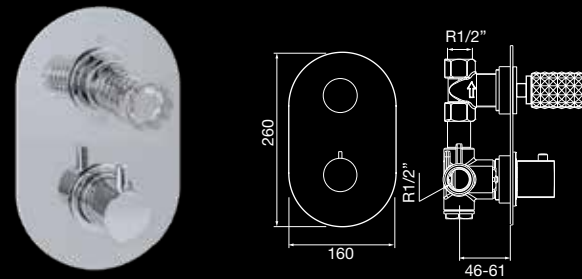

78 601 / 78 602 / 78 603 ●●●●●

Termostático baño ducha empotrar con inversor 1/ 2/ 3 vías
Thermostatic concealed bath shower with diverter 1/ 2/ 3 ways
Mitigeur thermostatique bain/douche à encastrer avec inverseur 1/ 2/ 3 vois
Thermostat für brause/wannenbatterie mit umstellung 1/ 2/ 3 abgängen
Термостатический смеситель встроенный / душ и ванна / на 1/ 2/ 3 выхода

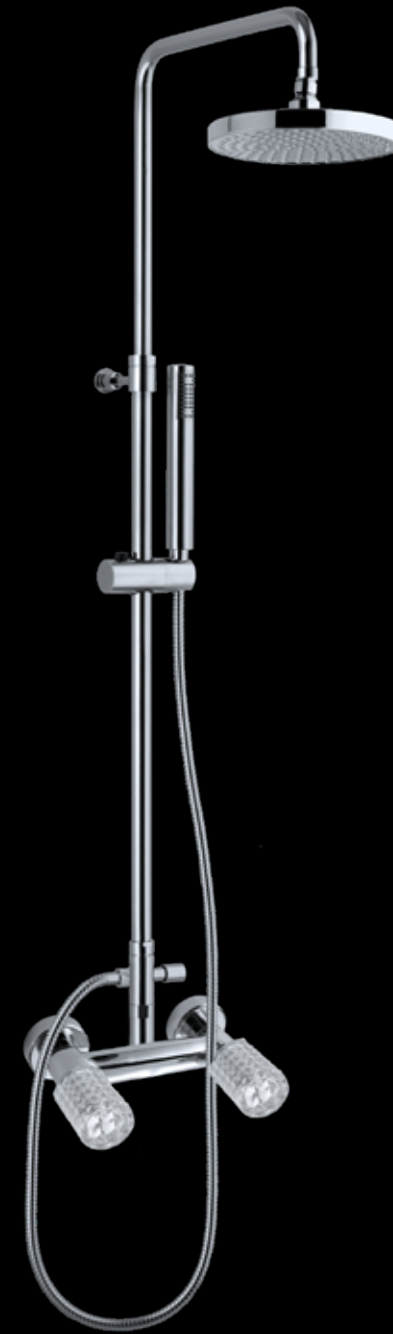

78 415-D200 ●●●●●

Columna ducha cilíndrica telescópica con rociador D200 con desviador
Round telescopic shower column with showerhead D200 with diverter
Barre de douche ronde télescopique avec pomme de douche D200 et inverseur
Runde brausegarnitur D200 bewegliche kopfbrause handbrause, brausehalter und umschalter
Душевая стойка цилиндрическая телескопическая с верхним душем d200

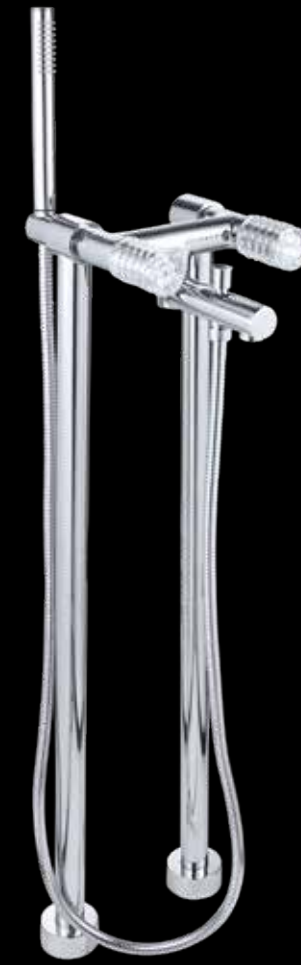

78 512 ●●●●●

Grupo baño ducha con columna suelo de 820 mm
Bath shower group with floor-standing column of 820 mm
Mélangeur bain-douche sur colonne de 820 mm
Wannen batterie mit 820 mm hohen boden anschluss, Handbrause und flexiblen schlauch
Смеситель ванна / душ с напольными колоннами 820 mm

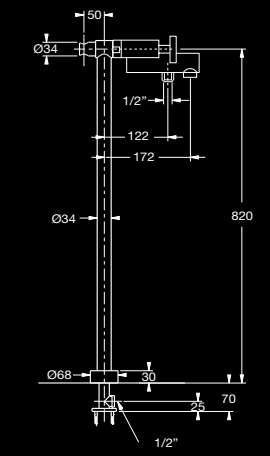

78 415-D300 ●●●●●

Ccolumna ducha cilíndrica telescópica con rociador D300 con desviador
Round telescopic shower column with showerhead D300 with diverter
B de douche ronde télescopique avec pomme de douche D300 et inverseur
Runde brausegarnitur D300 bewegliche kopfbrause handbrause, brausehalter und umschalter
Душевая стойка цилиндрическая телескопическая с верхним душем d300



77 Starlights



Starlights



Agua cristalizada. Cientos de partículas luminosas iluminan su sala de baño con el grifo joya Starlights. Sumérgase en un universo de brillantes estrellas, retenidas en los volantes como agua cristalizada hecha con Swarovski Elements.

Crystallized water. Hundreds of shiny particles illuminate your bathroom with the Starlights jewel faucet. Immerse yourself in a universe of shining stars, retained in the handles as crystallized water made with Swarovski Elements.

- | | | | |
|--|---|--|---|
| <p>CR
Cromo
Chrome
Chrom
Хром</p> | <p>O
Oro
Gold
Or
Gold
Золото</p> | <p>OR
Oro rosa
Rose gold
Or rosé
Rose Gold
Розовое золото</p> | <p>OC
Oro cepillado
Brushed gold
Or brossé
Gebürstetes gold
Брашированное золото</p> |
|--|---|--|---|



77 005S CR
Juego lavabo caño central
Wash basin in 3 holes mixer





77 002 ●●●●●

Monobloc lavabo
Single-hole wash-basin mixer
Mélangeur lavabo monotrou
1-loch-zweigriff-waschtischbatterie
Смеситель для раковины



77 102 ●●●●●

Monobloc lavabo alto
Single-hole high wash-basin
Mélangeur lavabo haut monotrou
1-loch-zweigriff-waschtischbatterie hoher
Высокий смеситель для раковины

77 004 ●●●●●

Monobloc lavabo válv. desag. click-clack
Single-hole wash-basin set with click-clack waste
Mélangeur lavabo avec vidage click-clack
Waschtischbatterie. Click-clack ablauf
Смеситель для раковины с клапаном клик-клак

77 104 ●●●●●

Monobloc lavabo alto válv. desag. click-clack
Single-hole high wash-basin set with click-clack waste
Mélangeur lavabo haut monotrou avec vidage click-clack
1-loch-zweigriff-waschtischbatterie hoher mit click-clack ablauf
Высокий смеситель для раковины с клапаном клик-клак

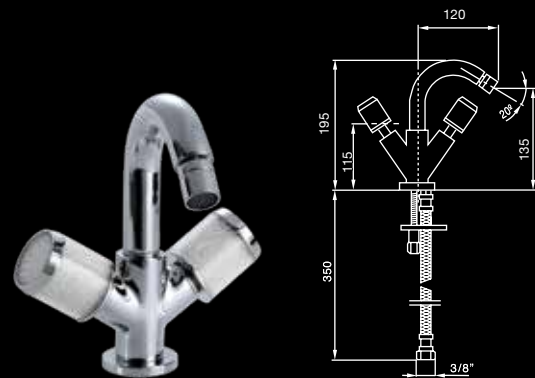

77 009 ●●●●●

Monobloc bidé
Single-hole bidet
Mélangeur bidet
Bidetbatterie
Смеситель для биде

77 011 ●●●●●

Monobloc bidé válv. desag. click-clack
Single-hole bidet set with click-clack waste
Mélangeur bidet avec vidage click-clack
Bidetbatterie. Click-clack ablauf
Смеситель для биде с клапаном клик-клак



77 305 ●●●●●

Bimando lavabo empotrado
Concealed 3 holes wash basin mixer
Mélangeur de lavabo 3 trous à encastrer
Unterputz 3-Loch Waschtischmischer
Встроенный смеситель для раковины на 3 отверстия

77 307 ●●●●●

Bimando lavabo empotrado válv. desag. click-clack
Concealed 3 holes wash basin mixer with click-clack waste
Mélangeur de lavabo 3 trous à encastrer avec vidage click-clack
Unterputz 3-Loch Waschtischmischer mit click-clack Ablaufgarnitur
Встроенный смеситель для раковины на 3 отверстия со сливом click-clack



77 005S ●●●●●

Juego lavabo caño central
Wash basin in 3 holes mixer
Mélangeur 3 trous pour lavabo
Waschtischmischer dreilochbatterie
Смеситель для раковины на 3 отверстия

77 075S ●●●●●

Juego lavabo caño central válv. desag. click-clack
Wash basin in 3 holes mixer with click-clack waste
Mélangeur 3 trous pour lavabo avec vidage click-clack
Waschtischmischer dreilochbatterie mit click-clack ablauf
Смеситель для Раковины на 3 отверстия с клапаном клик-клак





77 016 ●●●●●
 Llave de paso empotrar 1/2"
 Built-in key step 1/2"
 Robinet d'arrêt de 1/2"
 Unterputz-ventil 1/2"
 Кран встроенный 1/2"



77 320 / 77 330 / 77 340 / 77 350 ●●●●●
 Distribuidor empotrar 2/3/4/5 salidas
 Built-in diverter 2/3/4/5 ways
 Inverseur 2/3/4/5 voies à encastrer
 2/3/4/5-wege-umsteller
 Встроенный дивертер на 2/3/4/5 выхода

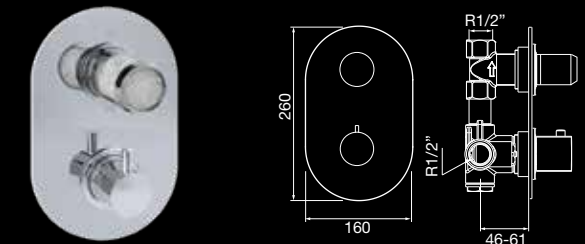

77 601 / 77 602 / 77 603 ●●●●●
 Termostático baño ducha empotrar con inversor 1/2/3 vías
 Thermostatic concealed bath shower with diverter 1/2/3 ways
 Mitigeur thermostatique bain/douche à encastrer avec inverseur 1/2/3 vois
 Thermostat für brause/wannenbatterie mit umstellung 1/2/3 abgängen
 Термостатический смеситель встроенный душ и ванна на 1/2/3 выхода



77 714J ●●●●●
 Grupo baño ducha 4 agujeros de repisa con ducha
 Bath shower 4 holes mixer with handshower
 Ensemble bain-douche 4 trous sur gorge avec ensemble de douche
 Wannenrand bad und duschmischer
 Смеситель на борт ванны для 4 отверстий с ручным душем



77 012 ●●●●●
 Grupo baño ducha con accesorios
 Wall mounted bath shower mixer with accessories
 Mélangeur bain-douche avec accessoires
 Wannen und dusch batterie mit zuberhör
 Смеситель ванна / душ настенного монтажа с аксессуарами



77 015 ●●●●●
 Grupo ducha con accesorios
 Shower mixer with accessories
 Mélangeur douche avec ensemble de douche
 Dusch batterie mit zuberhör
 Смеситель для душа настенного монтажа с аксессуарами



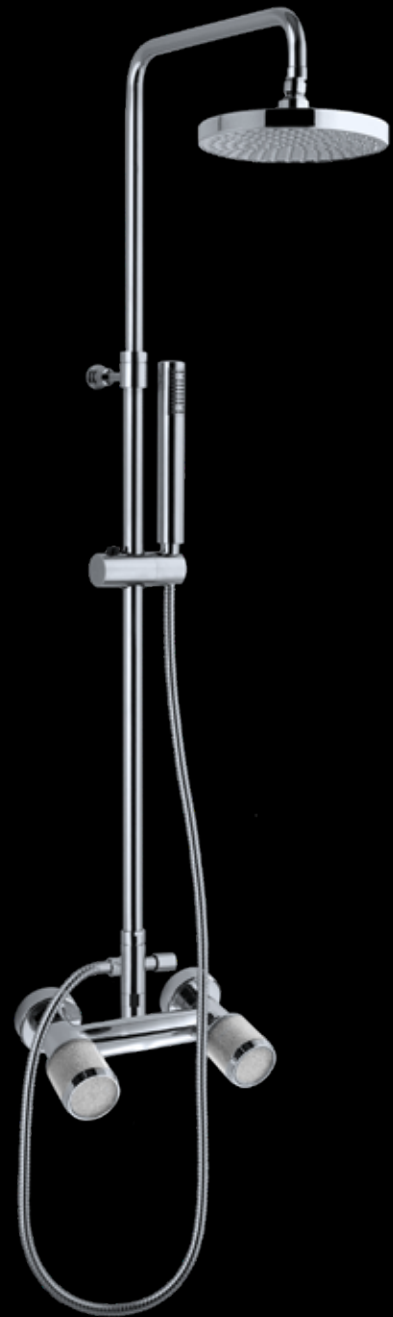

77 415-D200 ●●●●●

Columna ducha cilíndrica telescópica con rociador D200 con desviador
 Round telescopic shower column with showerhead D200 with diverter
 Barre de douche ronde télescopique avec pomme de douche D200 et inverseur
 Runde brausegarnitur D200 bewegliche kopfbrause handbrause, brausehalter und umschalter
 душевая стойка цилиндрическая телескопическая с верхним душем д200



77 512 ●●●●●

Grupo baño ducha con columnas suelo de 820 mm
 Bath shower group with floor-standing columns of 820 mm
 Mélangeur bain-douche sur colonnes de 820 mm
 Wannen batterie mit 820 mm hohen boden anschluss, handbrause und flexiblen schlauch
 Смеситель ванна / душ с напольными колоннами 820 mm

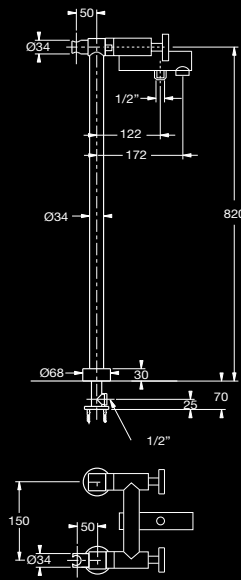

77 415-D300 ●●●●●

Columna ducha cilíndrica telescópica con rociador D300 con desviador
 Round telescopic shower column with showerhead D300 with diverter
 Barre de douche ronde télescopique avec pomme de douche D300 et inverseur
 Runde brausegarnitur D300 bewegliche kopfbrause handbrause, brausehalter und umschalter
 душевая стойка цилиндрическая телескопическая с верхним душем д300



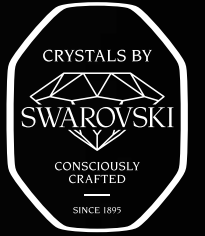

Swarovski® is a registered trademark of Swarovski AG

72 Artik



Artik



Reflejos Boreales. Embellezca su sala de baño e ilumínela con los encantadores reflejos polares del grifo Artik. Vaya más allá de la imaginación con este elegante modelo de formas únicas y perfectas.

Aurora Borealis reflections. Glamorize your bathroom and enrich it with the charming Artik faucet polar reflections. Go beyond imagination with this chic model of unique and perfect shapes.

- | | | | |
|---|---|--|---|
| <p>CR
Cromo
Chrome
Chrome
Chrom
Хром</p> | <p>O
Oro
Gold
Or
Gold
Золото</p> | <p>OR
Oro rosa
Rose gold
Or rosé
Rose Gold
Розовое золото</p> | <p>OC
Oro cepillado
Brushed gold
Or brossé
Gebürstetes gold
Брашированное золото</p> |
|---|---|--|---|



72 302 CR
Bimando lavabo empotrado
Concealed 3 holes wash basin mixer



ARTIK ROUND ACCESSORIES

pag. 422

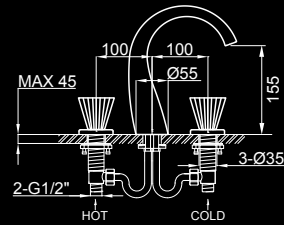

72 005P ●●●●●

Juego lavabo caño central
Wash basin in 3 holes mixer
Mélangeur 3 trous pour lavabo
Waschtischmischer dreilochbatterie
Смеситель для раковины на 3 отверстия

72 075P ●●●●●

Juego lavabo caño central válv. desag. click-clack
Wash basin in 3 holes mixer with click-clack waste
Mélangeur 3 trous pour lavabo avec vidage click-clack
Waschtischmischer dreilochbatterie mit click-clack ablauf
Смеситель для раковины на 3 отверстия с клапаном клик-клак

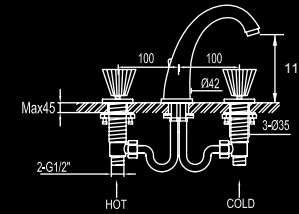

72 005M ●●●●●

Juego lavabo caño central
Wash basin in 3 holes mixer
Mélangeur 3 trous pour lavabo
Waschtischmischer dreilochbatterie
Смеситель для раковины на 3 отверстия

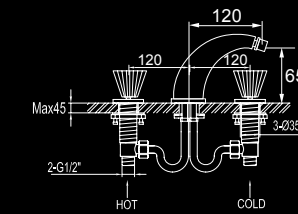

72 006M ●●●●●

Juego bidé caño central
Bidet in 3 holes mixer
Mélangeur 3 trous pour bidet
Bidetbatterie dreilochbatterie
Смеситель для биде на 3 отверстия

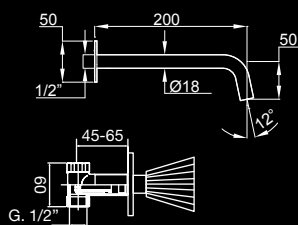

72 305 ●●●●●

Bimando lavabo empotrado
Concealed 3 holes wash basin mixer
Mélangeur de lavabo 3 trous à encastrer
Unterputz 3-Loch Waschtischmischer
Встроенный смеситель для раковины на 3 отверстия

72 307 ●●●●●

Bimando lavabo empotrado válv. desag. click-clack
Concealed 3 holes wash basin mixer with click-clack waste
Mélangeur de lavabo 3 trous à encastrer avec vidage click-clack
Unterputz 3-Loch Waschtischmischer mit click-clack Ablaufgarnitur
Встроенный смеситель для раковины на 3 отверстия со сливом клик-клак

72 075M ●●●●●

Juego lavabo caño central válv. desag. click-clack
Wash basin in 3 holes mixer with click-clack waste
Mélangeur 3 trous pour lavabo avec vidage click-clack
Waschtischmischer dreilochbatterie mit click-clack ablauf
Смеситель для раковины на 3 отверстия с клапаном клик-клак

72 008M ●●●●●

Juego bidé caño central válv. desag. click-clack
Bidet in 3 holes mixer with click-clack waste
Mélangeur 3 trous pour bidet avec vidage click-clack
Bidetbatterie dreilochbatterie mit click-clack ablauf
Смеситель для биде на 3 отверстия с клапаном клик-клак

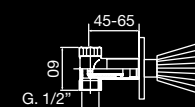

72 016 ●●●●●

Llave de paso empotrar 1/2"
Built-in key step 1/2"
Robinet d'arrêt de 1/2"
Unterputz-ventil 1/2"
Кран встроенный 1/2"

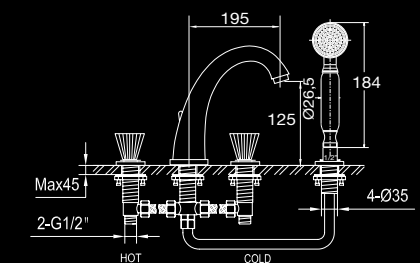

72 320 / 72 330 / 72 340 / 72 350 ●●●●●

Distribuidor empotrar 2/3/4/5 salidas
Built-in diverter 2/3/4/5 ways
Inverseur 2/3/4/5 voies à encastrer
2/3/4/5 -wege-umsteller
Встроенный дивертер на 2/3/4/5 выхода

72 714M ●●●●●

Grupo baño ducha 4 agujeros de repisa con ducha
Bath shower 4 holes mixer with handshower
Ensemble bain-douche 4 trous sur gorge avec ensemble de douche
Wannenrand bad und duschmischer
Смеситель на борт ванны для 4 отверстий с ручным душем

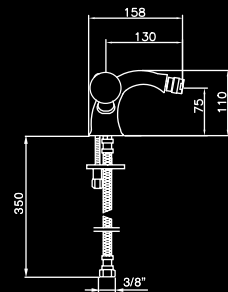

72 009 ●●●●●

Monobloc bidé
Single-hole bidet
Mélangeur bidet
Bidetbatterie
Смеситель для биде

72 011 ●●●●●

Monobloc bidé válv. desag. click-clack
Single-hole bidet set with click-clack waste
Mélangeur bidet avec vidage click-clack
Bidetbatterie. Click-clack ablauf
Смеситель для биде с клапаном клик-клак

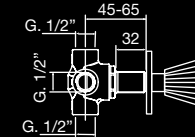
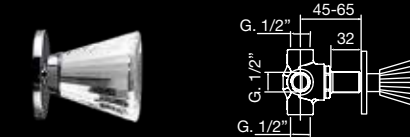



Swarovski® is a registered trademark of Swarovski AG

71 Rock



Rock



Brillante armonía. Rock le invita a combinar la precisión geométrica de sus formas asimétricas con la distinción clásica de los volantes de cristal y la más avanzada funcionalidad. Un trío que suena con brillantez en baños más exclusivos.

Brilliant harmony. Rock invites you to combine the asymmetric geometric precision of its shapes with the classical distinction of the crystal handles and the finest functionality. A trio that sounds brilliantly in exclusive bathrooms.

- | | | | |
|---|---|--|---|
| <p>CR
Cromo
Chrome
Chrome
Chrom
Хром</p> | <p>O
Oro
Gold
Or
Gold
Золото</p> | <p>OR
Oro rosa
Rose gold
Or rosé
Rose Gold
Розовое золото</p> | <p>OC
Oro cepillado
Brushed gold
Or brossé
Gebürstetes gold
Брашированное золото</p> |
|---|---|--|---|



71 005P O
Juego lavabo caño central
Wash basin in 3 holes mixer

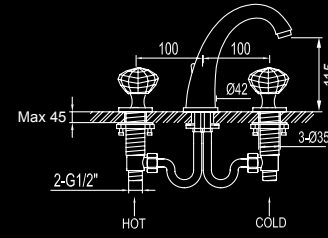
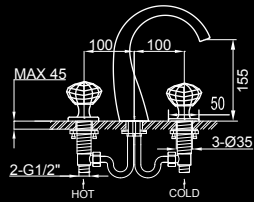

71 005P ●●●●●

Juego lavabo caño central
Wash basin in 3 holes mixer
Mélangeur 3 trous pour lavabo
Waschtischmischer dreilochbatterie
Смеситель для раковины на 3 отверстия

71 005M ●●●●●

Juego lavabo caño central
Wash basin in 3 holes mixer
Mélangeur 3 trous pour lavabo
Waschtischmischer dreilochbatterie
Смеситель для раковины на 3 отверстия

71 075P ●●●●●

Juego lavabo caño central válv. desag. click-clack
Wash basin in 3 holes mixer with click-clack waste
Mélangeur 3 trous pour lavabo avec vidage click-clack
Waschtischmischer dreilochbatterie mit click-clack ablauf
Смеситель для раковины на 3 отверстия с клапаном клик-клак

71 075M ●●●●●

Juego lavabo caño central válv. desag. click-clack
Wash basin in 3 holes mixer with click-clack waste
Mélangeur 3 trous pour lavabo avec vidage click-clack
Waschtischmischer dreilochbatterie mit click-clack ablauf
Смеситель для раковины на 3 отверстия с клапаном клик-клак



71 305 ●●●●●

Bimando lavabo empotrado
Concealed 3 holes wash basin mixer
Mélangeur de lavabo 3 trous à encastrer
Unterputz 3-Loch Waschtischmischer
Встроенный смеситель для раковины на 3 отверстия

71 307 ●●●●●

Bimando lavabo empotrado válv. desag. click-clack
Concealed 3 holes wash basin mixer with click-clack waste
Mélangeur de lavabo 3 trous à encastrer avec vidage click-clack
Unterputz 3-Loch Waschtischmischer mit click-clack Ablaufgarnitur
Встроенный смеситель для раковины на 3 отверстия со сливом клик-клак



71 005M CR
Juego lavabo caño central
Wash basin in 3 holes mixer

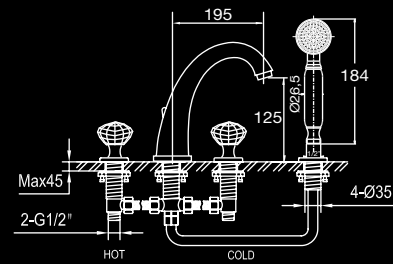
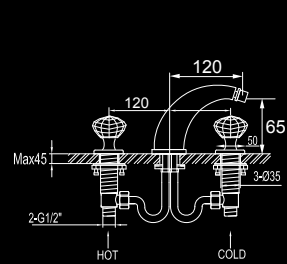

71 006M ●●●●●

Juego bidé caño central
 Bidet in 3 holes mixer
 Mélangeur 3 trous pour bidet
 Bidetbatterie dreilochbatterie
 Смеситель для биде на 3 отверстия

71 714M ●●●●●

Grupo baño ducha 4 agujeros de repisa con ducha
 Bath shower 4 holes mixer with handshower
 Ensemble bain-douche 4 trous sur gorge avec ensemble de douche
 Wannenrand bad und duschmischer
 Смеситель на борту ванны для 4 отверстий с ручным душем

71 008M ●●●●●

Juego bidé caño central válv. desag. click-clack
 Bidet in 3 holes mixer with click-clack waste
 Mélangeur 3 trous pour bidet avec vidage click-clack
 Bidetbatterie dreilochbatterie mit click-clack ablauf
 Смеситель для биде на 3 отверстия с клапаном клик-клак



71 016 ●●●●●

Llave de paso empotrar 1/2"
 Built-in key step 1/2"
 Robinet d'arrêt de 1/2"
 Unterputz-ventil 1/2"
 Кран встроенный 1/2"

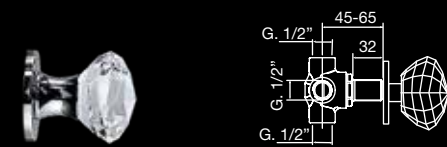

71 320 / 71 330 / 71 340 / 71 350 ●●●●●

Distribuidor empotrar 2/3/4/5 salidas
 Built-in diverter 2/3/4/5 ways
 Inverseur 2/3/4/5 voies à encastrer
 2/3/4/5 -wege-umsteller
 Встроенный дивертер на 2/3/4/5 выхода

- CR**
Cromo
Chrome
- O**
Oro
Gold
- OR**
Oro Rosa
Rose Gold
- OC**
Oro cepillado
Brushed gold



75 Klass

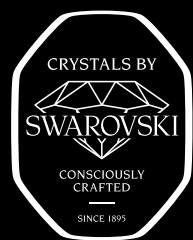

Swarovski® is a registered trademark of Swarovski AG

Klass



La joya de la corona. Este glamuroso grifo combina sofisticados detalles brillantes con un diseño exquisito y sensual. Una obra maestra meticulosamente embellecida con destellantes cristales Swarovski convirtiéndola en un símbolo en cualquier sala de baño de lujo.

The jewel of the crown. This glamorous mixer combines bright sophisticated details with exquisite sensual design. A masterpiece meticulously embellished with sparkling Swarovski crystal stones making it a symbol of any luxury bathroom.

- | | | | |
|---|---|--|---|
| <p>CR
Cromo
Chrome
Chrome
Chrom
Хром</p> | <p>O
Oro
Gold
Or
Gold
Золото</p> | <p>OR
Oro rosa
Rose gold
Or rosé
Rose Gold
Розовое золото</p> | <p>OC
Oro cepillado
Brushed gold
Or brossé
Gebürstetes gold
Брашированное золото</p> |
|---|---|--|---|



75 002 0
Monobloc lavabo
Single-hole wash-basin mixer



75 002 CR
Monobloc lavabo
Single-hole wash-basin mixer



75 016 CR / O/ OR/ OC
Llave de paso empotrar 1/2"
Built-in key step 1/2"



75 002 ●●●●●●
 Monobloc lavabo
 Single-hole wash-basin mixer
 Mélangeur lavabo monotrou
 1-loch-zweigriff-waschtischbatterie
 Смеситель для раковины



75 009 ●●●●●●
 Monobloc bidé
 Single-hole bidet
 Mélangeur bidet
 Bidet batterie
 Смеситель для биде

75 004 ●●●●●●
 Monobloc lavabo válv. desag. click-clack
 Single-hole wash-basin set with click-clack waste
 Mélangeur lavabo avec vidage click-clack
 Waschtischbatterie. Click-clack ablauf
 Смеситель для раковины с клапаном клик-клак

75 011 ●●●●●●
 Monobloc bidé válv. desag. click-clack
 Single-hole bidet set with click-clack waste
 Mélangeur bidet avec vidage click-clack
 Bidetbatterie. Click-clack ablauf
 Смеситель для биде с клапаном клик-клак



75 305 ●●●●●●
 Bimando lavabo empotrado
 Concealed 3 holes wash basin mixer
 Mélangeur de lavabo 3 trous à encastrer
 Unterputz 3-Loch Waschtischmischer
 Встроенный смеситель для раковины на 3 отверстия

75 307 ●●●●●●
 Bimando lavabo empotrado válv. desag. click-clack
 Concealed 3 holes wash basin mixer with click-clack waste
 Mélangeur de lavabo 3 trous à encastrer avec vidage click-clack
 Unterputz 3-Loch Waschtischmischer mit click-clack Ablaufgarnitur
 Встроенный смеситель для раковины на 3 отверстия со сливом клик-клак



75 016 ●●●●●●
 Llave de paso empotrar 1/2"
 Built-in key step 1/2"
 Robinet d'arrêt de 1/2"
 Unterputz-ventil 1/2"
 Кран встроенный 1/2"



75 320 / 75 330 / 75 340 / 75 350 ●●●●●●
 Distribuidor empotrar 2/3/4/5 salidas
 Built-in diverter 2/3/4/5 ways
 Inverseur 2/3/4/5 voies à encastrer
 2/3/4/5-wege-umsteller
 Встроенный дивертер на 2/3/4/5 выхода



75 419-M200 ●●●●●●
 Columna ducha clásica cilíndrica telescópica con rociador M200 con desviador
 Round telescopic classic shower column with showerhead M200 with diverter
 Barre de douche ronde télescopique classique avec pomme de douche M200 et inverseur
 Klassisch runde brausegarnitur M200 bewegliche kopfbrause handbrause, brausehalter und umschalter
 Колонна душ цилиндрический телескопический с распылителем M200, с отклонением

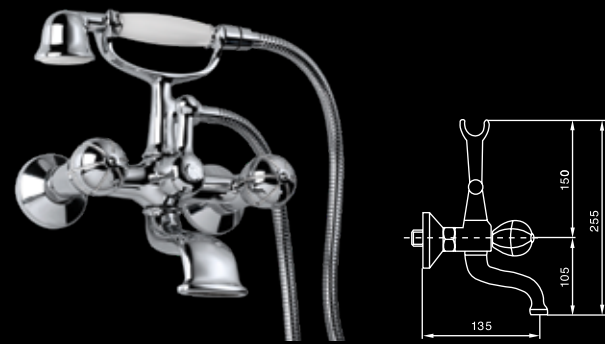

75 112 ●●●●●●
 Grupo baño ducha con accesorios
 Wall mounted bath shower mixer with accessories
 Mélangeur bain-douche avec accessoires
 Wannen und dusch batterie
 Смеситель настенный ванна / душ с аксессуарами



75 015 ●●●●●●
 Grupo ducha con accesorios
 Shower mixer with accessories
 Mélangeur douche avec ensemble de douche
 Dusch batterie mit zuberhör
 Смеситель для душа настенного монтажа с аксессуарами



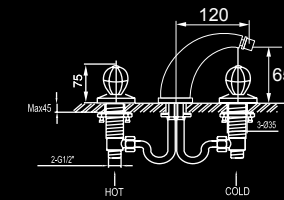
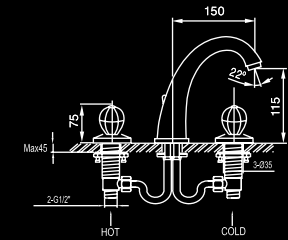
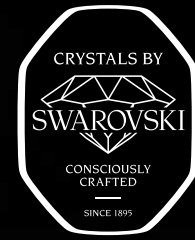

75 005M ●●●●●

Juego lavabo caño central
Wash basin in 3 holes mixer
Mélangeur 3 trous pour lavabo
Waschtischmischer dreilochbatterie
Смеситель для раковины на 3 отверстия

75 006M ●●●●●

Juego bidé caño central
Bidet in 3 holes mixer
Mélangeur 3 trous pour bidet
Bidetbatterie dreilochbatterie
Смеситель для биде на 3 отверстия

75 075M ●●●●●

Juego lavabo caño central válv. desag. click-clack
Wash basin in 3 holes mixer with click-clack waste
Mélangeur 3 trous pour lavabo avec vidage click-clack
Waschtischmischer dreilochbatterie mit click-clack ablauf
Смеситель для раковины на 3 отверстия с клапаном клик-клак

75 008M ●●●●●

Juego bidé caño central válv. desag. click-clack
Bidet in 3 holes mixer with click-clack waste
Mélangeur 3 trous pour bidet avec vidage click-clack
Bidetbatterie dreilochbatterie mit click-clack ablauf
Смеситель для биде на 3 отверстия с клапаном клик-клак

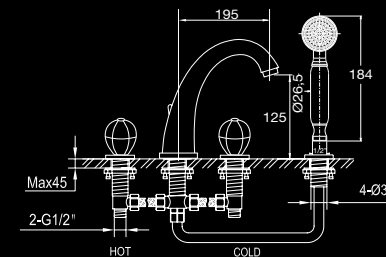

75 714M ●●●●●

Grupo baño ducha 4 agujeros de repisa con ducha
Bath shower 4 holes mixer with handshower
Ensemble bain-douche 4 trous sur gorge avec ensemble de douche
Wannenrand bad und duschmischer
Смеситель на борт ванны для 4 отверстий с ручным душем

- **CR**
Cromo
Chrome
- **O**
Oro
Gold
- **OR**
Oro Rosa
Rose Gold
- **OC**
Oro cepillado
Brushed gold

75 005M CR
Juego lavabo caño central
Wash basin in 3 holes mixer

59 Skip Diamond



Swarovski® is a registered trademark of Swarovski AG

Skip Diamond



Una línea de cristal. Colección de grifería elegante y sofisticada con un toque radiante. Skip Diamond está sutilmente decorada con dos finas líneas de cristales Swarovski, fijadas de forma segura a la maneta. Su diseño esbelto se distingue y destaca de entre lo ordinario.

A crystal line. Elegant and sophisticated bathroom faucet collection with a touch of bling. Skip Diamond is subtly decorated with a thin two-row of Swarovski crystals, securely fixed to the lever. Its svelte design distinguish itself and outstands from the ordinary.

CR
Cromo
Chrome
Chrome
Chrom
Хром

O
Oro
Gold
Or
Gold
Золото

OR
Oro rosa
Rose gold
Or rosé
Rose Gold
Розовое золото

OC
Oro cepillado
Brushed gold
Or brossé
Gebürstetes gold
Брашированное золото



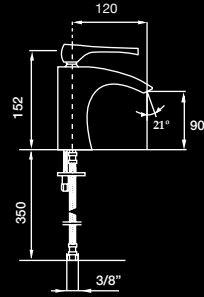

59 002 ●●●●●

Monomando lavabo
Wash-basin mixer
Mitigeur lavabo
Einhebel waschtischmischer
Однорычажный Смеситель для раковины

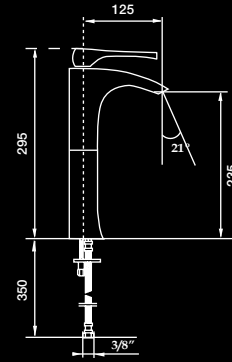

59 102 ●●●●●

Monomando lavabo alto
High wash-basin mixer
Mitigeur lavabo haut
Einhebel waschtischmischer. Hohemn ausführung
Однорычажный Смеситель для раковин высокий

59 004 ●●●●●

Monomando lavabo válv. desag. click-clack
Wash-basin mixer with click-clack waste
Mitigeur lavabo haut avec vidage click-clack
Einhebel waschtischmischer click-clack ablauf
Однорычажный смеситель для раковины с клапаном клик-клак

59 104 ●●●●●

Monomando lavabo alto válv. desag. click-clack
High wash-basin mixer with click-clack waste
Mitigeur lavabo haut avec vidage click-clack
Einhebel waschtischmischer. Hohemn ausführung mit click-clack ablauf
Однорычажный смеситель для раковины высокий с клапаном клик-клак

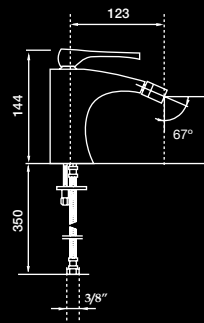

59 009 ●●●●●

Monomando bidé
Bidet mixer
Mitigeur bidet
Einhebel bidetmischer
Однорычажный смеситель для биде

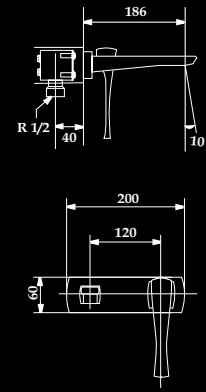

59 302 ●●●●●

Monomando lavabo empotrado
Built-in single-lever wash-basin mixer
Mitigeur lavabo mural à encastrer
Unterputz Einhebel wannenmischer
Однорычажный смеситель для раковины настенный встроенный

59 011 ●●●●●

Monomando bidé válv. desag. click-clack
Bidet mixer with click-clack waste
Mitigeur bidet avec vidage click-clack
Einhebel bidetmischer click-clack ablauf
Однорычажный смеситель для биде с клапаном клик-клак

59 304 ●●●●●

Monomando lavabo empotrado válv. desag. click-clack
Built-in single-lever wash-basin with click-clack waste
Mitigeur lavabo mural à encastrer avec vidage click-clack
Unterputz Einhebel wannenmischer. click-clack ablauf
Однорычажный смеситель для раковины настенный встроенный с коапаном клик-клак

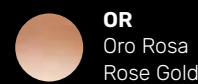
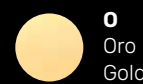
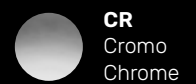

59 002 O
Monomando lavabo
Wash-basin mixer

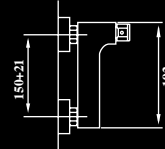
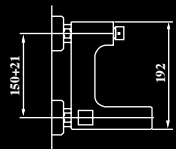
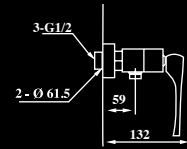
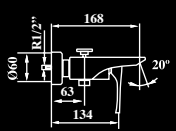

59 012 ●●●●●

Monomando baño ducha con accesorios
Bath and shower mixer with accessories
Mitigeur bain-douche avec accessoires
Einhebel wannen und duschmischer
Смеситель ванна / душ настенного монтажа с аксессуарами

59 015 ●●●●●

Monomando ducha con accesorios
Shower mixer with accessories
Mitigeur douche avec ensemble de douche
Einhebel duschmischer
Смеситель для душа настенного монтажа с аксессуарами

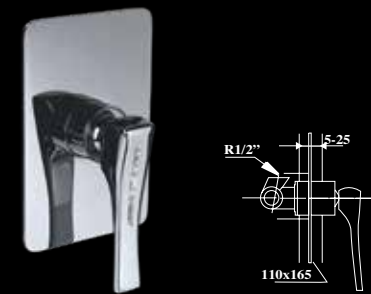
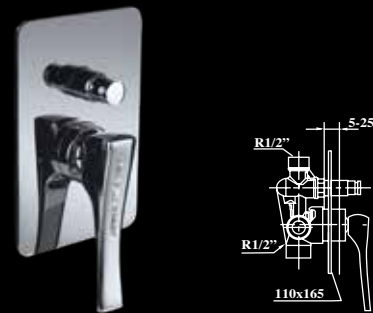

59 312 ●●●●●

Monomando empotrar baño ducha
Built-in bath shower mixer
Mitigeur bain-douche à encastrer
Unterputz wannen und duschmischer
Однорычажный Смеситель встроенный ванна душ

59 315 ●●●●●

Monomando empotrar ducha
Built-in shower mixer
Ensemble douche à encastrer
Unterputz duschmischer
Однорычажный Смеситель встроенный для душа



- CR**
Cromo
Chrome
- O**
Oro
Gold
- OR**
Oro Rosa
Rose Gold
- OC**
Oro cepillado
Brushed gold

59 012 CR
Monomando baño ducha con accesorios
Bath and shower mixer with accessories

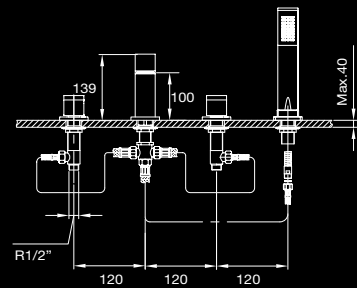
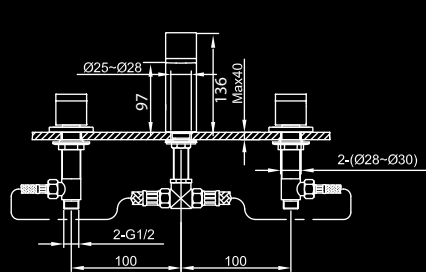

59 005 ●●●●●

Juego lavabo caño central
Wash basin in 3 holes mixer
Mélangeur 3 trous pour lavabo
Waschtischmischer dreilochbatterie
Смеситель для раковины на 3 отверстия

59 075 ●●●●●

Juego lavabo caño central válv. desag. click-clack
Wash basin in 3 holes mixer with click-clack waste
Batterie trois trous pour lavabo avec vidage click-clack
Waschtischmischer dreilochbatterie mit click-clack ablauf
Смеситель для раковины на 3 отверстия с клапаном клик-клак

59 714 ●●●●●

Grupo baño ducha 4 agujeros de repisa con ducha
Bath shower 4 holes mixer with handshower
Ensemble bain-douche 4 trous sur gorge avec ensemble de douche
Wannenrand bad und duschmischer
Смеситель на борт ванны для 4 отверстий с ручным душем



59 321 ●●●●●

Conjunto monomando empotrado de latón con duchita y flexo 1,25m
Cet single-lever concealed brass mixer with handspray and flexible hose 1.25 m
Ensemble mitigeur à encastrer laiton avec douchette et connexion flexible 1.25 m
Set messing unterputz-mischer mit handbrause und 1,25 m flexiblen schlauch
Встроенный смеситель с гигиеническим душем, шланг 1,25 м



59 016 ●●●●●

Llave de paso empotrar 1/2"
Built-in key step 1/2"
Robinet d'arrêt de 1/2"
Unterputz-ventil 1/2"
Кран встроенный 1/2"

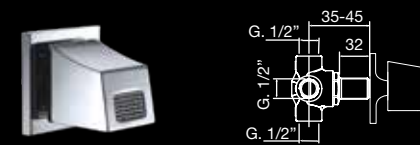

59 320 / 59 330 / 59 340 / 59 350 ●●●●●

Distribuidor empotrar 2/3/4/5 salidas
Built-in diverter 2/3/4/5 ways
Inverseur 2/3/4/5 voies à encastrer
2/3/4/5-wege-umsteller
Встроенный дивертер на 2/3/4/5 выхода

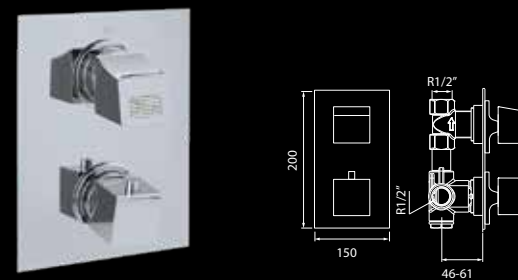

59 601 / 59 602 / 59 603 ●●●●●

Termostático baño ducha empotrar con inversor 1/2/3 vías
Thermostatic concealed bath shower with diverter 1/2/3 ways
Mitigeur thermostatique bain/douche à encastrer avec inverseur 1/2/3 vois
Thermostat für brause/wannenbatterie mit umstellung 1/2/3 abgängen
Термостатический смеситель встроенный душ и ванна на 1/2/3 выхода



SKIP DIAMOND ACCESSORIES
pag. 434

- CR
Cromo
Chrome
- O
Oro
Gold
- OR
Oro Rosa
Rose Gold
- OC
Oro cepillado
Brushed gold

MAIER



150

59 SkipDiamond



59 312 0
Monomando empotrar baño ducha
Built-in bath shower mixer

151

PRESTIGE

67 Muse Diamond



69 Chik Diamond



Swarovski® is a registered trademark of Swarovski AG



Swarovski® is a registered trademark of Swarovski AG

Muse Diamond

Chik Diamond



La fidelidad del diamante. Funcionalidad y elegancia minimalista convergen en este modelo enjoyado proporcionando un efecto teatral emocionante en la sala de baño. Dispone de cuatro decoraciones diferentes para un grifo irrepitible de diseño sublime.

La diva minimalista. La vistosa decoración Swarovski combinada con la excelencia de líneas esféricas. Una voz excepcional de refinado diseño que sobresale como solista en su etapa de baño.

The diamond loyalty. Functionality and minimalist elegance converge in this jeweled model providing an exciting theatrical effect to the bathroom. Four different decorations are available for an once-in-a-lifetime faucet of sublime design.

The minimalistic diva. The flamboyant Swarovski decoration meets the excellence of spherical lines. An exceptional voice of bespoke design that outstands as a soloist in your bathroom stage.

- CR**
Cromo
Chrome
Chrome
Chrom
Хром
- O**
Oro
Gold
Or
Gold
Золото
- OR**
Oro rosa
Rose gold
Or rosé
Rose Gold
Розовое золото



S STAGE CRYSTAL

R RING CRYSTAL

F FULL CRYSTAL

C CERALUN CRYSTAL



67 002S O



67 002R CR



67 002F OR



67 002C O



Muse Diamond

R RING CRYSTAL

67 002R 0
Monomando lavabo
Wash-basin mixer



Muse Diamond

C CERALUN CRYSTAL

67 002C 0
Monomando lavabo
Wash-basin mixer





Muse Diamond

S STAGE CRYSTAL

67 002S CR
Monomando lavabo
Wash-basin mixer



Chik Diamond

69 002 CR
Monomando lavabo
Wash-basin mixer



67 002 S / R / F / C
69 002

Monomando lavabo
Wash-basin mixer
Mitigeur lavabo
Einhebel waschtischmischer
Однорычажный Смеситель для раковины



67 102 S / R / F / C
69 102

Monomando lavabo alto
High wash-basin mixer
Mitigeur lavabo haut
Einhebel waschtischmischer. Hohemn ausführung
Однорычажный Смеситель для раковин высокий

67 004 S / R / F / C
69 004

Monomando lavabo válv. desag. click-clack
Wash-basin mixer with click-clack waste
Mitigeur lavabo avec vidage click-clack
Einhebel waschtischmischer click-clack ablauf
Однорычажный смеситель для раковины с донным клапаном

67 104 S / R / F / C
69 104

Monomando lavabo alto válv. desag. click-clack
High wash-basin mixer with click-clack waste
Mitigeur lavabo haut avec vidage click-clack
Einhebel waschtischmischer. Hohemn ausführung mit click-clack ablauf
Однорычажный смеситель для раковины высокий с клапаном клик-клак



67 009 S / R / F / C
69 009

Monomando bidé
Bidet mixer
Mitigeur bidet
Einhebel bidetmischer
Однорычажный смеситель для биде

67 011 S / R / F / C
69 011

Monomando bidé válv. desag. click-clack
Bidet mixer with click-clack waste
Mitigeur bidet avec vidage click-clack
Einhebel bidetmischer click-clack ablauf
Однорычажный смеситель для биде с клапаном клик-клак

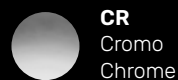

CR
Cromo
Chrome

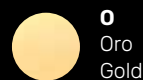

O
Oro
Gold

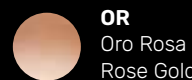

OR
Oro Rosa
Rose Gold



67 305 R

Bimando lavabo empotrado
Concealed 3 holes wash basin mixer
Mélangeur de lavabo 3 trous à encastrer
Unterputz 3-Loch Waschtischmischer
Встроенный смеситель для раковины на 3 отверстия

67 307 R

Bimando lavabo empotrado válv. desagüe click-clack
Concealed 3 holes wash basin mixer with click-clack waste
Mélangeur de lavabo 3 trous à encastrer avec vidage click-clack
Unterputz 3-Loch Waschtischmischer mit click-clack Ablaufgarnitur
Встроенный смеситель для раковины на 3 отверстия со сливом клик-клак



67 302 S / R / F / C
69 302

Monomando lavabo empotrado
Built-in single-lever wash-basin mixer
Mitigeur lavabo mural à encastrer
Unterputz Einhebel wannenmischer
Однорычажный смеситель для раковины настенный встроенный

67 304 S / R / F / C
69 304

Monomando lavabo empotrado valv. desag. click-clack
Built-in single-lever wash-basin with click-clack waste
Mitigeur lavabo mural à encastrer avec vidage click-clack
Unterputz Einhebel wannenmischer. Click-clack ablauf
Однорычажный смеситель для раковины настенный встроенный с коапаном клик-клак



MUSE DIAMOND ACCESSORIES
pag. 414

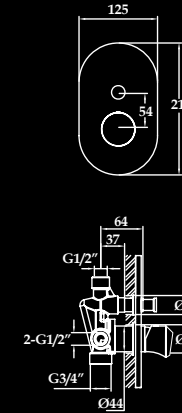

67 312 S / R / F / C ●●●●●
69 312 ●●●●●

Monomando empotrar baño ducha
Built-in bath shower mixer
Mitigeur bain-douche à encastrer
Unterputz wannen und duschmischer
Однорычажный Смеситель встроенный ванна душ

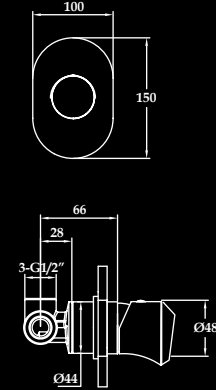

67 315 S / R / F / C ●●●●●
69 315 ●●●●●

Monomando empotrar ducha
Built-in shower mixer
Ensemble douche à encastrer
Unterputz duschmischer
Однорычажный Смеситель встроенный для душа

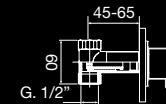
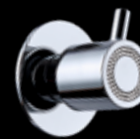

67 016 R ●●●●●

Llave de paso empotrar 1/2"
Built-in key step 1/2"
Robinet d'arrêt de 1/2"
Unterputz-ventil 1/2"
Кран встроенный 1/2"

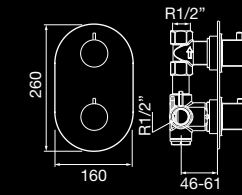

67 601 / 67 602 / 67 603 R ●●●●●

Termostático baño/ducha empotrar con inversor 1/2/3 vias
Thermostatic concealed bath & shower with diverter 1/2/3 ways
Mitigeur thermostatique bain/douche à encastrer avec inverseur 1/2/3 vois
Thermostat für brause/wannenbatterie mit umstellung 1/2/3 abgängen
Термостатический смеситель встроенный душ и ванна на 1/2/3 выхода

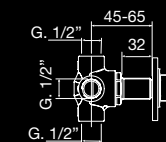
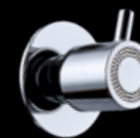

67 320 / 67 330 / 67 340 / 67 350 R ●●●●●

Distribuidor empotrar 2/3/4/5 salidas
Built-in diverter 2/3/4/5 ways
Inverseur 2/3/4/5 voies à encastrer
2/3/4/5-wege-umsteller
Встроенный дивертер на 2/3/4/5 выхода

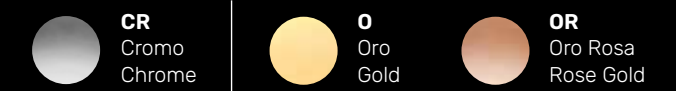

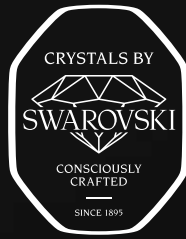

69 015 CR
Monomando ducha con accesorios
Shower mixer with accessories

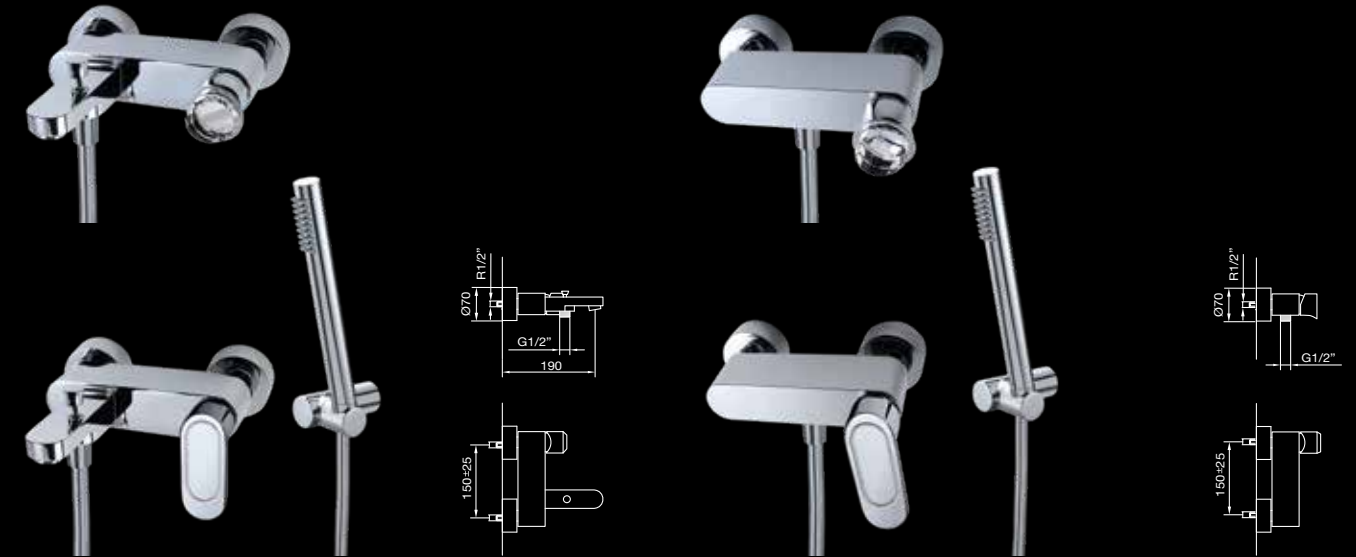

67 012 S / R / F / C ● ● ● ● ●
69 012 ● ● ● ● ●

Monomando baño ducha con accesorios
Bath and shower mixer with accessories
Mitigeur bain-douche avec accessoires
Einhebel wannen und duschmischer
Смеситель ванна / душ настенного монтажа с аксессуарами

67 015 S / R / F / C ● ● ● ● ●
69 015 ● ● ● ● ●

Monomando ducha con accesorios
Shower mixer with accessories
Mitigeur douche avec ensemble de douche
Einhebel duschmischer
Смеситель для душа настенного монтажа с аксессуарами

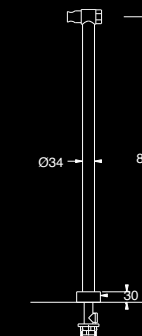

67 512 S / R / F / C ● ● ● ● ●
69 512 ● ● ● ● ●

Grupo baño ducha con columnas suelo de 820 mm
Bath shower group with floor-standing columns of 820 mm
Mitigeur bain-douche sur colonnes de 820 mm
Wannen batterie mit 820 mm hohen boden anschluss, handbrause und flexiblen schlauch
Смеситель ванна / душ с напольными колоннами 820 мм



65 Concrete



CONCRETE



Pomos / Handles



LS
Liso
Plain

FL
Flor
Flower

Acabados / Finishes



CN
Hormigón
Concrete

BL
Blanco
White

AZ
Azul
Blue

RS
Rosa
Rose

MR
Marrón
Brown

CR
Cromo
Chrome
Chrome
Хром

NG
Negro mate
Matt black
Noir mate
Schwarz matte
Черное

NI
Níquel mate
Matt nickel
Matt nickel
Matt Nickel
матовый никел

GCP
Grafito Cepillado PVD
Brushed Gun Metal PVD
Graphite Brossé PVD
Gebürstetes Gun Metal PVD
матовый металл PVD



65 005 J NI LS AZ
Juego lavabo caño central
Wash basin in 3 holes mixer



65 305 NG FL BL
Bimando lavabo empotrado
Concealed 3 holes wash basin mixer



65 005 J NG FL RS
Juego lavabo caño central
Wash basin in 3 holes mixer



65 005J ●●●●●

Grupo baño ducha 4 agujeros de repisa con ducha
Bath shower 4 holes mixer with handshower
Ensemble bain-douche 4 trous sur gorge avec ensemble de douche
Wannenrand bad und duschmischer
Смеситель на борт ванны для 4 отверстий с ручным душем

65 075J ●●●●●

Juego lavabo caño central válv. desag. click-clack
Wash basin in 3 holes mixer with click-clack waste
Mélangeur 3 trous pour lavabo avec vidage click-clack
Waschtischmischer dreilochbatterie mit click-clack ablauf
Смеситель для раковины на 3 отверстия с клапаном клик-клак

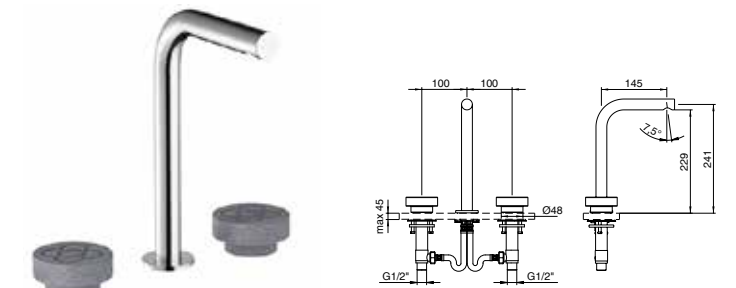

65 005L ●●●●●

Juego lavabo caño central
Wash basin in 3 holes mixer
Mélangeur 3 trous pour lavabo
Waschtischmischer dreilochbatterie
Смеситель для раковины на 3 отверстия

65 075L ●●●●●

Juego lavabo caño central válv. desag. click-clack
Wash basin in 3 holes mixer with click-clack waste
Mélangeur 3 trous pour lavabo avec vidage click-clack
Waschtischmischer dreilochbatterie mit click-clack ablauf
Смеситель для раковины на 3 отверстия с клапаном клик-клак

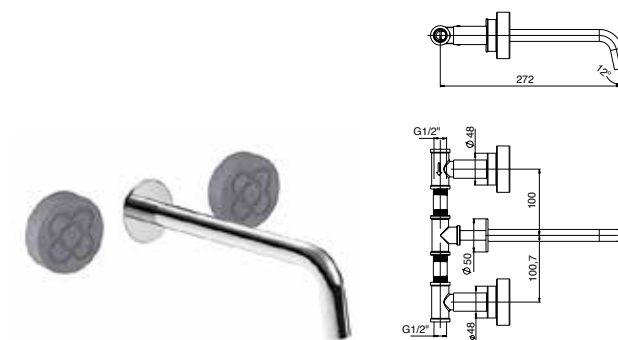

65 305 ●●●●●

Bimando lavabo empotrado
Concealed 3 holes wash basin mixer
Mélangeur de lavabo 3 trous à encastrer
Unterputz 3-Loch Waschtischmischer
Встроенный смеситель для раковины на 3 отверстия

65 307 ●●●●●

Bimando lavabo empotrado válvula desagüe click-clack
Concealed 3 holes wash basin mixer with click-clack waste
Mélangeur de lavabo 3 trous à encastrer avec vidage click-clack
Unterputz 3-Loch Waschtischmischer mit Click-Clack Ablaufgarnitur
Встроенный смеситель для раковины на 3 отверстия со сливом клик-клак



65 714J ●●●●●

Grupo baño ducha 4 agujeros de repisa con ducha
Bath shower 4 holes mixer with handshower
Ensemble bain-douche 4 trous sur gorge avec ensemble de douche
Wannenrand bad und duschmischer
Смеситель на борт ванны для 4 отверстий с ручным душем

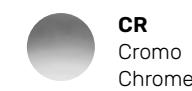

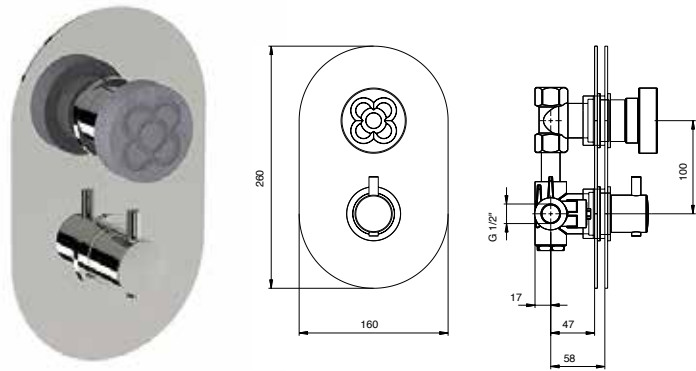

65 601 / 65 602 / 65 603 ●●●●●

Termostático baño ducha empotrar con inversor 1/2/3 vías
 Thermostatic concealed bath shower with diverter 1/2/3 ways
 Mitigeur thermostatique bain/douche à encastrer avec inverseur 1/2/3 voies
 Thermostat für brause/wannenbatterie mit umstellung 1/2/3 abgängen
 Термостатический смеситель встроенный душ и ванна на 1/2/3 выхода

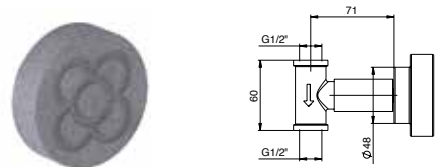

65 016 ●●●●●

Llave de paso empotrar 1/2"
 Built-in key step 1/2"
 Robinet d'arrêt de 1/2"
 Unterputz-ventil 1/2"
 Кран встроенный 1/2"

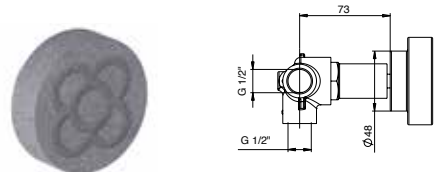

65 320 / 65 330 / 65 340 / 65 350 ●●●●●

Distribuidor empotrar 2/3/4/5 salidas
 Built-in diverter 2/3/4/5 ways
 Inverseur 2/3/4/5 voies à encastrer
 2/3/4/5-wege-umsteller
 Встроенный дивертер на 2/3/4 /5 выхода



65 512 ●●●●●

Grifo exento baño ducha 820 mm con accesorios
 Floorstanding bath shower mixer 820 mm with accessories
 Mélangeur colonne bain-douche 820 mm avec accessoires
 Wannen batterie mit 820 mm hohen boden anschluss, handbrause
 und flexiblen schlauch
 Смеситель ванна / душ с напольными колоннами 820 mm

- **CR**
Cromo
Chrome
- **NG**
Negro mate
Matt black
- **NI**
Níquel mate
Matt nickel
- **GCP**
Grafito Cepillado PVD
Brushed Gun Metal PVD



MAIER

65 Concrete

CONTEMPORARY



81 Disk



Disk



La belleza de la tranquilidad. Una colección que domestica desiertos y mares y los hace confluir a través del trabajo metódico de las líneas. Sus superficies sutilmente magnéticas llenarán de vida cualquier rincón del baño y añadirán nuevos horizontes al espacio.

The beauty of tranquillity. A collection that tames deserts and seas and brings them together through the meticulous work of lines. Its subtly magnetic surfaces will fill any corner of the bathroom with life and will add new horizons to the space.

Pomos / Handles



- L**
Liso
Plain
- P**
Puntos
Dots
- R**
Rayas
Stripes
- C**
Curvo
Curved

- CR**
Cromo
Chrome
Chrom
Хром
- O**
Oro
Gold
Or
Gold
Золото
- OC**
Oro cepillado
Brushed gold
Or brossé
Gebürstetes gold
Брашированное золото



81 005J O C
Juego lavabo caño central
Wash basin in 3 holes mixer

MAIER



81 005L OC L
Juego lavabo caño central
Wash basin in 3 holes mixer

81 Disk



81 305 CR P
Bimando lavabo empotrado
Concealed 3 holes wash basin mixer

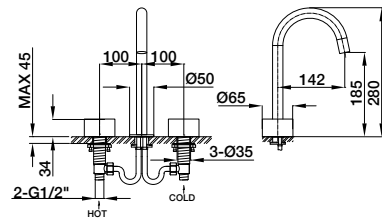

81 005J ● ● ●

Juego lavabo caño central
Wash basin in 3 holes mixer
Mélangeur 3 trous pour lavabo
Waschtischmischer dreilochbatterie
Смеситель для раковины на 3 отверстия

81 075J ● ● ●

Juego lavabo caño central válv. desag. click-clack
Wash basin in 3 holes mixer with click-clack waste
Mélangeur 3 trous pour lavabo avec vidage click-clack
Waschtischmischer dreilochbatterie mit click-clack ablauf
Смеситель для раковины на 3 отверстия с клапаном клик-клак

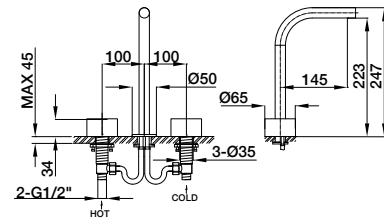

81 005L ● ● ●

Juego lavabo caño central
Wash basin in 3 holes mixer
Mélangeur 3 trous pour lavabo
Waschtischmischer dreilochbatterie
Смеситель для раковины на 3 отверстия

81 075L ● ● ●

Juego lavabo caño central válv. desag. click-clack
Wash basin in 3 holes mixer with click-clack waste
Mélangeur 3 trous pour lavabo avec vidage click-clack
Waschtischmischer dreilochbatterie mit click-clack ablauf
Смеситель для раковины на 3 отверстия с клапаном клик-клак

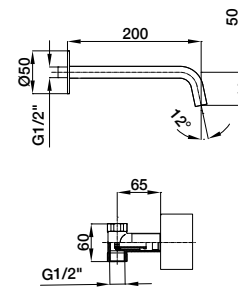

81 305 ● ● ●

Bimando lavabo empotrado
Concealed 3 holes wash basin mixer
Mélangeur de lavabo 3 trous à encastrer
Unterputz 3-Loch Waschtischmischer
Встроенный смеситель для раковины на 3 отверстия

81 307 ● ● ●

Bimando lavabo empotrado válvula desagüe click-clack
Concealed 3 holes wash basin mixer with click-clack waste
Mélangeur de lavabo 3 trous à encastrer avec vidage click-clack
Unterputz 3-Loch Waschtischmischer mit Click-Clack Ablaufgarnitur
Встроенный смеситель для раковины на 3 отверстия со сливом клик-клак

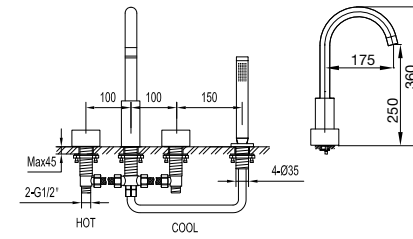

81 714J ● ● ●

Grupo baño ducha 4 agujeros de repisa con ducha
Bath shower 4 holes mixer with handshower
Ensemble bain-douche 4 trous sur gorge avec ensemble de douche
Wannenrand bad und duschmischer
Смеситель на борт ванны для 4 отверстий с ручным душем

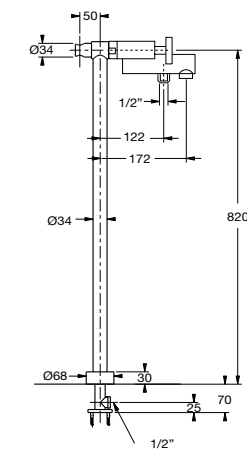
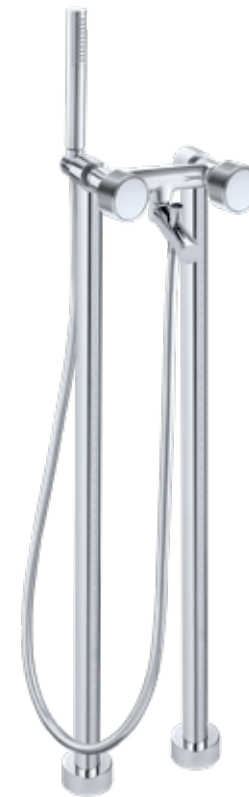

81 512 ● ● ●

Grupo baño ducha con columna suelo de 820 mm
Bath shower group with floor-standing column of 820 mm
Mélangeur bain-douche sur colonne de 820 mm
Wannen batterie mit 820 mm hohen boden anschluss,
Handbrause und flexiblen schlauch
Смеситель ванна / душ с напольными колоннами 820 mm

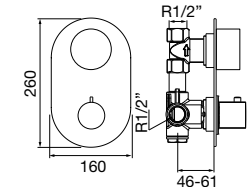
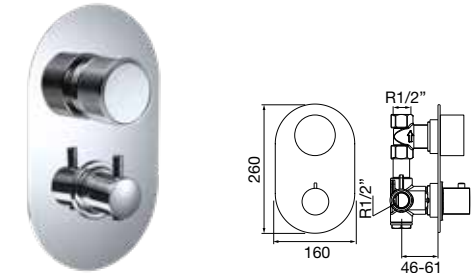

81 601 / 81 602 / 81 603 ● ● ●

Termostático baño ducha empotrar con inversor 1/ 2/ 3 vías
Thermostatic concealed bath shower with diverter 1/ 2/ 3 ways
Mitigeur thermostatique bain/douche à encastrer avec inverseur 1/ 2/ 3 vois
Thermostat für brause/wannenbatterie mit umstellung 1/ 2/ 3 abgängen
Термостатический смеситель встроенный душ и ванна на 1/ 2/ 3 выхода

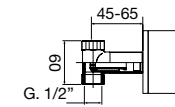

81 016 ● ● ●

Llave de paso empotrar 1/2"
Built-in key step 1/2"
Robinet d'arrêt de 1/2"
Unterputz-ventil 1/2"
Кран встроенный 1/2"

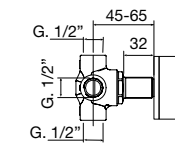

81 320 / 81 330 / 81 340 / 81 350 ● ● ●

Distribuidor empotrar 2/3/4/5 salidas
Built-in diverter 2/3/4/5 ways
Inverseur 2/3/4/5 voies à encastrer
2/3/4/5-wege-umsteller
Встроенный дивертер на 2/3/4 /5 выхода



76 Bloom







Bloom



La eterna primavera. El latido alegre y grácil de las flores immortalizado en un grifo que derrama movimiento al más puro estilo neoclásico. El vigor de sus expresivas formas naturales confiere a este diseño la capacidad de conectar la razón con la emoción.

Eternal Spring. The joyful and graceful heartbeat of the flowers immortalized in a faucet that spills movement in the purest neoclassical style. The vigor of the expressive natural forms gives this design the ability to connect reason with emotion.

- | | | | | | | | |
|---|---|---|---|---|--|---|---|
|  | CR
Cromo
Chrome
Chrome
Chrom
Хром |  | O
Oro
Gold
Or
Gold
Золото |  | OR
Oro rosa
Rose gold
Or rosé
Rose Gold
Розовое золото |  | OC
Oro cepillado
Brushed gold
Or brossé
Gebürstetes gold
Брашированное золото |
|---|---|---|---|---|--|---|---|



76 005J OR
Juego lavabo caño central
Wash basin in 3 holes mixer

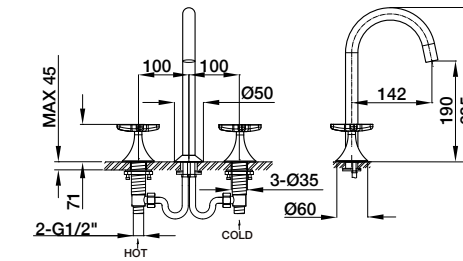

76 005J ●●●●

Juego lavabo caño central
Wash basin in 3 holes mixer
Mélangeur 3 trous pour lavabo
Waschtischmischer dreilochbatterie
Смеситель для раковины на 3 отверстия

76 075J ●●●●

Juego lavabo caño central válv. desag. click-clack
Wash basin in 3 holes mixer with click-clack waste
Mélangeur 3 trous pour lavabo avec vidage click-clack
Waschtischmischer dreilochbatterie mit click-clack ablauf
Смеситель для раковины на 3 отверстия с клапаном клик-клак

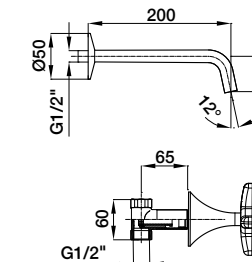

76 305 ●●●●

Bimando lavabo empotrado
Concealed 3-hole wash basin mixer
Mélangeur de lavabo 3 trous à encastrer
Unterputz 3-Loch Waschtischmischer
Встроенный смеситель для раковины на 3 отверстия

76 307 ●●●●

Bimando lavabo empotrado válvula desagüe click-clack
Concealed 3-hole wash basin mixer with click-clack waste
Mélangeur de lavabo 3 trous à encastrer avec vidage click-clack
Unterputz 3-Loch Waschtischmischer mit Click-Clack Ablaufgarnitur
Встроенный смеситель для раковины на 3 отверстия со сливом клик-клак





76 714J ●●●●●

Grupo baño ducha 4 agujeros de repisa con ducha
 Bath shower 4 holes mixer with handshower
 Ensemble bain-douche 4 trous sur gorge avec ensemble de douche
 Wannenrand bad und duschmischer
 Смеситель на борт ванны для 4 отверстий с ручным душем

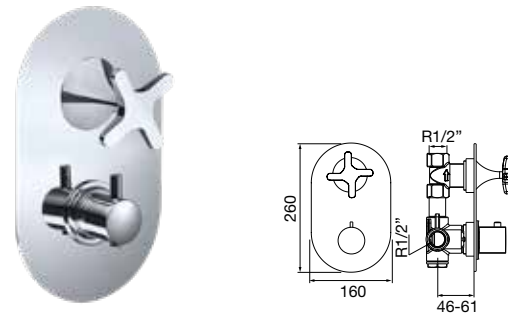

76 601 / 76 602 / 76 603 ●●●●●

Termostático baño ducha empotrar con inversor 1/ 2/ 3 vías
 Thermostatic concealed bath / shower with diverter 1/ 2/ 3 ways
 Mitigeur thermostatique bain/douche à encastrer avec inverseur 1/ 2/ 3 voies
 Thermostat für brause/wannenbatterie mit umstellung 1/ 2/ 3 abgängen
 Термостатический смеситель встроенный / душ и ванна / на 1/ 2/ 3 выхода



76 016 ●●●●●

Llave de paso empotrar 1/2"
 Built-in key step 1/2"
 Robinet d'arrêt de 1/2"
 Unterputz-ventil 1/2"
 Кран встроенный 1/2"

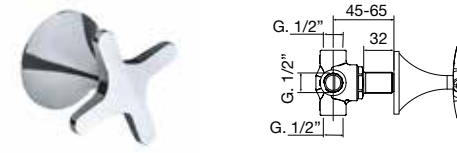

76 320 / 76 330 / 76 340 / 76 350 ●●●●●

Distribuidor empotrar 2/3/4/5 salidas
 Built-in diverter 2/3/4/5 ways
 Inverseur 2/3/4/5 voies à encastrer
 2/3/4/5-wege-umsteller
 Встроенный дивертер на 2/3/4 /5 выхода

- CR**
Cromo
Chrome
- O**
Oro
Gold
- OR**
Oro Rosa
Rose Gold
- OC**
Oro cepillado
Brushed gold

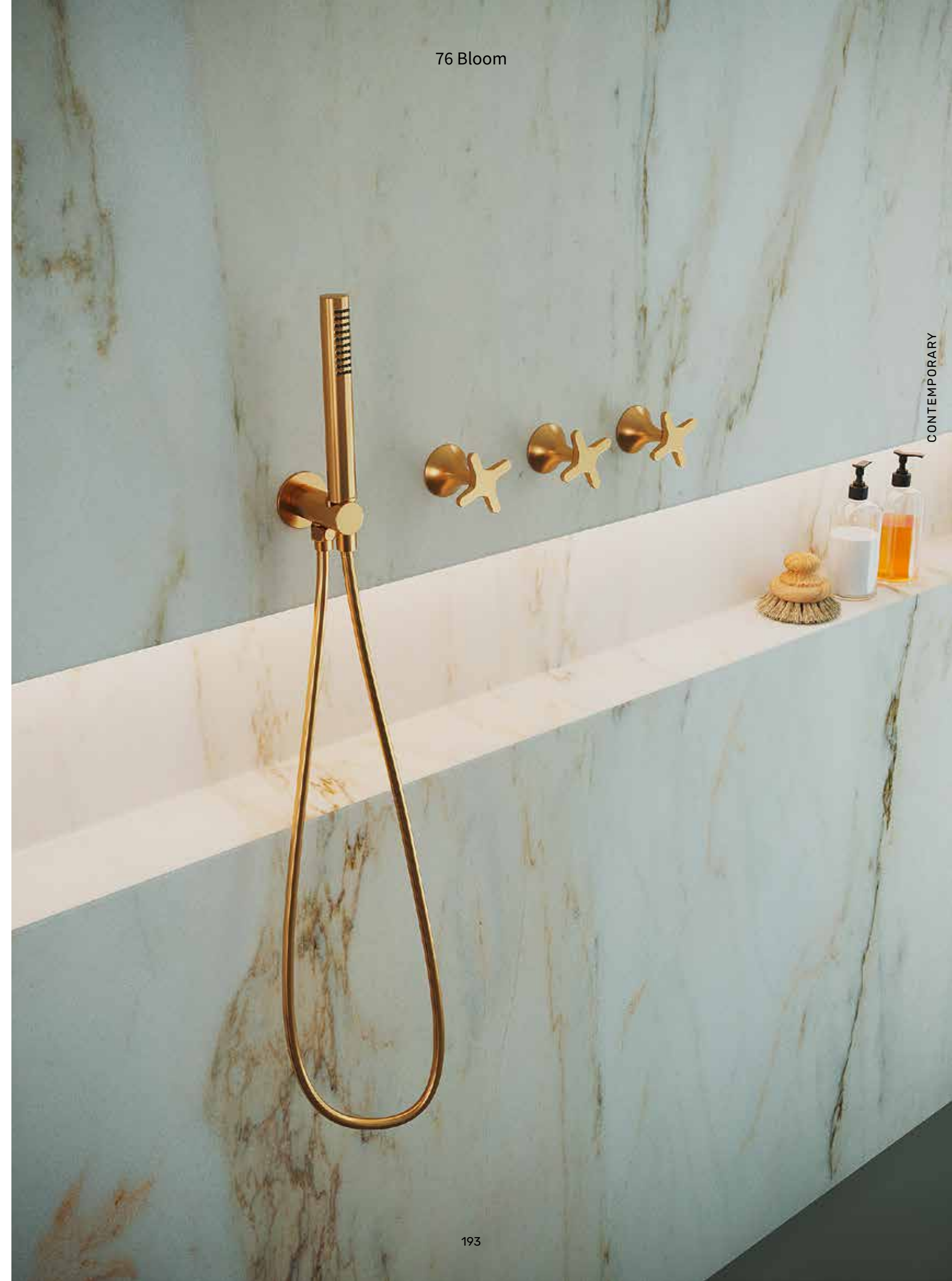

74 Ikon



Ikon



Las mil caras del agua. Una colección que redefine el lujo y revoluciona la física con sus líneas geométricas imposibles. Ha nacido un grifo innovador e icónico, el agua fluyendo es ahora un prisma de infinitas caras.

Thousand facets of water. A collection that redefines luxury and shake up physics with its impossible geometric lines. An innovative faucet icon is born, flowing water is now a prism with endless faces.



CR
Cromo
Chrome
Chrome
Chrom
Хром



NG
Negro mate
Matt black
Noir mate
Schwarz matte
Черное



CO
Cobre mate
Matt copper
Cuivre mat
Kupfer matt
Матовая медь



O
Oro
Gold
Or
Gold
Золото



OR
Oro rosa
Rose gold
Or rosé
Rose Gold
Розовое золото



OC
Oro cepillado
Brushed gold
Or brossé
Gebürstetes gold
Брашированное золото



74 002 NG / 74 002 BL
Monomando lavabo
Wash-basin mixer



MAIER



CR
Cromo
Chrome



NG
Negro mate
Matt black



CO
Cobre mate
Matt copper

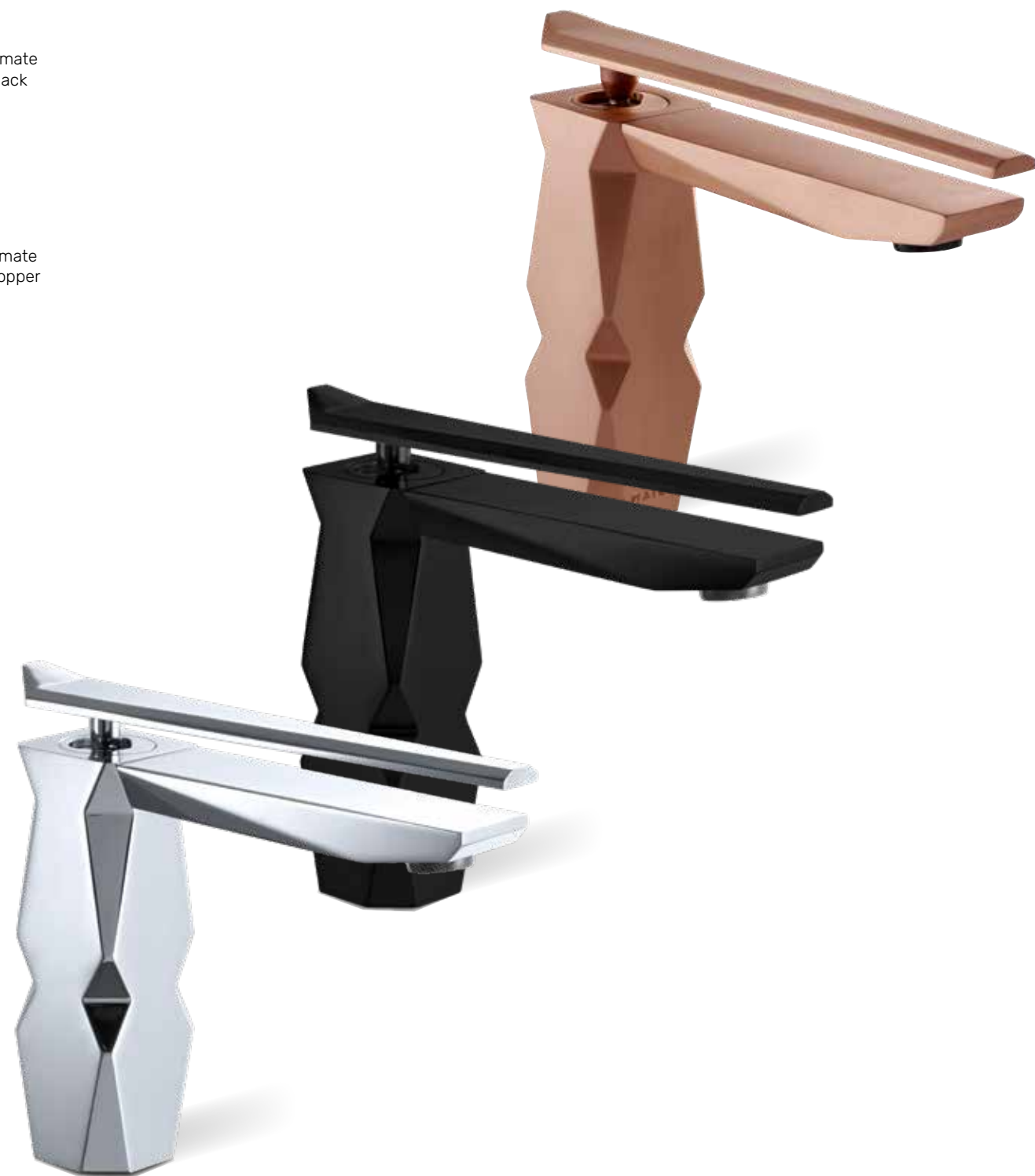

74 Ikon



O
Oro
Gold



OR
Oro rosa
Rose gold



OC
Oro cepillado
Brushed gold



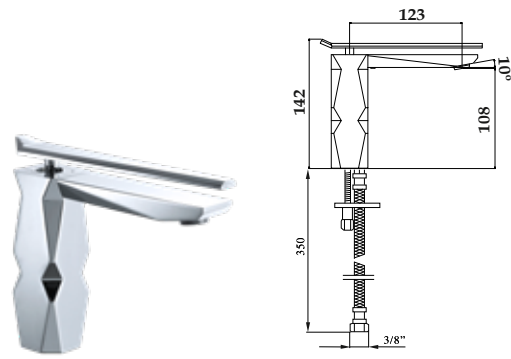

74 002 ●●●●●●

Monomando lavabo
Wash-basin mixer
Mitigeur lavabo
Einhebel waschtischmischer
Однорычажный Смеситель для раковины

74 004 ●●●●●●

Monomando lavabo válv. desag. click-clack
Wash-basin mixer with click-clack waste
Mitigeur lavabo avec vidage click-clack
Einhebel waschtischmischer click-clack ablauf
Однорычажный смеситель для раковины с клапаном клик-клак

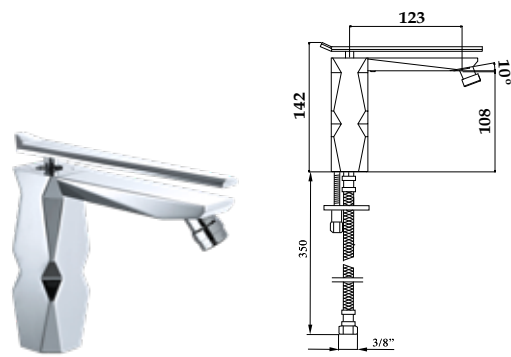

74 009 ●●●●●●

Monomando bidé
Bidet mixer
Mitigeur bidet
Einhebel bidetmischer
Однорычажный смеситель для биде

74 011 ●●●●●●

Monomando bidé válv. desag. click-clack
Bidet mixer with click-clack waste
Mitigeur bidet avec vidage click-clack
Einhebel bidetmischer click-clack ablauf
Однорычажный смеситель для биде с клапаном клик-клак

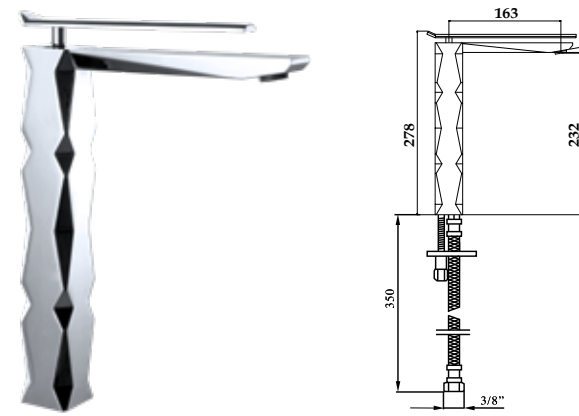

74 102 ●●●●●●

Monomando lavabo alto
High wash-basin mixer
Mitigeur lavabo haut
Einhebel waschtischmischer. Hohemn ausführung
Однорычажный Смеситель для раковин высокий

74 104 ●●●●●●

Monomando lavabo alto válv. desag. click-clack
High wash-basin mixer with click-clack waste
Mitigeur lavabo haut avec vidage click-clack
Einhebel waschtischmischer. hohemn ausführung mit click-clack ablauf
Однорычажный смеситель для раковины высокий с клапаном клик-клак

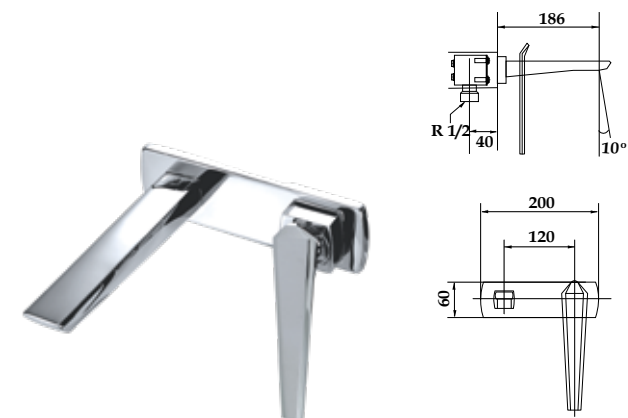

74 302 ●●●●●●

Monomando lavabo empotrado
Built-in single-lever wash-basin mixer
Mitigeur lavabo mural à encastrer
Unterputz Einhebel wannenmischer
Однорычажный смеситель для раковины настенный встроенный

74 304 ●●●●●●

Monomando lavabo empotrado válv. desag. click-clack
Built-in single-lever wash-basin with click-clack waste
Mitigeur lavabo mural à encastrer avec vidage click-clack
Unterputz Einhebel wannenmischer. click-clack ablauf
Встроенный с клапаном клик-клак

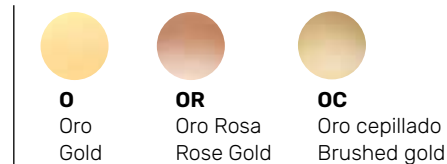

74 102 CO
Monomando lavabo alto
High wash-basin mixer



74 012 OR
Monomando baño ducha con accesorios
Bath and shower mixer with accessories

74 Ikon

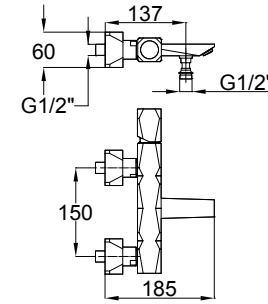

74 012 ●●●●●●●●

Monomando baño ducha con accesorios
Bath and shower mixer with accessories
Mitigeur bain-douche avec accessoires
Einhebel wannen und duschmischer
Смеситель ванна / душ настенного монтажа с аксессуарами

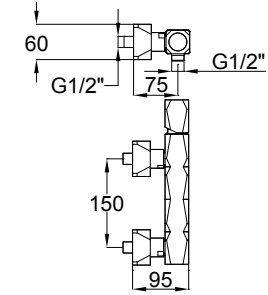

74 015 ●●●●●●●●

Monomando ducha con accesorios
Shower mixer with accessories
Mitigeur douche avec ensemble de douche
Einhebel duschmischer
Смеситель для душа настенного монтажа с аксессуарами

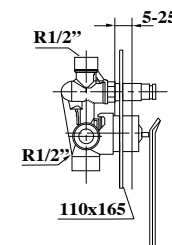
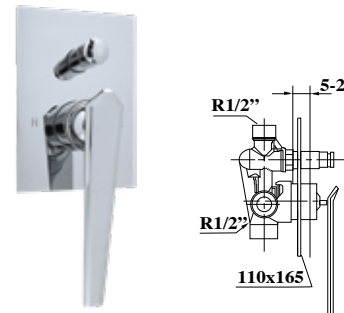

74 312 ●●●●●●●●

Monomando empotrar baño ducha
Built-in bath shower mixer
Mitigeur bain-douche à encastrer
Unterputz wannen und duschmischer
Однорычажный Смеситель встроенный ванна душ

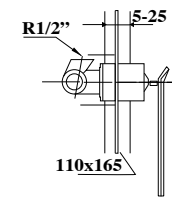
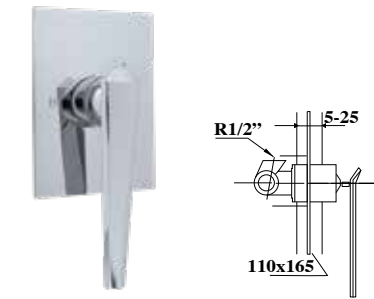

74 315 ●●●●●●●●

Monomando empotrar ducha
Built-in shower mixer
Ensemble douche à encastrer
Unterputz duschmischer
Однорычажный Смеситель встроенный для душа



CR
Cromo
Chrome



NG
Negro mate
Matt black



CO
Cobre mate
Matt copper



O
Oro
Gold



OR
Oro Rosa
Rose Gold



OC
Oro cepillado
Brushed gold

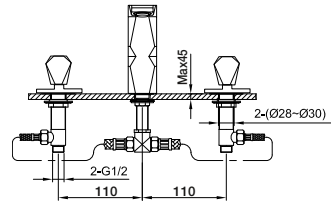

74 005 ●●●●●●●●

Juego lavabo caño central
Wash basin in 3 holes mixer
Mélangeur 3 trous pour lavabo
Waschtischmischer dreilochbatterie
Смеситель для раковины на 3 отверстия

74 075 ●●●●●●●●

Juego lavabo caño central válv. desag. click-clack
Wash basin in 3 holes mixer with click-clack waste
Batterie trois trous pour lavabo avec vidage click-clack
Waschtischmischer dreilochbatterie mit click-clack ablauf
Смеситель для раковины на 3 отверстия с клапаном клик-клак

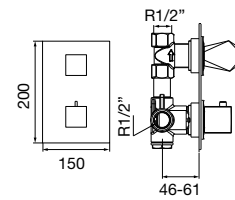

74 601 / 74 602 / 74 603 ●●●●●●●●

Termostático baño ducha empotrar con inversor 1/2/3 vías
Thermostatic concealed bath shower with diverter 1/2/3 ways
Mitigeur thermostatique bain/douche à encastrer avec inverseur 1/2/3 voies
Thermostat für brause/wannenbatterie mit umstellung 1/2/3 abgängen
Термостатический смеситель встроенный душ и ванна на 1/2/3 выхода



74 718 ●●●●●●●●

Grupo baño ducha 5 agujeros de repisa con ducha
Bath shower 5 holes mixer with handshower
Ensemble bain-douche 5 trous sur gorge avec ensemble de douche
Wannenrand bad und duschmischer
Смеситель на борт ванны для 5 отверстий с ручным душем

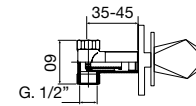
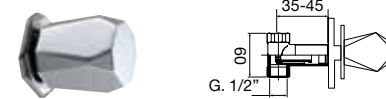

74 016 ●●●●●●●●

Llave de paso empotrar 1/2"
Built-in key step 1/2"
Robinet d'arrêt de 1/2"
Unterputz-ventil 1/2"
Кран встроенный 1/2"

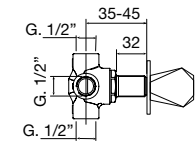
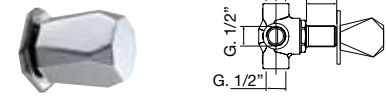

74 320 / 74 330 / 74 340 / 74 350 ●●●●●●●●

Distribuidor empotrar 2/3/4/5 salidas
Built-in diverter 2/3/4/5 ways
Inverseur 2/3/4/5 voies à encastrer
2/3/4/5-Wege-umsteller
Встроенный дивертер на 2/3/4/5 выхода





CONTEMPORARY

IKON ACCESSORIES
pag. 408



74 002 O/CR/OR/GF
Monomando lavabo
Wash-basin mixer



45/46 Skulpture

Skulpture



El arte de la piedra. Una colección orgánica coronada por una pieza de mármol pulido que traslada el baño a plena naturaleza. En blanco, mármol de Carrara, en negro, mármol Marquina y customizable en otras variedades de la piedra más escultórica del planeta.

The art of stone. An organic collection crowned by a piece of polished marble that moves the bathroom to full nature. In white, made with Carrara marble, in black, made with Marquina marble and customizable in other varieties of the most sculptural stone on the planet.

- CR**
 Cromo
 Chrome
 Chrom
 Хром
- O**
 Oro
 Gold
 Or
 Gold
 Золото
- OC**
 Oro cepillado
 Brushed gold
 Or brossé
 Gebürstetes gold
 Брашированное золото



- AS**
Amarillo
Siena
- CA**
Carrara
- MK**
Markina
- OA**
Ónix
Ágatha
- OV**
Ónix
Verde
- PT**
Portoro
- RV**
Rosa
Valencia
- VI**
Verde
India

Disponibles / Available: **MK - CA** Bajo solicitud / Under request: **All Others**

MAIER

45/46 Skulpture

CONTEMPORARY

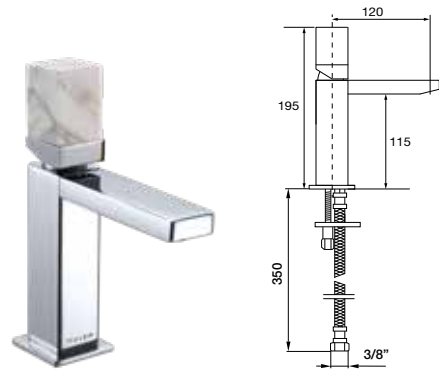

45 002 ●●●●

Monomando lavabo
Wash-basin mixer
Mitigeur lavabo
Einhebel waschtischmischer
Однорычажный Смеситель для раковины

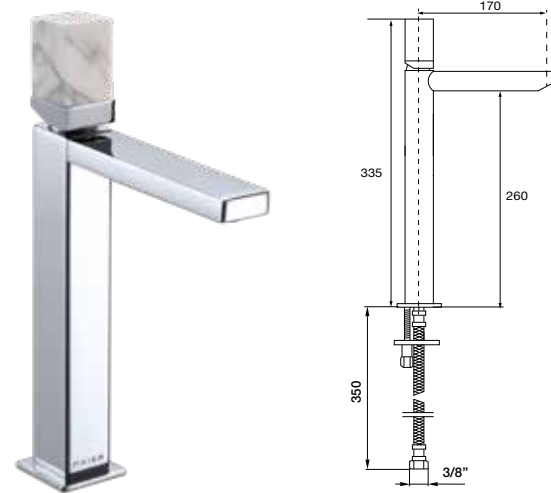

45 102 ●●●●

Monomando lavabo alto
High wash-basin mixer
Mitigeur lavabo haut
Einhebel waschtischmischer. Hohemn ausführung
Однорычажный Смеситель для раковин высокий



45 012 ●●●●

Monomando baño ducha con accesorios
Bath and shower mixer with accessories
Mitigeur bain-douche avec accessoires
Einhebel wannen und duschmischer
Смеситель ванна / душ настенного монтажа с аксессуарами



45 015 ●●●●

Monomando ducha con accesorios
Shower mixer with accessories
Mitigeur douche avec ensemble de douche
Einhebel duschmischer
Смеситель для душа настенного монтажа с аксессуарами

45 004 ●●●●

Monomando lavabo válv. desag. click-clack
Wash-basin mixer with click-clack waste
Mitigeur lavabo avec vidage click-clack
Einhebel waschtischmischer click-clack ablauf
Однорычажный смеситель для раковины с клапаном клик-клак

45 104 ●●●●

Monomando lavabo alto válv. desag. click-clack
High wash-basin mixer with click-clack waste
Mitigeur lavabo haut avec vidage click-clack
Einhebel waschtischmischer. Hohemn ausführung mit click-clack ablauf
Однорычажный смеситель для раковины высокий с клапаном клик-клак

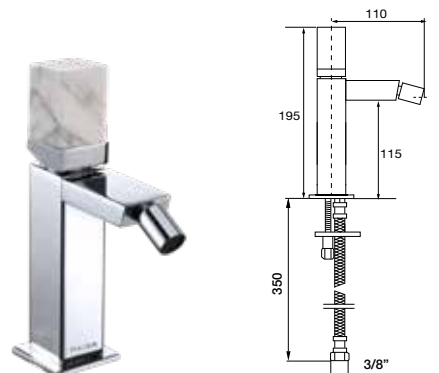

45 009 ●●●●

Monomando bidé
Bidet mixer
Mitigeur bidet
Einhebel bidetmischer
Однорычажный смеситель для биде

45 011 ●●●●

Monomando bidé válv. desag. click-clack
Bidet mixer with click-clack waste
Mitigeur bidet avec vidage click-clack
Einhebel bidetmischer click-clack ablauf
Однорычажный смеситель для биде с клапаном клик-клак

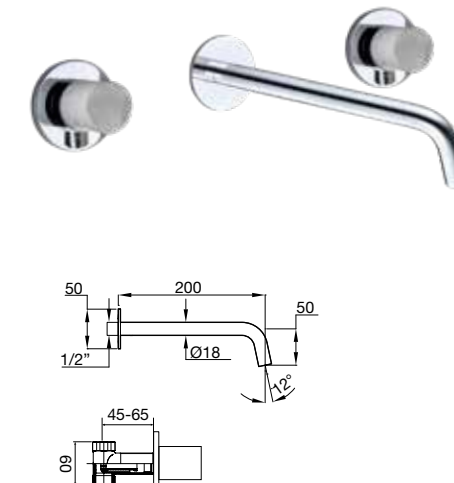

46 305 ●●●●

Bimando lavabo empotrado
Concealed 3 holes wash basin mixer
Mélangeur de lavabo 3 trous à encastrer
Unterputz 3-Loch Waschtischmischer
Встроенный смеситель для раковины на 3 отверстия

46 307 ●●●●

Bimando lavabo empotrado válv. desag. click-clack
Concealed 3 holes wash basin mixer with click-clack waste
Mélangeur de lavabo 3 trous à encastrer avec vidage click-clack
Unterputz 3-Loch Waschtischmischer mit click-clack Ablaufgarnitur
Встроенный смеситель для раковины на 3 отверстия со сливом клик-клак

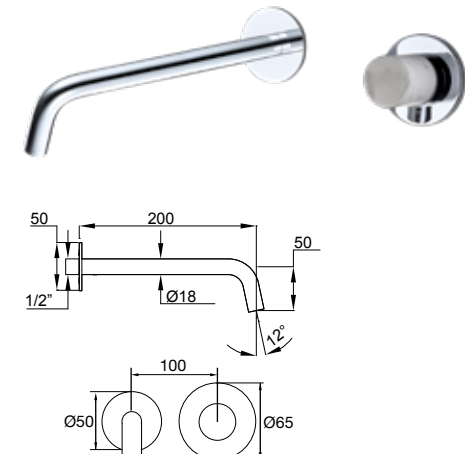

46 302 ●●●●

Monomando lavabo empotrado
Built-in single-lever wash-basin mixer
Mitigeur lavabo mural à encastrer
Unterputz Einhebel wannenmischer
Однорычажный смеситель для раковины настенный встроенный

46 304 ●●●●

Monomando lavabo empotrado válv. desag. click-clack
Built-in single-lever wash-basin with click-clack waste
Mitigeur lavabo mural à encastrer avec vidage click-clack
Unterputz Einhebel wannenmischer. click-clack ablauf
Однорычажный смеситель для раковины настенный встроенный с копаном клик-клак

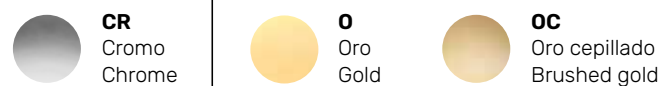

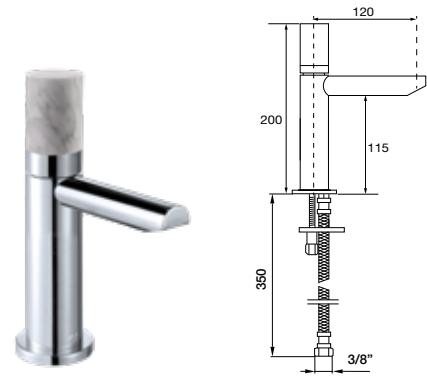

46 002 ●●●

Monomando lavabo
Wash-basin mixer
Mitigeur lavabo
Einhebel waschtischmischer
Однорычажный Смеситель для раковины

46 004 ●●●

Monomando lavabo válv. desag. click-clack
Wash-basin mixer with click-clack waste
Mitigeur lavabo avec vidage click-clack
Einhebel waschtischmischer click-clack ablauf
Однорычажный смеситель для раковины с клапаном клик-клак

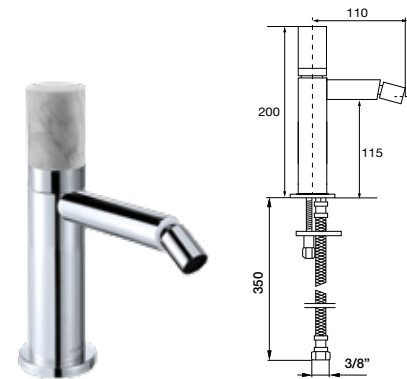

46 009 ●●●

Monomando bidé
Bidet mixer
Mitigeur bidet
Einhebel bidetmischer
Однорычажный смеситель для биде

46 011 ●●●

Monomando bidé válv. desag. click-clack
Bidet mixer with click-clack waste
Mitigeur bidet avec vidage click-clack
Einhebel bidetmischer click-clack ablauf
Однорычажный смеситель для биде с клапаном клик-клак

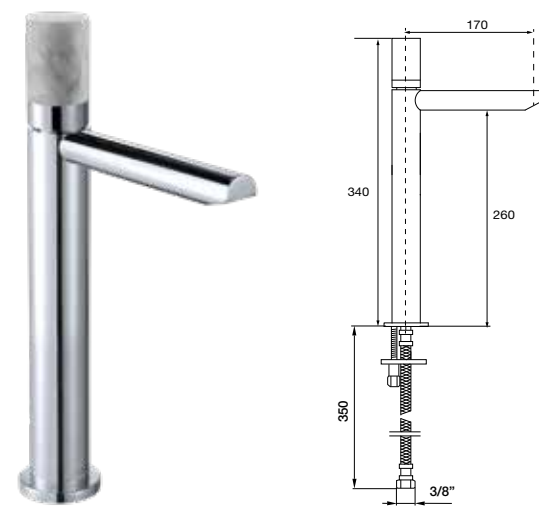

46 102 ●●●

Monomando lavabo alto
High wash-basin mixer
Mitigeur lavabo haut
Einhebel waschtischmischer. Hohemn ausführung
Однорычажный Смеситель для раковин высокий

46 104 ●●●

Monomando lavabo alto válv. desag. click-clack
High wash-basin mixer with click-clack waste
Mitigeur lavabo haut avec vidage click-clack
Einhebel waschtischmischer. Hohemn ausführung mit click-clack ablauf
Однорычажный смеситель для раковины высокий с клапаном клик-клак



46 702 ●●●

Monomando lavabo repisa
Deck mounted single-lever wash basin mixer
Mitigeur de lavabo 2 trous sur gorge
Einhand Waschtischmischer 2-Loch
Однорычажный смеситель на столешницу / раковину

46 704 ●●●

Monomando lavabo repisa válv. desag. click-clack
Deck mounted single-lever wash basin mixer with click-clack waste
Mitigeur de lavabo 2 trous sur gorge avec vidage click-clack
Einhand Waschtischmischer mit click-clack Ablaufgarnitur
Однорычажный смеситель на столешницу / раковину со сливом клик-клак



45 002 O CA 46 002 CR CA
Monomando lavabo
Wash-basin mixer



46 005J ●●●●
 Juego lavabo caño central
 Wash basin in 3 holes mixer
 Mélangeur 3 trous pour lavabo
 Waschtischmischer dreilochbatterie
 Смеситель для раковины на 3 отверстия

46 075J ●●●●
 Juego lavabo caño central válv. desag. click-clack
 Wash basin in 3 holes mixer with click-clack waste
 Batterie trois trous pour lavabo avec vidage click-clack
 Waschtischmischer dreilochbatterie mit click-clack ablauf
 Смеситель для раковины на 3 отверстия с клапаном клик-кляк



46 016 ●●●●
 Llave de paso empotrar 1/2"
 Built-in key step 1/2"
 Robinet d'arrêt de 1/2"
 Unterputz-ventil 1/2"
 Кран встроенный 1/2"

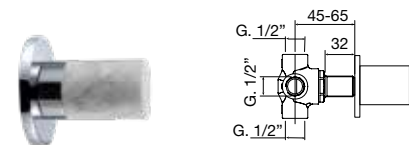

46 320 / 46 330 / 46 340 / 46 350 ●●●●
 Distribuidor empotrar 2/3/4/5 salidas
 Built-in diverter 2/3/4/5 ways
 Inverseur 2/3/4/5 voies à encastrer
 2/3/4/5 -wege-umsteller
 Встроенный дивертер на 2/3/4/5 выхода



46 714J ●●●●
 Grupo baño ducha 4 agujeros de repisa con ducha
 Bath shower 4 holes mixer with handshower
 Ensemble bain-douche 4 trous sur gorge avec ensemble de douche
 Wannenrand bad und duschmischer
 Смеситель на борт ванны для 4 отверстий с ручным душем



46 012 ●●●●
 Monomando baño ducha con accesorio
 Bath and shower mixer with accessories
 Mitigeur bain-douche avec accessoires
 Einhebel wannen und duschmischer
 Смеситель ванна / душ настенного монтажа с аксессуарами



46 015 ●●●●
 Monomando ducha con accesorios
 Shower mixer with accessories
 Mitigeur douche avec ensemble de douche
 Einhebel duschmischer
 Смеситель для душа настенного монтажа с аксессуарами



47 Twist



Twist



El ritmo industrial. Un grifo puede evocar una época pasada y a la vez la modernidad. Entre sonidos de revival, nace una colección forjada entre el ambiente fabril del siglo XIX y el diseño innovador del XXI.

The industrial rhythm. A faucet that can evoke a bygone era and modernity at the same time. Among sounds of revival, a collection forged between the factory atmosphere of the 19th century and the innovative design of the 21st century is born.



CR
Cromo
Chrome
Chrome
Chrom
Хром



CRNG
Cromo-Negro Mate
Chrome-Matt Black
Chrome-Noir Mate
Chrom-Schwarz matte
Хром- Чёрный матовый



CRRO
Cromo-Rojo
Chrome-Red
Chrome-Rouge
Chrom-Rot
Хром- Красный



CRGR
Cromo-Gris Cemento
Chrome-Grey Concrete
Chrome-Gris Ciment
Chrom-Grau Zement
Хром- Бетон



O
Oro
Gold
Or
Gold
Золото



OC
Oro cepillado
Brushed gold
Or brossé
Gebürstetes gold
Брашированное золото



47 002 OC
Monomando lavabo
Wash-basin mixer



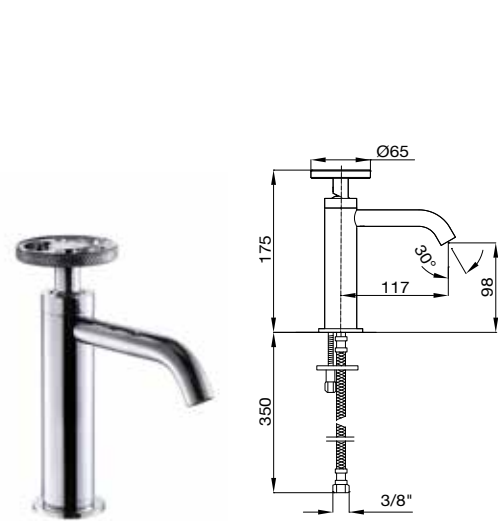

47 002 ●●●●●●●●
 Monomando lavabo
 Wash-basin mixer
 Mitigeur lavabo
 Einhebel waschtischmischer
 Однорычажный Смеситель для раковины

47 004 ●●●●●●●●
 Monomando lavabo válv. desag. click-clack
 Wash-basin mixer with click-clack waste
 Mitigeur lavabo avec vidage click-clack
 Einhebel waschtischmischer click-clack ablauf
 Однорычажный смеситель для раковины с донным клапаном

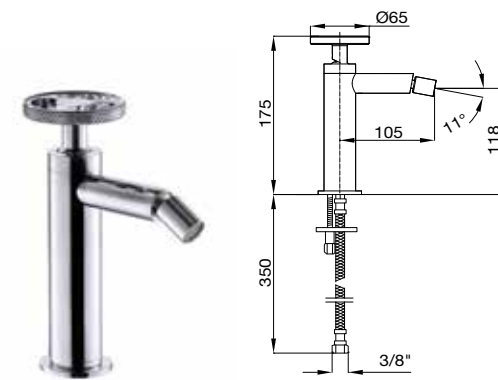

47 009 ●●●●●●●●
 Monomando bidé
 Bidet mixer
 Mitigeur bidet
 Einhebel bidetmischer
 Однорычажный смеситель для биде

47 011 ●●●●●●●●
 Monomando bidé válv. desag. click-clack
 Bidet mixer with click-clack waste
 Mitigeur bidet avec vidage click-clack
 Einhebel bidetmischer click-clack ablauf
 Однорычажный смеситель для биде с клапаном клик-клак

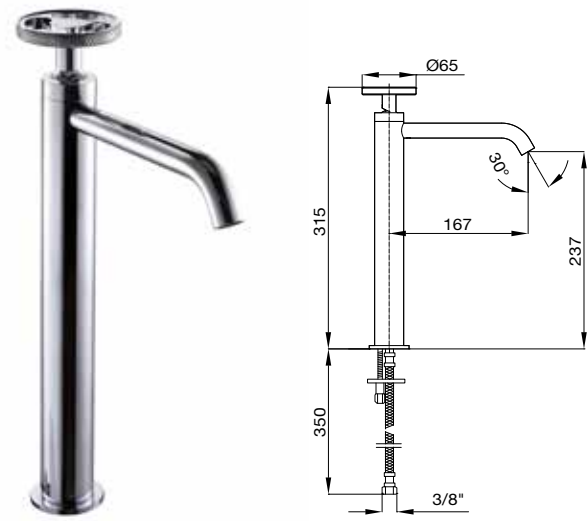
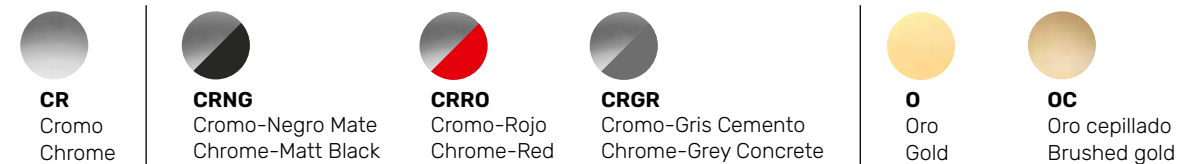

47 102 ●●●●●●●●
 Monomando lavabo alto
 High wash-basin mixer
 Mitigeur lavabo haut
 Einhebel waschtischmischer. Hohemn ausführung
 Однорычажный Смеситель для раковин высокий

47 104 ●●●●●●●●
 Monomando lavabo alto válv. desag. click-clack
 High wash-basin mixer with click-clack waste
 Mitigeur lavabo haut avec vidage click-clack
 Einhebel waschtischmischer. Hohemn ausführung mit click-clack ablauf
 Однорычажный смеситель для раковины высокий с клапаном клик-клак



47 002 CRNG
 Monomando lavabo
 Wash-basin mixer

47 102 CRRO
 Monomando lavabo alto
 High wash-basin mixer

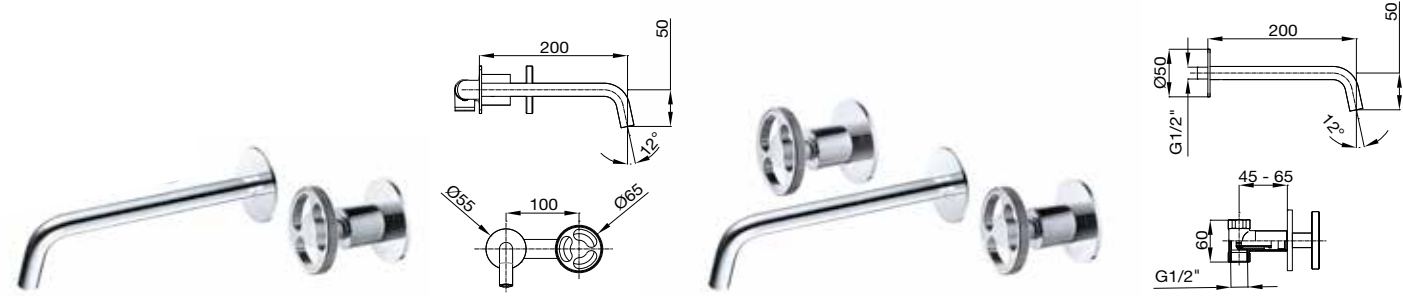

47 302 ●●●●●●

Monomando lavabo empotrado
Built-in single-lever wash-basin mixer
Mitigeur lavabo mural à encastrer
Unterputz Einhebel wannenmischer
Однорычажный смеситель для раковины настенный встроенный

47 305 ●●●●●●

Bimando lavabo empotrado
Concealed 3 holes wash basin mixer
Mélangeur de lavabo 3 trous à encastrer
Unterputz 3-Loch Waschtischmischer
Встроенный смеситель для раковины на 3 отверстия

47 304 ●●●●●●

Monomando lavabo empotrado válv. desag. click-clack
Built-in single-lever wash-basin with click-clack waste
Mitigeur lavabo mural à encastrer avec vidage click-clack
Unterputz Einhebel wannenmischer. Click-clack ablauf
Однорычажный смеситель для раковины настенный встроенный с копланом клик-клак

47 307 ●●●●●●

Bimando lavabo empotrado válv. desag. click-clack
Concealed 3 holes wash basin mixer with click-clack waste
Mélangeur de lavabo 3 trous à encastrer avec vidage click-clack
Unterputz 3-Loch Waschtischmischer mit click-clack Ablaufgarnitur
Встроенный смеситель для раковины на 3 отверстия со сливом клик-клак

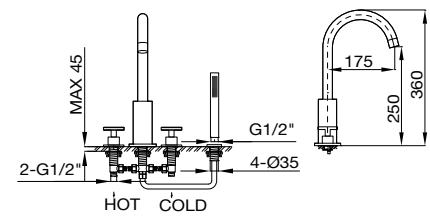

47 714J ●●●●●●

Grupo baño ducha 4 agujeros de repisa con ducha
Bath shower 4 holes mixer with handshower
Ensemble bain-douche 4 trous sur gorge avec ensemble de douche
Wannenrand bad und duschmischer
Смеситель на борт ванны для 4 отверстий с ручным душем

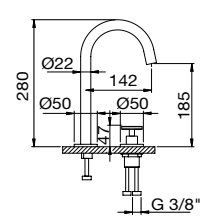

47 702 ●●●●●●

Monomando lavabo repisa
Deck mounted single-lever wash basin mixer
Mitigeur de lavabo 2 trous sur gorge
Einhand Waschtischmischer 2-Loch
Однорычажный смеситель на столешницу / раковину

47 704 ●●●●●●

Monomando lavabo repisa válv. desag. click-clack
Deck mounted single-lever wash basin mixer with click-clack waste
Mitigeur de lavabo 2 trous sur gorge avec vidage click-clack
Einhand Waschtischmischer mit click-clack Ablaufgarnitur
Однорычажный смеситель на столешницу / раковину со сливом клик-клак

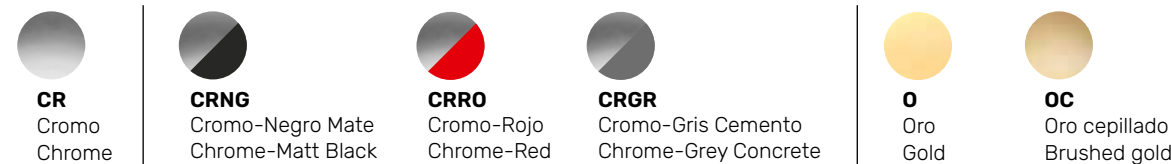

47 005 O
Juego lavabo caño central
Wash basin in 3 holes mixer

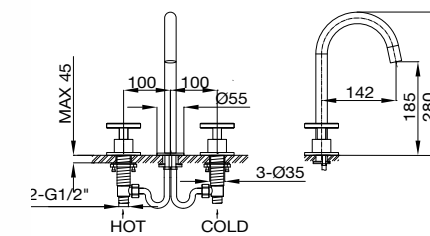

47 005J ●●●●●●

Juego lavabo caño central
Wash basin in 3 holes mixer
Mélangeur 3 trous pour lavabo
Waschtischmischer dreilochbatterie
Смеситель для раковины на 3 отверстия

47 075J ●●●●●●

Juego lavabo caño central válv. desag. click-clack
Wash basin in 3 holes mixer with click-clack waste
Batterie trois trous pour lavabo avec vidage click-clack
Waschtischmischer dreilochbatterie mit click-clack ablauf
Смеситель для раковины на 3 отверстия с клапаном клик-клак

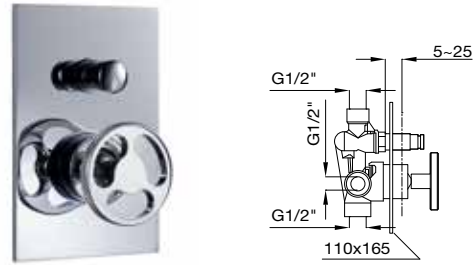

47 312 ●●●●●●●●

Monomando empotrar ducha
Built-in bath shower mixer
Mitigeur bain-douche à encastrer
Unterputz wannen und duschmischer
Однорычажный Смеситель встроенный ванна душ

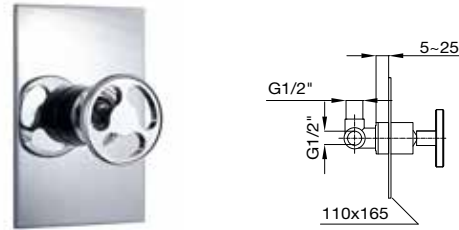

47 315 ●●●●●●●●

Monomando empotrar ducha
Built-in shower mixer
Ensemble douche à encastrer
Unterputz duschmischer
Встроенный термостатический смеситель на 1 выход



47 016 ●●●●●●●●

Llave de paso empotrar 1/2"
Built-in key step 1/2"
Robinet d'arrêt de 1/2"
Unterputz-ventil 1/2"
Кран встроенный 1/2"

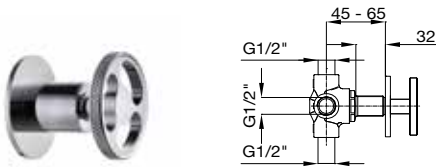

47 320 / 47 330 / 47 340 / 47 350 ●●●●●●●●

Distribuidor empotrar 2/3/4/5 salidas
Built-in diverter 2/3/4/5 ways
Inverseur 2/3/4/5 voies à encastrer
2/3/4/5-wege-umsteller
Встроенный дивертер на 2/3/4/5 выхода

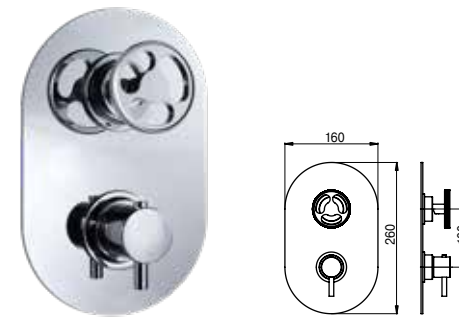

47 601/47 602 / 47 603 ●●●●●●●●

Termostático baño ducha empotrar con inversor 1/2/3 vías
Thermostatic concealed bath shower with diverter 1/2/3 ways
Mitigeur thermostatique bain/douche à encastrer avec inverseur 1/2/3 vois
Thermostat für brause/wannenbatterie mit umstellung 1/2/3 abgängen
Термостатический смеситель встроенный душ и ванна на 1/2/3 выхода

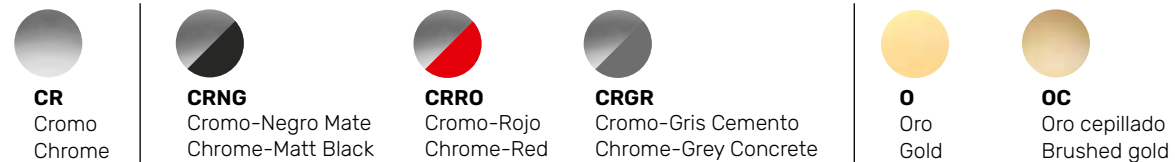

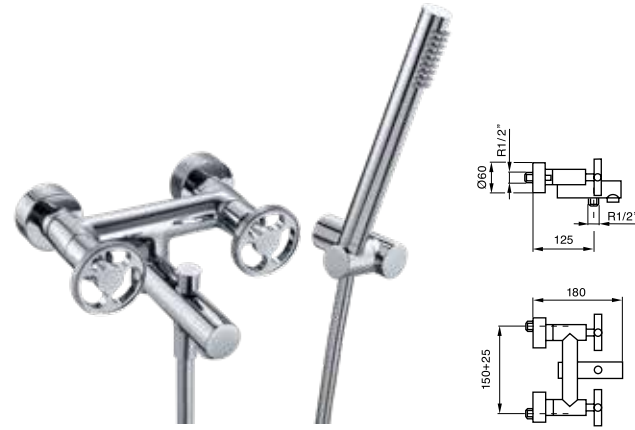

47 012 ●●●●●●

Grupo baño ducha con accesorios
Wall mounted bath shower mixer with accessories
Mélangeur bain-douche avec accessoires
Wannen und dusch batterie mit zuberhör
Смеситель ванна / душ настенного монтажа с аксессуарами



47 015 ●●●●●●

Grupo ducha con accesorios
Shower mixer with accessories
Mélangeur douche avec ensemble de douche
Dusch batterie mit zuberhör
Смеситель для душа настенного монтажа с аксессуарами

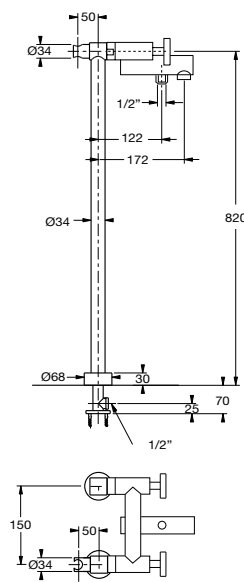

47 512 ●●●●●●

Grupo baño ducha con columna suelo de 820 mm
Bath shower group with floor-standing column of 820 mm
Mélangeur bain-douche sur colonne de 820 mm
Wannen batterie mit 820 mm hohen boden anschluss.
Handbrause und flexiblen schlauch
Смеситель ванна / душ с напольными колоннами 820 mm



CR
Cromo
Chrome



CRNG
Cromo-Negro Mate
Chrome-Matt Black



CRRO
Cromo-Rojo
Chrome-Red



CRGR
Cromo-Gris Cemento
Chrome-Grey Concrete



O
Oro
Gold



OC
Oro cepillado
Brushed gold



41 316L



316L



La nobleza del acero
Una pieza técnicamente perfecta, con el más distinguido de los aceros inoxidable. Una apuesta minimalista por un baño noble, sobrio y singular.

The nobility of steel
A technically perfect piece, made with the most distinguished stainless steel. A minimalist bet for a noble, sober and unique bathroom.

INOX
Acero Inoxidable AISI 316L
Stainless Steel AISI 316L
Acier Inoxydable AISI 316L
НЕРЖАВЕЮЩАЯ СТАЛЬ AISI 316L

41 316L



41 302 INOX
Monomando lavabo empotrado
Built-in single-lever wash-basin mixer



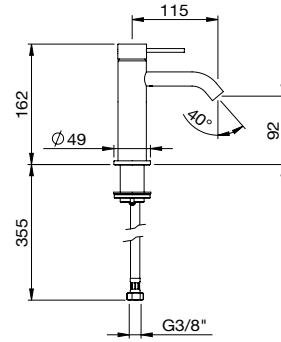

41 002
 Monomando lavabo
 Wash-basin mixer
 Mitigeur lavabo
 Однорычажный Смеситель для раковины

41 004
 Monomando lavabo válv. desag. click-clack
 Wash-basin mixer with click-clack waste
 Mitigeur lavabo avec vidage click-clack
 Однорычажный смеситель для раковины с донным клапаном

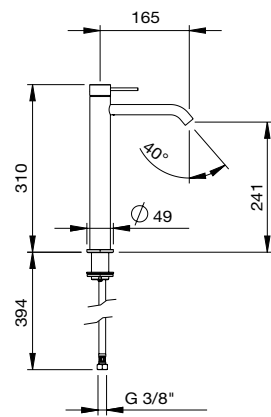

41 102
 Monomando lavabo alto
 High wash-basin mixer
 Mitigeur lavabo haut
 Однорычажный Смеситель для раковин высокий

41 104
 Monomando lavabo alto válv. desag. click-clack
 High wash-basin mixer with click-clack waste
 Mitigeur lavabo haut avec vidage click-clack
 Однорычажный смеситель для раковины высокий с клапаном клик-клак

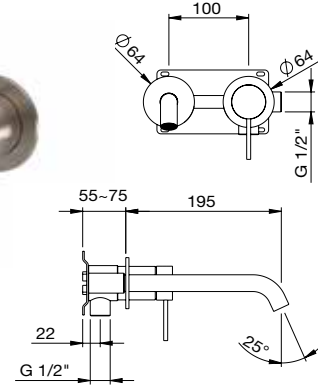

41 302
 Monomando lavabo empotrado
 Built-in single-lever wash-basin mixer
 Mitigeur lavabo mural à encastrer
 Однорычажный смеситель для раковины настенный встроенный

41 304
 Monomando lavabo empotrado válv. desag. click-clack
 Built-in single-lever wash-basin with click-clack waste
 Mitigeur lavabo mural à encastrer avec vidage click-clack
 Однорычажный смеситель для раковины настенный встроенный с копаном клик-клак

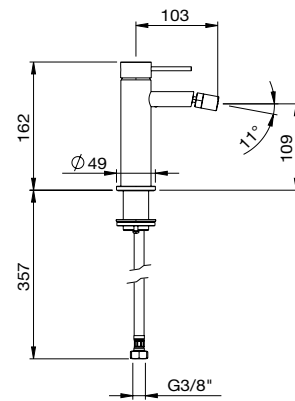

41 009
 Monomando bidé
 Bidet mixer
 Mitigeur bidet
 Однорычажный смеситель для биде

41 011
 Monomando bidé válv. desag. click-clack
 Bidet mixer with click-clack waste
 Mitigeur bidet avec vidage click-clack
 Однорычажный смеситель для биде с клапаном клик-клак

INOX
 Acero Inoxidable AISI 316L
 Stainless Steel AISI 316L

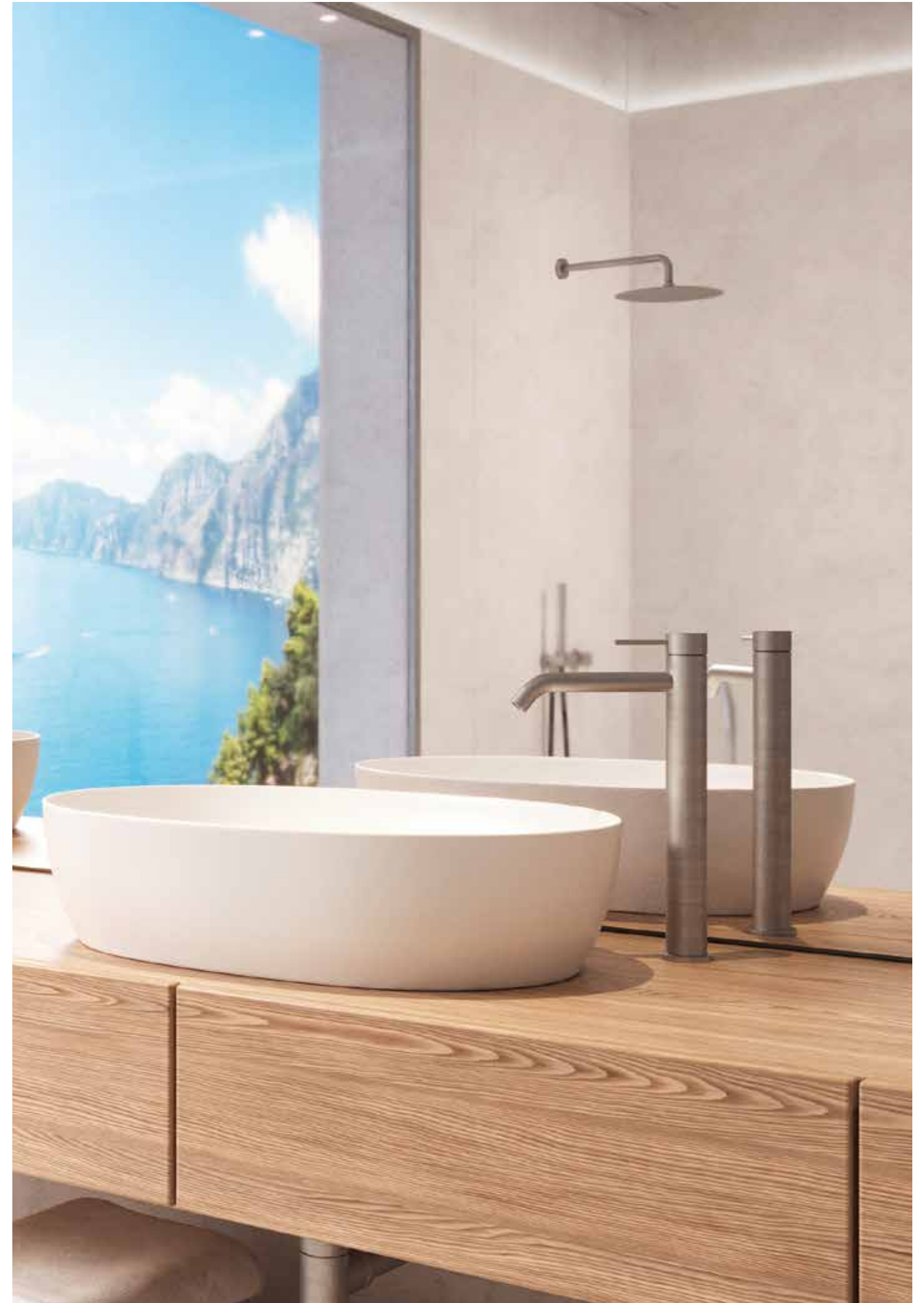



41 316L

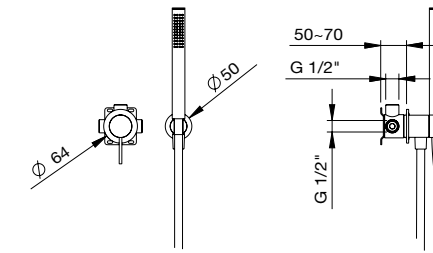

41 317

Conjunto monomando ducha empotrado 1 vía con toma con soporte, ducha y flexo 1,70 m
 Concealed shower set with shower mixer 1-way, wall outlet with support, handshower and flexible hose 1,70 m
 Mitigeur de douche à encastrer 1-voie avec ensemble de douchette à main
 Встроенный душевой комплект на 1 выход с соединителем с держателем, ручным душем и душевым шлангом 1,70 м

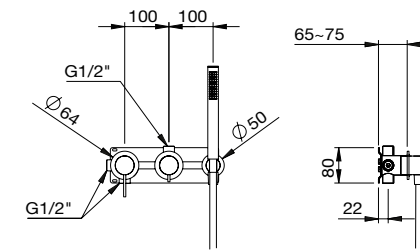

41 322

Conjunto monomando ducha empotrado 2 vías con toma con soporte, ducha y flexo 1,70 m
 Concealed shower set with shower mixer, diverter 2 ways, wall outlet with support, handshower and flexible hose 1,70 m
 Ensemble à encastrer avec mitigeur de douche, inverseur à encastrer 2-voies et ensemble de douchette à main
 Встроенный душевой комплект на 2 выходов с соединителем с держателем, ручным душем шлангом 1,70 м

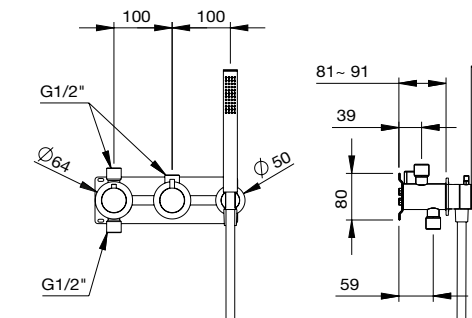

41 652

Conjunto termostático ducha empotrado 2 vías con toma con soporte, ducha y flexo 1,70 m
 Concealed shower set with thermostatic mixer, diverter 2 ways, wall outlet with support, handshower and flexible hose 1,70 m
 Ensemble à encastrer avec mitigeur thermostatique de douche, inverseur à encastrer 2-voies et ensemble de douchette à main
 Термостатический встроенный душевой комплект на 2 выходов с соединителем с держателем, и душевым ручным душем и душевым шлангом 1,70 м

INOX
 Acero Inoxidable AISI 316L
 Stainless Steel AISI 316L

MAIER

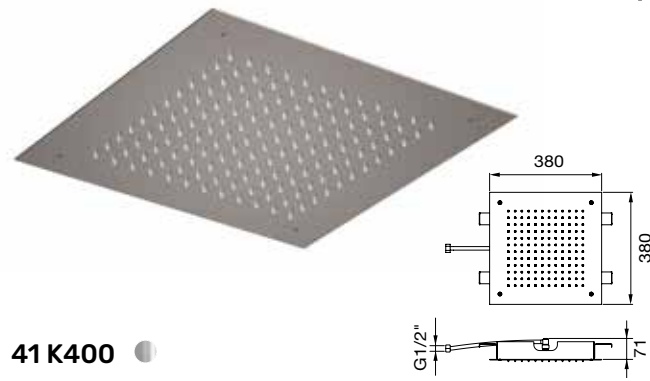

41 K400

Rociador para falso techo 380x380 mm
False ceiling showerhead 380x380 mm
Pomme de douche pour faux plafond 380x380 mm
Душевая лейка для подвесного потолка 380x380 mm

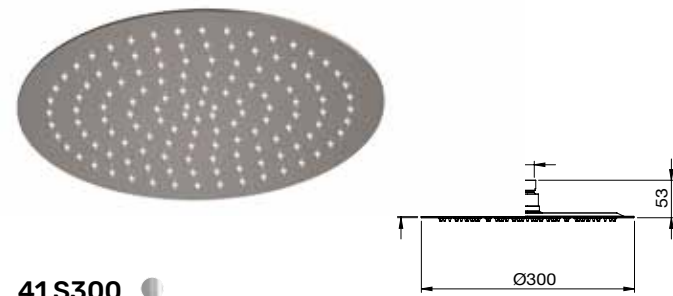

41 S300

Rociador ducha redondo D300 mm h 2mm
Round showerhead D300 mm h 2mm
Pomme de douche ronde D300 mm h 2mm
Распылитель душ круглый д300 mm h 2mm



41 C403

Rociador cascada a pared inox 240x140 mm
Waterfall inox showerhead wall mounted 240x140 mm
Pomme de douche cascade mural 240x140 mm
Настенная душевая лейка нержавеющей эффект каскада 240x140 mm



41 180

Braço ducha pared redondo 1/2" 35 cm
Round wall arm 1/2" 35 cm
Bras de douche sortie mural ronde 1/2" x 35 cm
Горизонтальный поворотный душевой кронштейн стена 1/2" 35 см

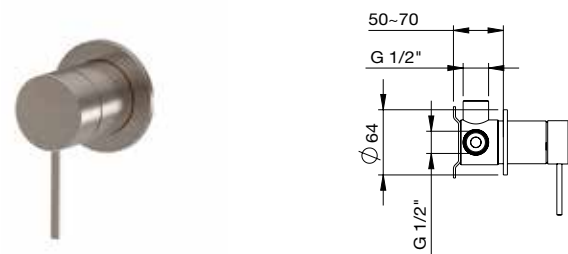

41 315

Monomando empotrar ducha
Built-in shower mixer
Mitigeur de douche à encastrer
Встроенный термостатический смеситель на 1 выход

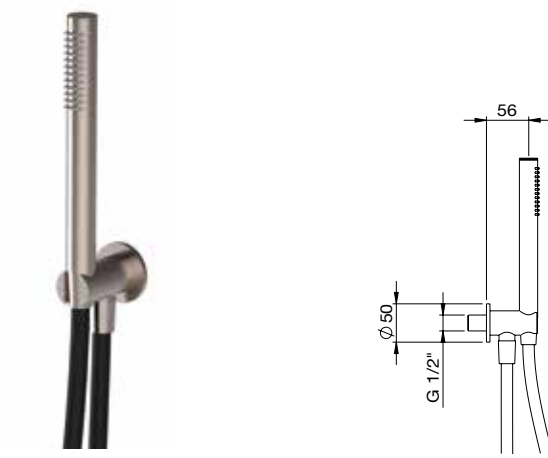

41 130

Toma con soporte, ducha de mano inox 316L y flexo 1,70 m PVC
Water outlet with support, handshower 316L and flexible hose 1,70 m PVC
Ensemble de douchette à main 316L
держатель ручного душа с подводом воды, с ручным душем 316L и гибким шлангом 1,70 м PVC

INOX
Acero Inoxidable AISI 316L
Stainless Steel AISI 316L

41 316L



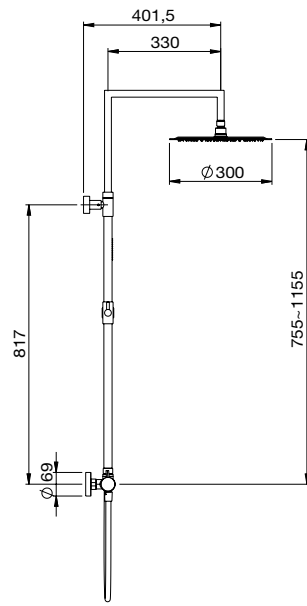

41 413 S300

Conjunto monomando con columna ducha cilíndrica telescópica y rociador D300
 Shower mixer and round telescopic shower column unit with showerhead D300
 Mitigeur douche et barre de douche ronde télescopique avec pomme de douche D300
 Набор с колонкой душа целендр. телескопический распылитель д300

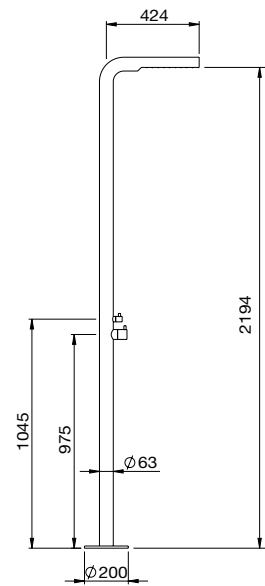

41 515

Ducha de pie para exterior con grifo monomando, rociador integrado y set de ducha de mano cilíndrica
 Outdoor free standing shower with single-lever mixer, built-in rain shower function and hand shower set
 Douche extérieure sur pied avec mitigeur, pomme de douche intégré et ensemble de douchette à main
 уличная свободностоящая душевая стойка с однорычажным смесителем, интегрированным тропическим душем и ручным душем

INOX
 Acero Inoxidable AISI 316L
 Stainless Steel AISI 316L



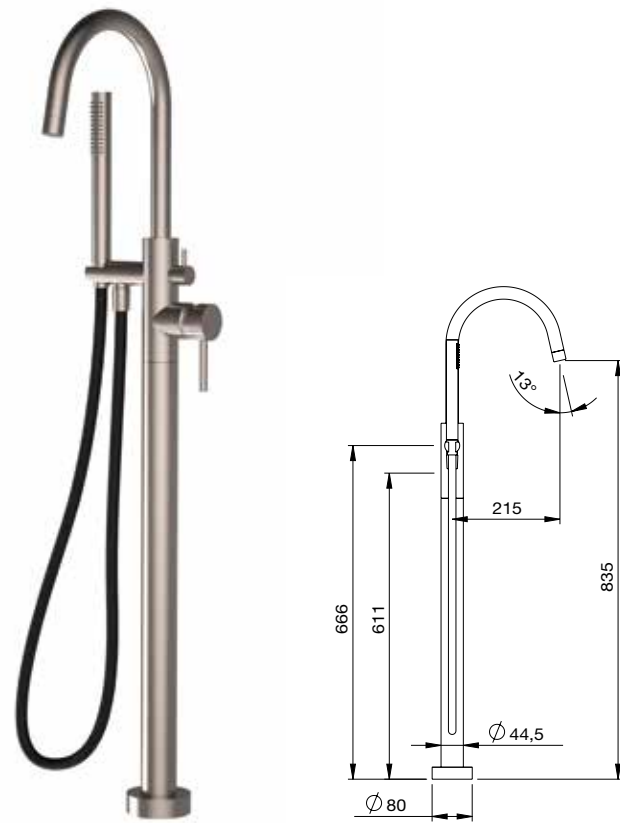

41 512

Grifo exento baño ducha 983 mm redondo con accesorios
 Floorstanding bath shower mixer 983 mm round with accessories
 Mitigeur colonne bain douche 983 mm rond avec accessoires
 напольный смеситель для ванны 983 мм круглый с лейкой

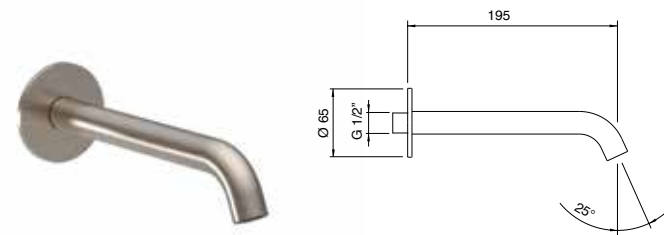

Caño bañera mural redondo 1/2"
 Round wall bath tub spout 1/2"
 Bec fondu pour baignoire 1/2" ronde
 Поворотный излив настенный круглый 1/2"

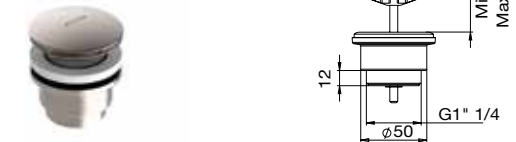

21 600 Univ

Válvula click-clack 1 1/4" redonda con y sin rebosadero
 Click-clack 1 1/4" waste round
 Vidage click-clack 1 1/4" ronde
 клапан клик-клак 1 1/4" круглый, с и без слива



41 074

Monomando cocina con ducha extraíble de 2 funciones
 Sink Mixer pull-out spray 2 jets
 Mitigeur évier douchette extractible 2 fonctions
 смеситель для кухни с вытяжным душем. 2 виды струи



41 064

Monomando cocina
 Sink Mixer
 Mitigeur évier
 смеситель для кухни

INOX
 Acero Inoxidable AISI 316L
 Stainless Steel AISI 316L



43 Mini Star



Mini Star



Timón de fiabilidad. La elegancia suele ser sinónimo de volver a la simplicidad. Mini star es la colección de los baños sobrios y gusto contemporáneo. Una garantía para relacionarse con el agua con discreción y durabilidad.

The reliability helm. Elegance is often synonymous with a return to simplicity. Mini Star is the collection for sober bathrooms and contemporary taste. A guarantee to interact with water with discretion and durability.



CR
Cromo
Chrome
Chrome
Chrom
Хром



NG
Negro mate
Matt black
Noir mate
Schwarz matte
Черное



BL
Blanco mate
Matt white
Blanche mate
Weisse matte
Белое



O
Oro
Gold
Or
Gold
Золото



OR
Oro rosa
Rose gold
Or rosé
Rose Gold
Розовое золото



OC
Oro cepillado
Brushed gold
Or brossé
Gebürstetes gold
Брашированное золото



CO
Cobre mate
Matt copper
Cuivre mat
Kupfer matt
Матовая медь



BR
Bronce antiguo mate
Old matt bronze
Vieux bronze mat
Altes bronze matt
Матовая состаренная бронза



NI
Níquel cepillado mate
Matt brushed nickel
Matt brossé nickel
Matt gebürstetes Nickel
Брашированный матовый никел



43 102 OR
Monomando lavabo alto
High wash-basin mixer





43 702 0
Monomando lavabo repisa
Deck mounted single-lever wash basin mixer



CR
Cromo
Chrome



BL
Blanco mate
Matt white



NG
Negro mate
Matt black



CO
Cobre mate
Matt copper



BR
Bronce antiguo mate
Old matt bronze



NI
Níquel cepillado mate
Matt brushed nickel



O
Oro
Gold



OR
Oro rosa
Rose gold



OC
Oro cepillado
Brushed gold

MAIER



43 Mini Star

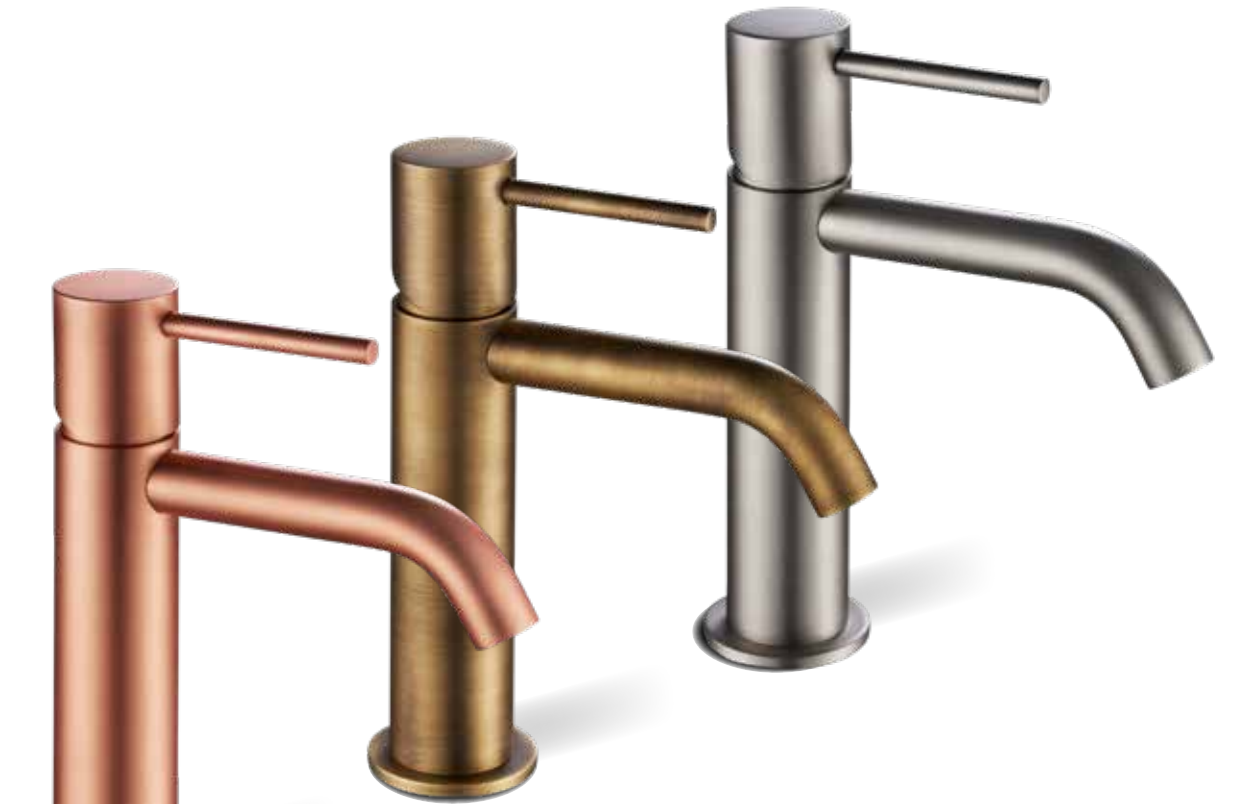

43 002
Monomando lavabo
Wash-basin mixer

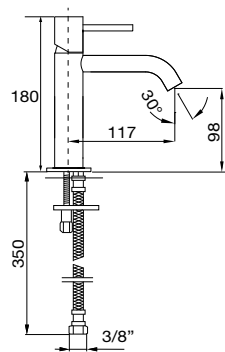

43 002 ●●●●●●●●●●
 Monomando lavabo
 Wash-basin mixer
 Mitigeur lavabo
 Einhebel waschtischmischer
 Однорычажный Смеситель для раковины

43 004 ●●●●●●●●●●
 Monomando lavabo válv. desag. click-clack
 Wash-basin mixer with click-clack waste
 Mitigeur lavabo avec vidage click-clack
 Einhebel waschtischmischer click-clack ablauf
 Однорычажный смеситель для раковины с донным клапаном

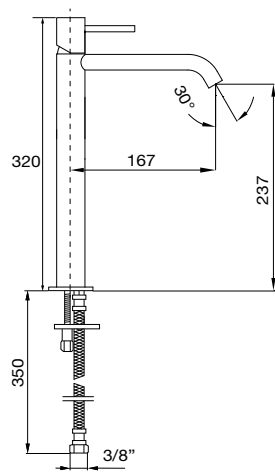

43 102 ●●●●●●●●●●
 Monomando lavabo alto
 High wash-basin mixer
 Mitigeur lavabo haut
 Einhebel waschtischmischer. Hohemn ausführung
 Однорычажный Смеситель для раковин высокий

43 104 ●●●●●●●●●●
 Monomando lavabo alto válv. desag. click-clack
 High wash-basin mixer with click-clack waste
 Mitigeur lavabo haut avec vidage click-clack
 Einhebel waschtischmischer. Hohemn ausführung mit click-clack ablauf
 Однорычажный смеситель для раковины высокий с клапаном клик-клак

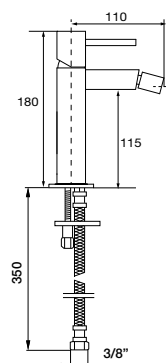

43 009 ●●●●●●●●●●
 Monomando bidé
 Bidet mixer
 Mitigeur bidet
 Einhebel bidetmischer
 Однорычажный смеситель для биде

43 011 ●●●●●●●●●●
 Monomando bidé válv. desag. click-clack
 Bidet mixer with click-clack waste
 Mitigeur bidet avec vidage click-clack
 Einhebel bidetmischer click-clack ablauf
 Однорычажный смеситель для биде с клапаном клик-клак

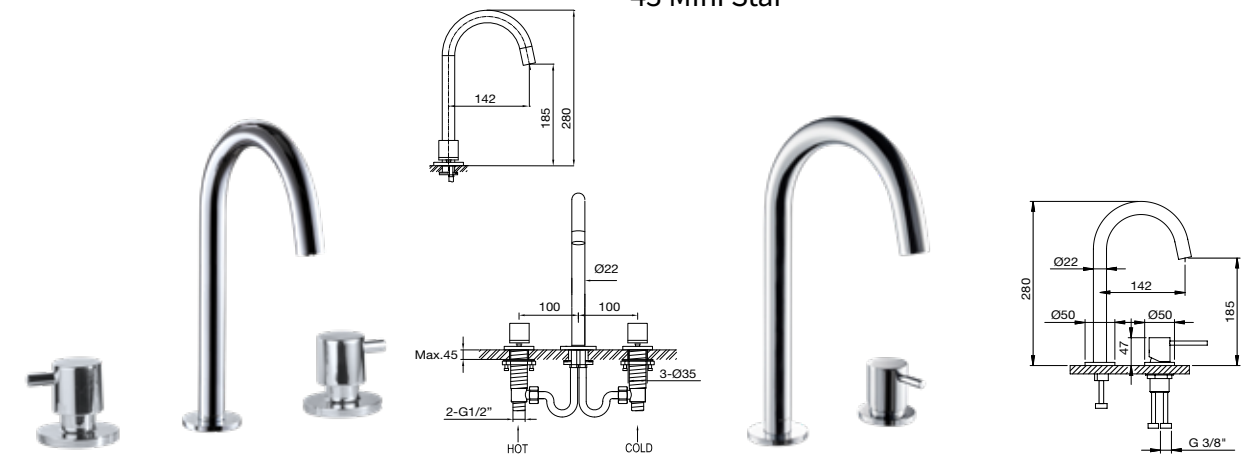

43 Mini Star

43 005J ●●●●●●●●●●
 Juego lavabo caño central
 Wash basin in 3 holes mixer
 Mélangeur 3 trous pour lavabo
 Waschtischmischer dreilochbatterie
 Смеситель для раковины на 3 отверстия

43 702 ●●●●●●●●●●
 Monomando lavabo repisa
 Deck mounted single-lever wash basin mixer
 Mitigeur de lavabo 2 trous sur gorge
 Einhand Waschtischmischer 2-Loch
 Однорычажный смеситель на столешницу / раковину

43 075J ●●●●●●●●●●
 Juego lavabo caño central válv. desag. click-clack
 Wash basin in 3 holes mixer with click-clack waste
 Batterie trois trous pour lavabo avec vidage click-clack
 Waschtischmischer dreilochbatterie mit click-clack ablauf
 Смеситель для раковины на 3 отверстия с клапаном клик-клак

43 704 ●●●●●●●●●●
 Monomando lavabo repisa válv. desag. click-clack
 Deck mounted single-lever wash basin mixer with click-clack waste
 Mitigeur de lavabo 2 trous sur gorge avec vidage click-clack
 Einhand Waschtischmischer mit click-clack Ablaufgarnitur
 Однорычажный смеситель на столешницу / раковину со сливом клик-клак



43 003 ●●●●●●●●●●
 Monomando lavabo
 Wash-basin mixer
 Mitigeur lavabo
 Einhebel waschtischmischer
 Однорычажный Смеситель для раковины

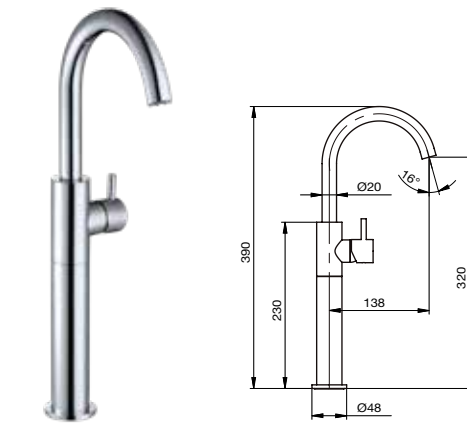

43 103 ●●●●●●●●●●
 Monomando lavabo alto
 High wash-basin mixer
 Mitigeur lavabo haut
 Einhebel waschtischmischer. Hohemn ausführung
 Однорычажный Смеситель для раковин высокий

43 007 ●●●●●●●●●●
 Monomando lavabo válv. desag. click-clack
 Wash-basin mixer with click-clack waste
 Mitigeur lavabo avec vidage click-clack
 Einhebel waschtischmischer click-clack ablauf
 Однорычажный смеситель для раковины с донным клапаном

43 107 ●●●●●●●●●●
 Monomando lavabo alto válv. desag. click-clack
 High wash-basin mixer with click-clack waste
 Mitigeur lavabo haut avec vidage click-clack
 Einhebel waschtischmischer. Hohemn ausführung mit click-clack ablauf
 Однорычажный смеситель для раковины высокий с клапаном клик-клак

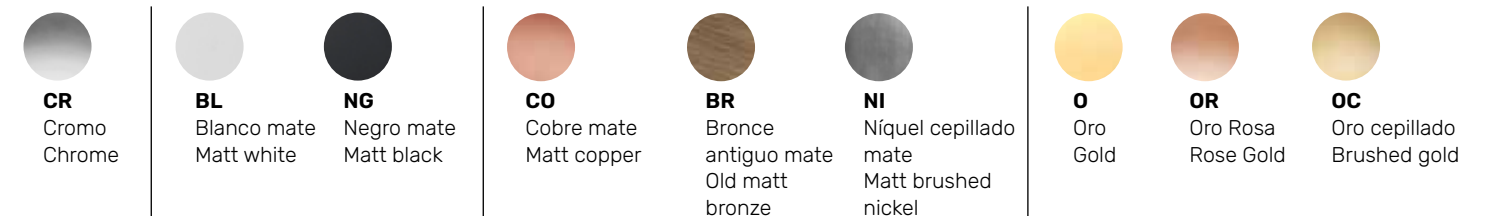



43 302

Monomando lavabo empotrado
Built-in single-lever wash-basin mixer
Mitigeur lavabo mural à encastrer
Unterputz Einhebel wannenmischer
Однорычажный смеситель для раковины настенный встроенный



43 305

Bimando lavabo empotrado
Concealed 3 holes wash basin mixer
Mélangeur de lavabo 3 trous à encastrer
Unterputz 3-Loch Waschtischmischer
Встроенный смеситель для раковины на 3 отверстия

43 304

Monomando lavabo empotrado válv. desag. click-clack
Built-in single-lever wash-basin with click-clack waste
Mitigeur lavabo mural à encastrer avec vidage click-clack
Unterputz Einhebel wannenmischer. Click-clack ablauf
Однорычажный смеситель для раковины настенный встроенный с копаном клик-клак

43 307

Bimando lavabo empotrado válv. desag. click-clack
Concealed 3 holes wash basin mixer with click-clack waste
Mélangeur de lavabo 3 trous à encastrer avec vidage click-clack
Unterputz 3-Loch Waschtischmischer mit click-clack Ablaufgarnitur
Встроенный смеситель для раковины на 3 отверстия со сливом клик-клак

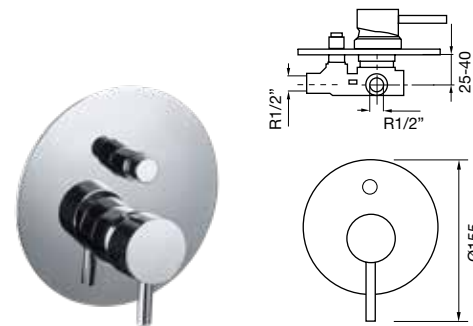

43 312

Monomando empotrar baño ducha
Built-in bath shower mixer
Mitigeur bain-douche à encastrer
Unterputz wannen und duschmischer
Однорычажный Смеситель встроенный ванна душ

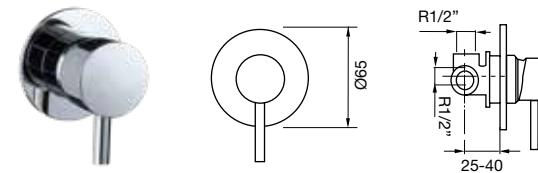

43 315

Monomando empotrar ducha
Built-in shower mixer
Ensemble douche à encastrer
Unterputz duschmischer
Встроенный смеситель на 1 выход

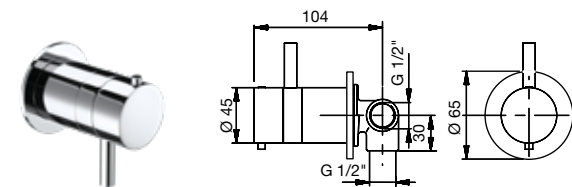

43 611

Grifo termostático ducha empotrar 1 vía
Thermostatic concealed shower mixer 1 way
Mitigeur thermostatique douche à encastrer 1 voi
Unterputz thermostat brausemischer 1 weg
Встроенный термостатический смеситель для душа на 1 выход

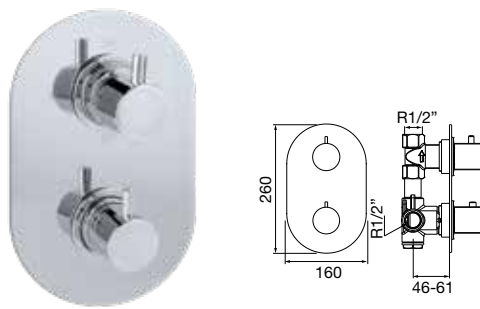

43 601/43 602 / 43 603

Termostático baño ducha empotrar con inversor 1/2/3 vías
Thermostatic concealed bath shower with diverter 1/2/3 ways
Mitigeur thermostatique bain/douche à encastrer avec inverseur 1/2/3 vois
Thermostat für brause/wannenbatterie mit umstellung 1/2/3 abgängen
Термостатический смеситель встроенный душ и ванна на 1/2/3 выхода

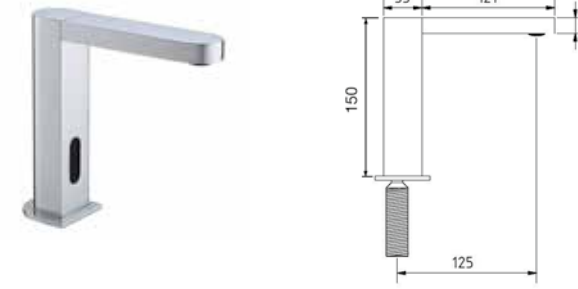

43 801

Grifo electrónico 1 agua
Sensor basin tap cold water
Robinet électronique sur plage 1 eau
Berührunglose elektronische waschtischarmatur
Смеситель с инфракрасным датчиком включения, только холодная вода

43 802

Grifo electrónico 2 aguas
Sensor basin tap cold and hot water
Robinet électronique sur plage froid et chaud
Berührunglose elektronische mischwaschtischarmatur
Смеситель с инфракрасным датчиком включения, холодная и горячая вода



43 012

Monomando baño ducha con accesorios
Bath and shower mixer with accessories
Mitigeur bain-douche avec accessoires
Einhebel wannen und duschmischer
Смеситель ванна / душ настенного монтажа с аксессуарами



43 015

Monomando ducha con accesorios
Shower mixer with accessories
Mitigeur douche avec ensemble de douche
Einhebel Duschmischer
Смеситель для душа настенного монтажа с аксессуарами

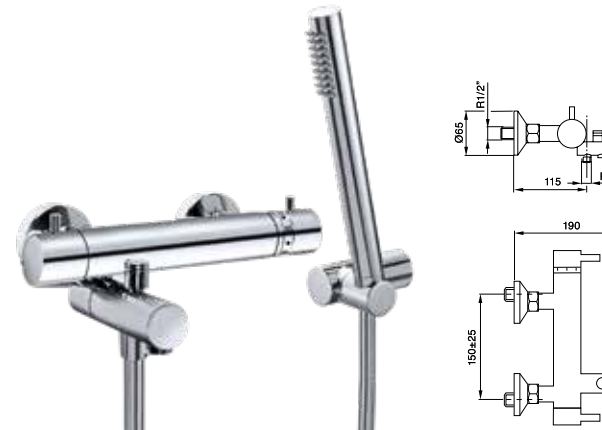

43 212

Batería termostática baño ducha con accesorios
Thermostatic bath shower with accessories
Mitigeur thermostatique bain-douche avec accessoires
Wannen und dusch thermostat batterie mit zuberhör
Смеситель термостат ванна / душ с аксессуарами

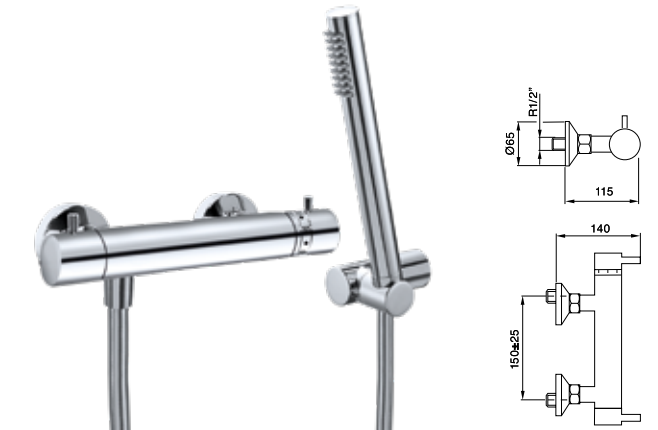

43 215

Batería termostática ducha con accesorios
Thermostatic shower with accessories
Thermostatique mitigeur douche avec accessoires
Dusch thermostat batterie mit zuberhör
Смеситель для душа с аксессуарами

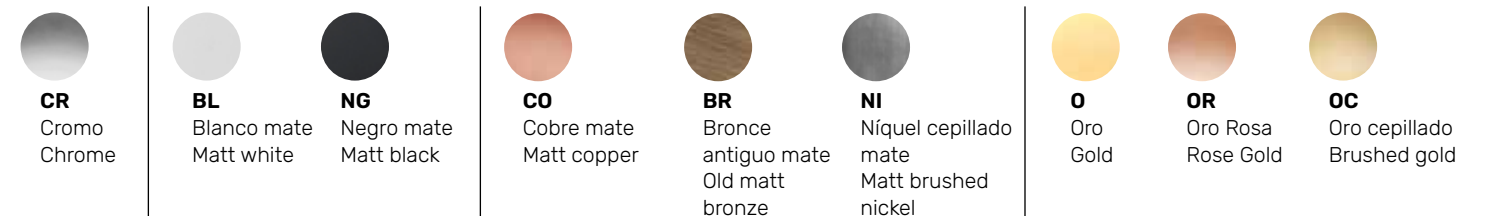



43 716J ●●●●●●●●●●

Monomando bañera repisa 3 agujeros con ducha y flexo 1,50 m
Deck mounted single-lever bath shower 3 holes mixer with handshower 1,50 m
Mitigeur de bain douche 3 trous sur gorge avec ensemble de douche
Wannenrand Einhandmischer 3-Loch mit Handbrause
Однорычажный смеситель на борт ванны на 3 отверстия с ручным душем

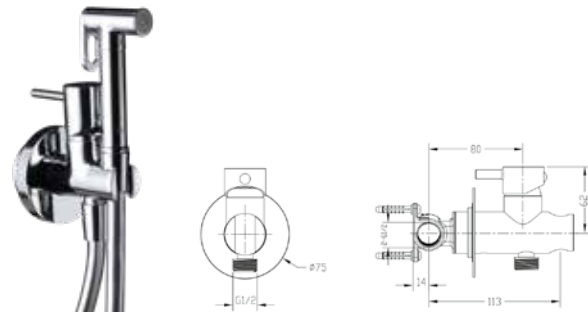

43 800 ●●●●●●●●●●

Monomando bidé empotrado con soporte, duchita y flexo 1,25 m
Concealed single-lever bidet set with support, shut-off handshower and flexible hose 1,25 m
Mitigeur de bidet à encastrer avec support, douchette et flexible 1,25 m
Unterputz Bidet Einhandmischer mit Handbrause und flexiblem Schlauch 1,25 m
Встроенный гигиенический душ с ручной лейкой и гибким шлангом 1,25 m.



43 016 ●●●●●●●●●●

Llave de paso empotrar 1/2"
Built-in key step 1/2"
Robinet d'arrêt de 1/2"
Unterputz-ventil 1/2"
Кран встроенный 1/2"

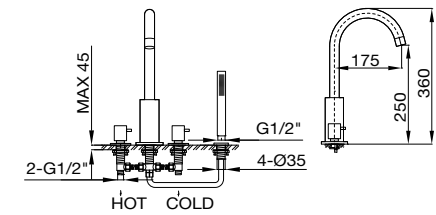

43 714J ●●●●●●●●●●

Grupo baño ducha 4 agujeros de repisa con ducha
Bath shower 4 holes mixer with handshower
Ensemble bain-douche 4 trous sur gorge avec ensemble de douche
Wannenrand bad und duschmischer
Смеситель на борт ванны для 4 отверстий с ручным душем



43 718 ●●●●●●●●●●

Grupo baño ducha 5 agujeros de repisa con ducha
Bath shower 5 holes mixer with handshower
Ensemble bain-douche 5 trous sur gorge avec ensemble de douche
Wannenrand bad und duschmischer
Смеситель на борт ванны для 5 отверстий с ручным душем

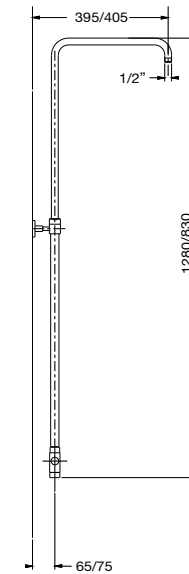

43 415-D200 ●●●●●●●●●●

Conjunto termostático con columna ducha cilíndrica telescópica y rociador D200
Thermostatic and round telescopic shower column unit with showerhead D200
Mitigeur thermostatique et barre de douche ronde télescopique avec pomme de douche D200
Thermostat brausegarnitur runde brausegarniture D200 mm bewegliche kopfbrause. Handbrause und brausehalter
Термостатический душевой комплект с колонной цилиндрической телескопической, с верхним душем D200

43 415-D300 ●●●●●●●●●●

Conjunto termostático con columna ducha cilíndrica telescópica y rociador D300
Thermostatic and round telescopic shower column unit with showerhead D300
Mitigeur thermostatique et barre de douche ronde télescopique avec pomme de douche D300
Thermostat brausegarnitur runde brausegarniture D300 bewegliche kopfbrause. Handbrause und brausehalter
Термостатический душевой комплект с колонной цилиндрической телескопической, с верхним душем D300

***43 413-D200/D300** ●●●●●●●●●●

Con grifo monomando
With single-lever mixer



MINI STAR ACCESSORIES

pag. 398



43 320 / 43 330 / 43 340 / 43 350 ●●●●●●●●●●

Distribuidor empotrar 2/3/4/5 salidas
Built-in diverter 2/3/4/5 ways
Inverseur 2/3/4/5 voies à encastrer
2/3/4/5-wege-umsteller
Встроенный дивертер на 2/3/4/5 выхода

MAIER



43 317 ●●●●●●●●●●

Conjunto monomando ducha empotrado 1 vía con toma con soporte, ducha y flexo 1,70 m
 Concealed shower set with shower mixer 1-way, wall outlet with support, handshower and flexible hose 1,70 m
 Встроенный душевой комплект на 1 выход с соединителем с держателем, ручным душем и душевым шлангом 1,70 м



43 362 /43 363 /43 364 /43 365 ●●●●●●●●●●

Conjunto bimando ducha empotrado 2/3/4/5 vías con toma con soporte, ducha y flexo 1,70 m
 Concealed bath shower set with two-handle shower keys, diverter 2/3/4/5 ways, wall outlet with support, handshower and flexible hose 1,70 m
 Встроенный душевой комплект на 4 отверстия на 2/3/4/5 выходов с соединителем с держателем, ручным душем и душевым шлангом 1,70 м



43 322 /43 323 /43 324 /43 325 ●●●●●●●●●●

Conjunto monomando ducha empotrado 2/3/4/5 vías con toma con soporte, ducha y flexo 1,70 m
 Concealed shower set with shower mixer 1-way, diverter 2/3/4/5 ways, wall outlet with support, handshower and flexible hose 1,70 m
 Встроенный душевой комплект на 2/3/4/5 выходов с соединителем с держателем, ручным душем и душевым шлангом 1,70 м



43 316 ●●●●●●●●●●

Conjunto monomando 2 salidas con toma con soporte, ducha y flexo 1,70 m
 Concealed bath shower set with mixer 2-ways, wall outlet with support, handshower and flexible hose 1,70 m
 Встроенный душевой комплект однорычажный на 2 выхода с соединителем с держателем, ручным душем и душевым шлангом 1,70 м



43 314 ●●●●●●●●●●

Conjunto monomando baño ducha empotrado 2/3/4/5 vías con caño, toma con soporte, ducha y flexo 1,70 m
 Concealed bath shower set with shower mixer 1-way, diverter 2/3/4/5 ways, wall outlet with support, handshower and flexible hose 1,70 m
 Встроенный душевой комплект на 2/3/4/5 выходов с настенным изливом, соединителем с держателем, ручным душем и душевым шлангом 1,70 м



43 622 /43 623 ●●●●●●●●●●

Conjunto termostático 2/3 vías con toma con soporte, ducha y flexo 1,70 m
 Concealed bath shower set with thermostatic mixer 2/3 ways, wall outlet with support, handshower and flexible hose 1,70 m
 Термостатический встроенный душевой комплект на 2/3 выхода с соединителем с держателем, ручным душем и душевым шлангом 1,70 м



43 651 ●●●●●●●●●●

Conjunto termostático ducha empotrado 1 vía con toma con soporte, ducha y flexo 1,70 m
 Concealed shower set with thermostatic mixer 1-way, wall outlet with support, handshower and flexible hose 1,70 m
 Термостатический встроенный душевой комплект на 1 выход с соединителем с держателем, ручным душем и душевым шлангом 1,70 м



43 652 /43 653 /43 654 /43 655 ●●●●●●●●●●

Conjunto termostático ducha empotrado 2/3/4/5 vías con toma con soporte, ducha y flexo 1,70 m
 Concealed shower set with thermostatic mixer 1-way, diverter 2/3/4/5 ways, wall outlet with support, handshower and flexible hose 1,70 m
 Термостатический встроенный душевой комплект на 2/3/4/5 выходов с соединителем с держателем, ручным душем и душевым шлангом 1,70 м



CONTEMPORARY

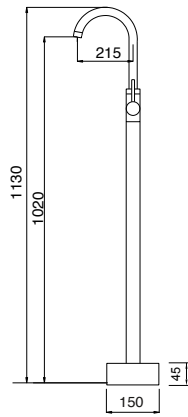

43 502 ●●●●●●●●●●
 Grifo exento lavabo 1130 mm redondo
 Floorstanding washbasin mixer 1130 mm round
 Mitigeur colonne lavabo 1130 mm rond
 Freistehende wasserhanmischer 1130 mm rund
 напольный смеситель для раковины 1130 мм круглый

43 504 ●●●●●●●●●●
 Grifo exento lavabo 1130 mm redondo con válvula click-clack
 Floorstanding washbasin mixer 1130 mm round with click-clack waste
 Mitigeur colonne lavabo 1130 mm rond avec vidage click-clack
 Freistehende wasserhanmischer 1130 mm rund mit click-clack ablaufgarnitur
 напольный смеситель для раковины 1130 мм круглый клик-клак клапаном

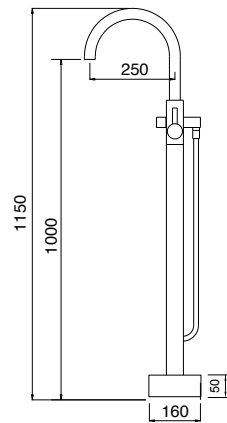

43 512 ●●●●●●●●●●
 Grifo exento baño ducha 1150 mm redondo con accesorios
 Floorstanding bath shower mixer 1150 mm round with accessories
 Mitigeur colonne bain/douche 1150 mm rond avec accessoires
 Freistehende wasserhanmischer bad/dusche 1150 mm rund mit zubehör
 напольный смеситель для ванны 1150 мм круглый с лейкой

CR
Cromo
Chrome

BL
Blanco mate
Matt white

NG
Negro mate
Matt black

CO
Cobre mate
Matt copper

BR
Bronce antiguo mate
Old matt bronze

NI
Níquel cepillado mate
Matt brushed nickel

O
Oro
Gold

OR
Oro Rosa
Rose Gold

OC
Oro cepillado
Brushed gold



42 Cylinder



Cylinder



La virtud circular. Es la simplicidad hecha belleza, la sublimación de la figura cilíndrica como elemento esencial y útil en el universo del baño. En mil y un acabados para las mil y una miradas.

The circular virtue. It is simplicity made beauty, the sublimation of the cylindrical figure as an essential and useful element in the bathroom universe. In a thousand finishes for a thousand different sights.



CR
Cromo
Chrome
Chrome
Chrom
Хром



NG
Negro mate
Matt black
Noir mate
Schwarz matte
Черное



BL
Blanco mate
Matt white
Blanche mate
Weisse matte
Белое



CO
Cobre mate
Matt copper
Cuiivre mat
Kupfer matt
Матовая медь



NI
Níquel cepillado mate
Matt brushed nickel
Matt brossé nickel
Matt gebürstetes Nickel
Брашированный матовый никель



O
Oro
Gold
Or
Gold
Золото



OR
Oro rosa
Rose gold
Or rosé
Rose Gold
Розовое золото



OC
Oro cepillado
Brushed gold
Or brossé
Gebürstetes gold
Брашированное золото

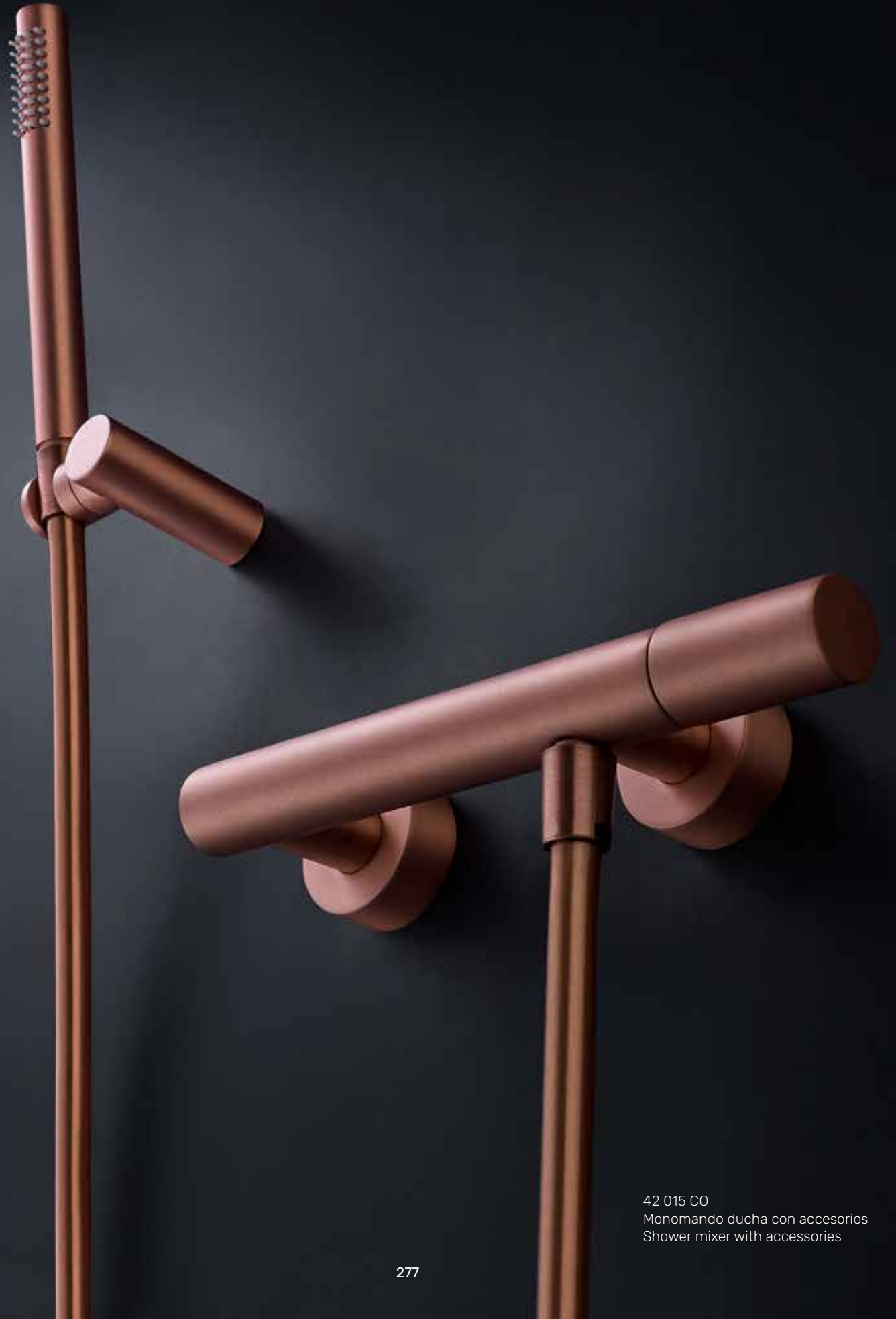

42 015 CO
Monomando ducha con accesorios
Shower mixer with accessories

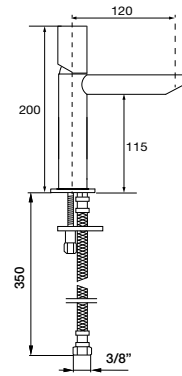

42 002 ●●●●●●●●●●

Monomando lavabo
Wash-basin mixer
Mitigeur lavabo
Einhebel waschtischmischer
Однорычажный Смеситель для раковины

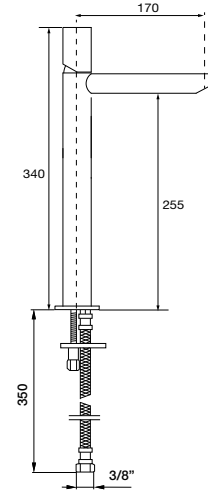

42 102 ●●●●●●●●●●

Monomando lavabo alto
High wash-basin mixer
Mitigeur lavabo haut
Einhebel waschtischmischer. Hohemn ausführung
Однорычажный Смеситель для раковин высокий

42 004 ●●●●●●●●●●

Monomando lavabo válv. desag. click-clack
Wash-basin mixer with click-clack waste
Mitigeur lavabo avec vidage click-clack
Einhebel waschtischmischer click-clack ablauf
Однорычажный смеситель для раковины с донным клапаном

42 104 ●●●●●●●●●●

Monomando lavabo alto válv. desag. click-clack
High wash-basin mixer with click-clack waste
Mitigeur lavabo haut avec vidage click-clack
Einhebel waschtischmischer. Hohemn ausführung mit click-clack ablauf
Однорычажный смеситель для раковины высокий с клапаном клик-клак

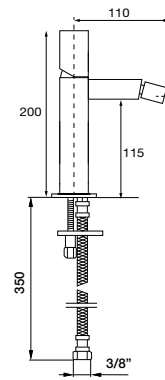

42 009 ●●●●●●●●●●

Monomando bidé
Bidet mixer
Mitigeur bidet
Einhebel bidetmischer
Однорычажный Смеситель для Биде

42 011 ●●●●●●●●●●

Monomando bidé válv. desag. click-clack
Bidet mixer with click-clack waste
Mitigeur bidet avec vidage click-clack
Einhebel bidetmischer click-clack ablauf
Однорычажный смеситель для биде с клапаном клик-клак



CR
Cromo
Chrome



BL
Blanco mate
Matt white



NG
Negro mate
Matt black



CO
Cobre mate
Matt copper



NI
Níquel cepillado mate
Matt brushed nickel



O
Oro
Gold



OR
Oro Rosa
Rose Gold



OC
Oro cepillado
Brushed gold



42 002 CR / CO / NI / BL / NG
Monomando lavabo
Wash-basin mixer

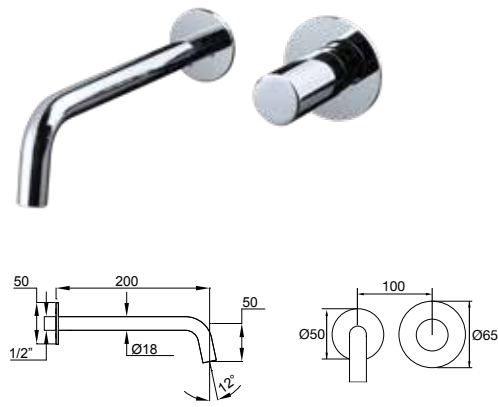

42 302 ●●●●●●●●●●

Monomando lavabo empotrado
Built-in single-lever wash-basin mixer
Mitigeur lavabo mural à encastrer
Unterputz Einhebel wannenmischer
Однорычажный смеситель для раковины настенный встроенный

42 304 ●●●●●●●●●●

Monomando lavabo empotrado válv. desag. click-clack
Built-in single-lever wash-basin with click-clack waste
Mitigeur lavabo mural à encastrer avec vidage click-clack
Unterputz Einhebel wannenmischer. click-clack ablauf
Однорычажный смеситель для раковины настенный встроенный с копаном клик-клак



42 702 ●●●●●●●●●●

Monomando lavabo repisa
Deck mounted single-lever wash basin mixer
Mitigeur de lavabo 2 trous sur gorge
Einhand Waschtischmischer 2-Loch
Однорычажный смеситель на столешницу / раковину

42 704 ●●●●●●●●●●

Monomando lavabo repisa válv. desag. click-clack
Deck mounted single-lever wash basin mixer with click-clack waste
Mitigeur de lavabo 2 trous sur gorge avec vidage click-clack
Einhand Waschtischmischer mit click-clack Ablaufgarnitur
Однорычажный смеситель на столешницу / раковину со сливом клик-клак



42 012 ●●●●●●●●●●

Monomando baño ducha con accesorios
Bath and shower mixer with accessories
Mitigeur bain-douche avec accessoires
Einhebel wannen und duschmischer
Смеситель ванна / душ настенного монтажа с аксессуарами



42 015 ●●●●●●●●●●

Monomando ducha con accesorios
Shower mixer with accessories
Mitigeur douche avec ensemble de douche
Einhebel duschmischer
Смеситель для душа настенного монтажа с аксессуарами



43 212 ●●●●●●●●●●

Batería termostática baño ducha con accesorios
Thermostatic bath shower with accessories
Mitigeur thermostatique bain-douche avec accessoires
Wannen und dusch thermostat batterie mit zuberhör
Смеситель термостат ванна / душ с аксессуарами

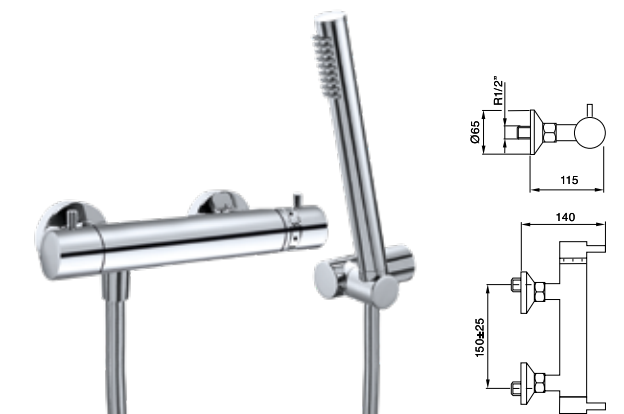

43 215 ●●●●●●●●●●

Batería termostática ducha con accesorios
Thermostatic shower with accessories
Thermostatique mitigeur douche avec accessoires
Dusch thermostat batterie mit zuberhör
Смеситель для душа с аксессуарами

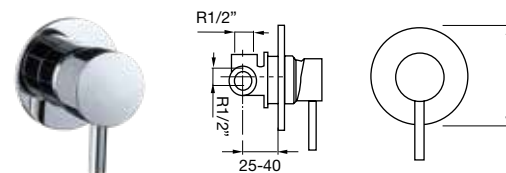

43 315 ●●●●●●●●●●

Monomando empotrar ducha
Built-in shower mixer
Ensemble douche à encastrer
Unterputz duschmischer
Встроенный смеситель на 1 выход

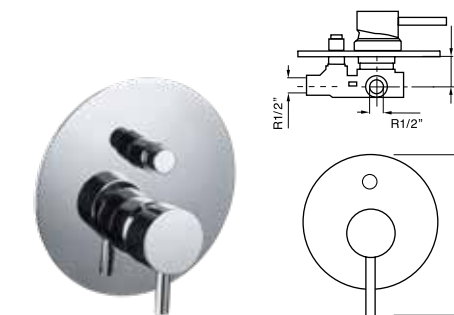

43 312 ●●●●●●●●●●

Monomando empotrar baño ducha
Built-in bath shower mixer
Mitigeur bain-douche à encastrer
Unterputz wannen und duschmischer
Однорычажный Смеситель встроенный ванна душ

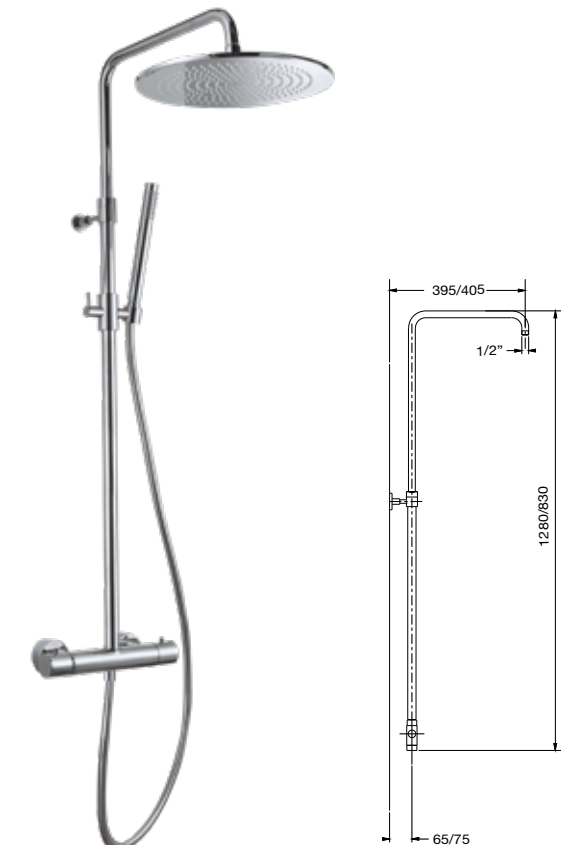

43 415 D300 ●●●●●●●●●●

Conjunto termostático con columna ducha cilíndrica telescópica y rociador D300
Thermostatic and round telescopic shower column unit with showerhead D300
Mitigeur thermostatique et barre de douche ronde télescopique avec pomme de douche D300
Thermostat brausegarnitur runde brausegarniture D300 bewegliche kopfbrause. Handbrause und brausehalter
Термостатический душевой комплект с колонной цилиндрической телескопической, с верхним душем D300



42 G1



G1



El grabado circular. Basada en la colección Cylinder, G1 es la evolución artística de su figura. De tacto singular y reflejo óptico sutil gracias a una bella trama dibujada en sus mandos.

The circular engraving. Based on Cylinder collection, G1 is the artistic evolution of his figure. Of singular touch and subtle optical reflection thanks to a beautiful texture on its handles.

- 

CR
Cromo
Chrome
Chrome
Chrom
Хром
- 

NG
Negro mate
Matt black
Noir mate
Schwarz matte
Черное
- 

O
Oro
Gold
Or
Gold
Золото
- 

OR
Oro rosa
Rose gold
Or rosé
Rose Gold
Розовое золото
- 

OC
Oro cepillado
Brushed gold
Or brossé
Gebürstetes gold
Брашированное золото



42 102 G1 O
Monomando lavabo alto
High wash-basin mixer

42 002 G1 OC
Monomando lavabo
Wash-basin mixer

MAIER

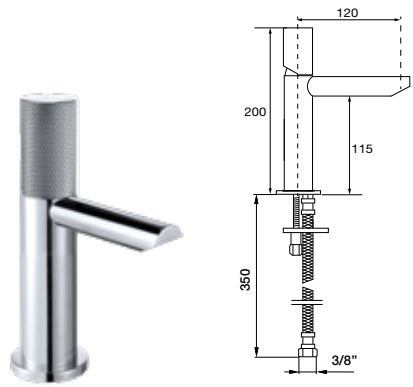

42 002 G1 ●●●●●

Monomando lavabo
Wash-basin mixer
Mitigeur lavabo
Einhebel waschtischmischer
Однорычажный Смеситель для раковины

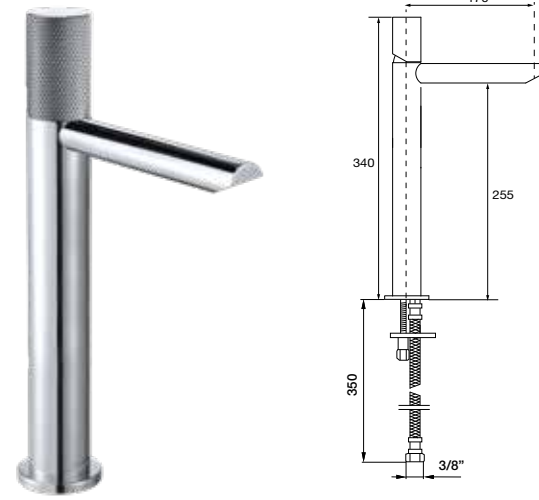

42 102 G1 ●●●●●

Monomando lavabo alto
High wash-basin mixer
Mitigeur lavabo haut
Einhebel waschtischmischer. Hohemn ausführung
Однорычажный Смеситель для раковин высокий

42 004 G1 ●●●●●

Monomando lavabo válv. desag. click-clack
Wash-basin mixer with click-clack waste
Mitigeur lavabo avec vidage click-clack
Einhebel waschtischmischer click-clack ablauf
Однорычажный смеситель для раковины с донным клапаном

42 104 G1 ●●●●●

Monomando lavabo alto válv. desag. click-clack
High wash-basin mixer with click-clack waste
Mitigeur lavabo haut avec vidage click-clack
Einhebel waschtischmischer. Hohemn ausführung mit click-clack ablauf
Однорычажный смеситель для раковины высокий с клапаном клик-клак

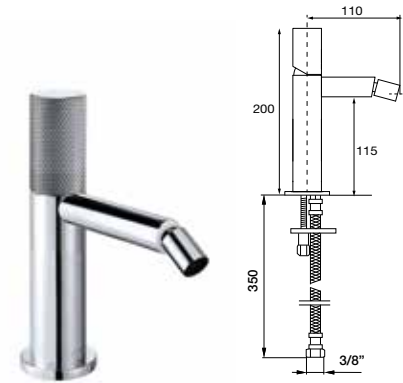

42 009 G1 ●●●●●

Monomando bidé
Bidet mixer
Mitigeur bidet
Einhebel bidetmischer
Однорычажный Смеситель для Биде

42 011 G1 ●●●●●

Monomando bidé válv. desag. click-clack
Bidet mixer with click-clack waste
Mitigeur bidet avec vidage click-clack
Einhebel bidetmischer click-clack ablauf
Однорычажный смеситель для иде с клапаном клик-клак

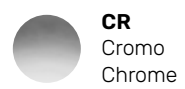

CR
Cromo
Chrome



NG
Negro mate
Matt black



O
Oro
Gold



OR
Oro Rosa
Rose Gold



OC
Oro cepillado
Brushed gold

42 G1



CONTEMPORARY

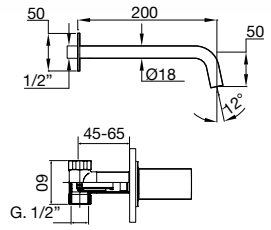

42 305 G1 ●●●●●

Bimando lavabo empotrado
Concealed 3 holes wash basin mixer
Mélangeur de lavabo 3 trous à encastrer
Unterputz 3-Loch Waschtischmischer
Встроенный смеситель для раковины на 3 отверстия

42 307 G1 ●●●●●

Bimando lavabo empotrado válv. desag. click-clack
Concealed 3 holes wash basin mixer with click-clack waste
Mélangeur de lavabo 3 trous à encastrer avec vidage click-clack
Unterputz 3-Loch Waschtischmischer mit click-clack Ablaufgarnitur
Встроенный смеситель для раковины на 3 отверстия со сливом клик-клак

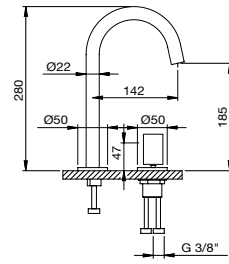

42 702 G1 ●●●●●

Monomando lavabo repisa
Deck mounted single-lever wash basin mixer
Mitigeur de lavabo 2 trous sur gorge
Einhand Waschtischmischer 2-Loch
Однорычажный смеситель на столешницу / раковину

42 704 G1 ●●●●●

Monomando lavabo repisa válv. desag. click-clack
Deck mounted single-lever wash basin mixer with click-clack waste
Mitigeur de lavabo 2 trous sur gorge avec vidage click-clack
Einhand Waschtischmischer mit click-clack Ablaufgarnitur
Однорычажный смеситель на столешницу / раковину со сливом клик-клак

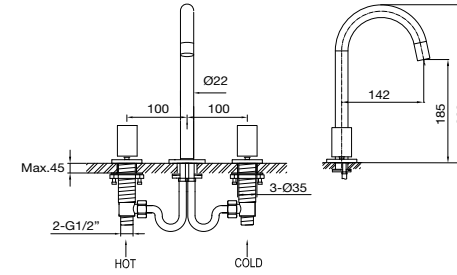

42 005J G1 ●●●●●

Juego lavabo caño central
Wash basin in 3 holes mixer
Mélangeur 3 trous pour lavabo
Waschtischmischer dreilochbatterie
Смеситель для раковины на 3 отверстия

42 075J G1 ●●●●●

Juego lavabo caño central válv. desag. click-clack
Wash basin in 3 holes mixer with click-clack waste
Batterie trois trous pour lavabo avec vidage click-clack
Waschtischmischer dreilochbatterie mit click-clack ablauf
Смеситель для раковины на 3 отверстия с клапаном клик-клак

42 G1

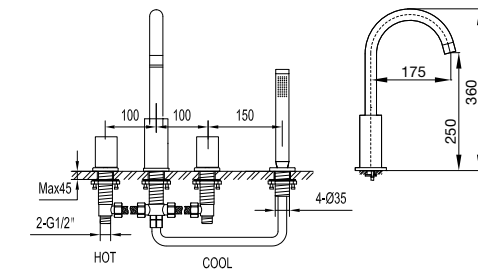

42 714J G1 ●●●●●

Grupo baño ducha 4 agujeros de repisa con ducha
Bath shower 4 holes mixer with handshower
Ensemble bain-douche 4 trous sur gorge avec ensemble de douche
Wannenrand bad und duschmischer
Смеситель на борт ванны для 4 отверстий с ручным душем

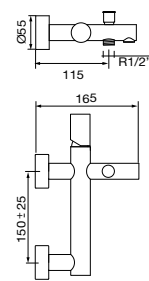

42 012 G1 ●●●●●

Monomando baño ducha con accesorios
Bath and shower mixer with accessories
Mitigeur bain-douche avec accessoires
Einhebel wannen und duschmischer
Смеситель ванна / душ настенного монтажа с аксессуарами

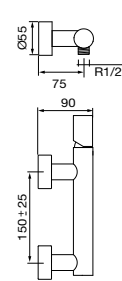

42 015 G1 ●●●●●

Monomando ducha con accesorios
Shower mixer with accessories
Mitigeur douche avec ensemble de douche
Einhebel duschmischer
Смеситель для душа настенного монтажа с аксессуарами

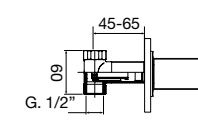

42 016 G1 ●●●●●

Llave de paso empotrar 1/2"
Built-in key step 1/2"
Robinet d'arrêt de 1/2"
Unterputz-ventil 1/2"
Кран встроенный 1/2"

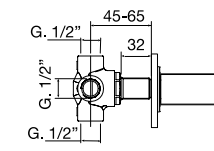
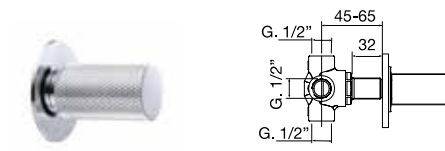

42 320 / 42 330 / 42 340 / 42 350 G1 ●●●●●

Distribuidor empotrar 2/3/4/5 salidas
Built-in diverter 2/3/4/5 ways
Inverseur 2/3/4/5 voies à encastrer
2/3/4/5-wege-umsteller
Встроенный дивертер на 2/3/4/5 выхода

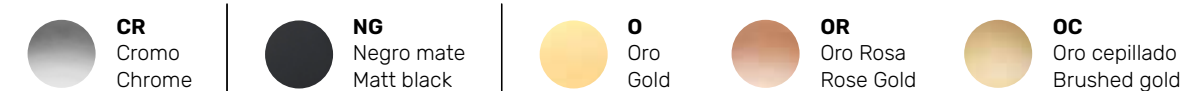

48 Kuadrat



CONTEMPORARY

Kuadrat



Geometría fluida. Un trampolín de líneas afiladas, y a la vez un grifo de mando firme. Kuadrat explota la geometría de los ángulos rectos para hacer del baño una estancia funcional y de diseño moderno.

Fluid Geometry. A springboard with sharp lines, and at the same time a firm control faucet. Kuadrat harness the geometry of right angles to turn the bathroom into a functional room with a modern design.



CR
Cromo
Chrome
Chrome
Chrom
Хром



NG
Negro mate
Matt black
Noir mate
Schwarz matte
Черное



CO
Cobre mate
Matt copper
Cuivre mat
Kupfer matt
Матовая медь



O
Oro
Gold
Or
Gold
Золото



OR
Oro rosa
Rose gold
Or rosé
Rose Gold
Розовое золото



OC
Oro cepillado
Brushed gold
Or brossé
Gebürstetes gold
Брашированное золото



48 002 NI
48 002 OC
Monomando lavabo
Wash-basin mixer





48 102 BL
Monomando lavabo alto
High wash-basin mixer

48 002 NG
Monomando lavabo
Wash-basin mixer

48 Kuadrat

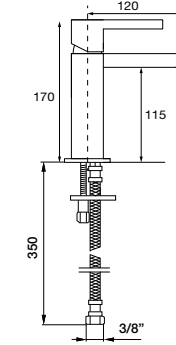

48 002 ●●●●●●

Monomando lavabo
Wash-basin mixer
Mitigeur lavabo
Einhebel waschtischmischer
Однорычажный Смеситель для раковины

48 004 ●●●●●●

Monomando lavabo válv. desag. click-clack
Wash-basin mixer with click-clack waste
Mitigeur lavabo avec vidage click-clack
Einhebel waschtischmischer click-clack ablauf
Однорычажный смеситель для раковины с донным клапаном

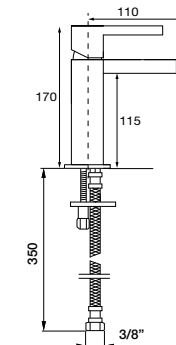

48 009 ●●●●●●

Monomando bidé
Bidet mixer
Mitigeur bidet
Einhebel bidetmischer
Однорычажный смеситель для биде

48 011 ●●●●●●

Monomando bidé válv. desag. click-clack
Bidet mixer with click-clack waste
Mitigeur bidet avec vidage click-clack
Einhebel bidetmischer click-clack ablauf
Однорычажный смеситель для биде с клапаном клик-клак



CR
Cromo
Chrome



NG
Negro mate
Matt black



CO
Cobre mate
Matt copper



O
Oro
Gold



OR
Oro Rosa
Rose Gold



OC
Oro cepillado
Brushed gold

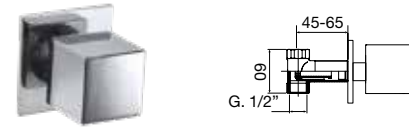
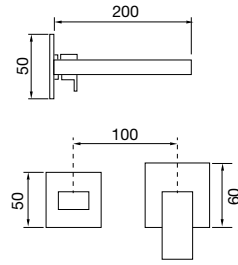

48 016 ●●●●●●

Llave de paso empotrar 1/2"
Built-in key step 1/2"
Robinet d'arrêt de 1/2"
Unterputz-ventil 1/2"
Кран встроенный 1/2"

48 302 ●●●●●●

Monomando lavabo empotrado
Built-in single-lever wash-basin mixer
Mitigeur lavabo mural à encastrer
Unterputz Einhebel wannenmischer
Однорычажный смеситель для раковины настенный встроенный

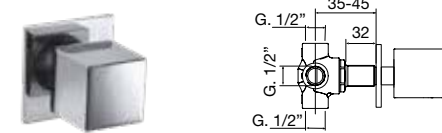

48 320 / 48 330 / 48 340 / 48 350 ●●●●●●

Distribuidor empotrar 2/3/4/5 salidas
Built-in diverter 2/3/4/5 ways
Inverseur 2/3/4/5 voies à encastrer
2/3/4/5-wege-umsteller
Встроенный дивертер на 2/3/4/5 выхода

48 304 ●●●●●●

Monomando lavabo empotrado válv. desag. click-clack
Built-in single-lever wash-basin with click-clack waste
Mitigeur lavabo mural à encastrer avec vidage click-clack
Unterputz Einhebel wannenmischer. Click-clack ablauf
Однорычажный смеситель для раковины настенный встроенный с копаном клик-клик

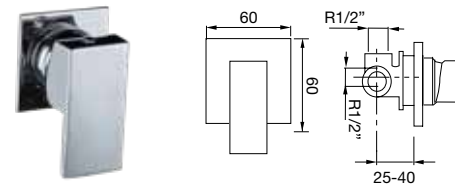
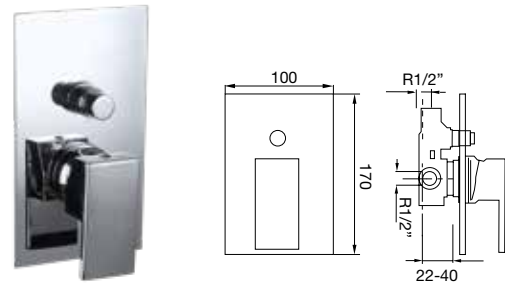

48 312 ●●●●●●

Monomando empotrar baño ducha
Built-in bath shower mixer
Mitigeur bain-douche à encastrer
Unterputz wannen und duschmischer
Однорычажный Смеситель встроенный ванна душ

48 315 ●●●●●●

Monomando empotrar ducha
Built-in shower mixer
Ensemble douche à encastrer
Unterputz duschmischer
Встроенный термостатический смеситель на 1 выход



CONTEMPORARY

48 012 CR
Monomando baño ducha con accesorios
Bath and shower mixer with accessories

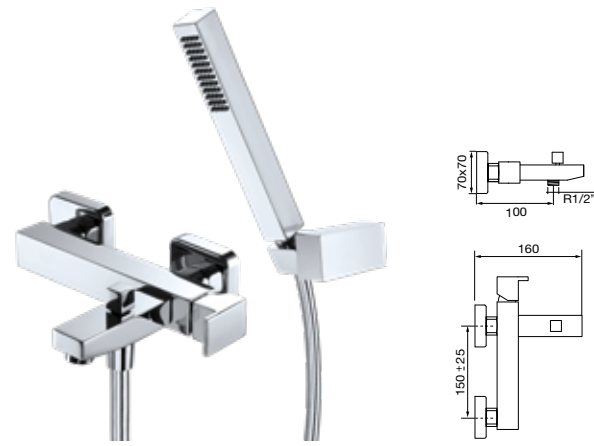

48 012

Monomando baño ducha con accesorios
Bath and shower mixer with accessories
Mitigeur bain-douche avec accessoires
Einhebel wannen und duschmischer
Смеситель ванна / душ настенного монтажа с аксессуарами

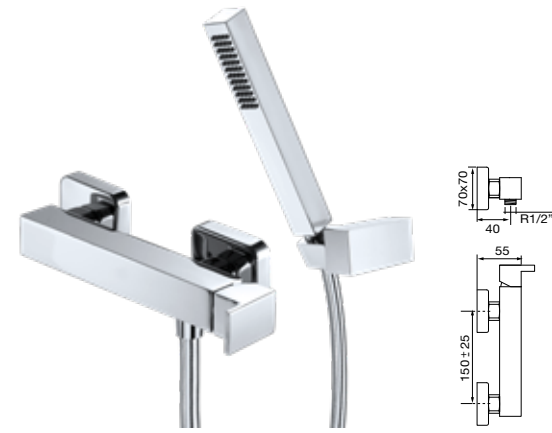

48 015

Monomando ducha con accesorios
Shower mixer with accessories
Mitigeur douche avec ensemble de douche
Einhebel duschmischer
Смеситель для душа настенного монтажа с аксессуарами



48 800

Monomando bidé empotrado con soporte, duchita y flexo 1,25 m
Concealed single-lever bidet set with support, shut-off handshower and flexible hose 1,25 m
Mitigeur de bidet à encastrer avec support, douchette et flexible 1,25 m
Unterputz Bidet Einhandmischer mit Handbrause und flexiblem Schlauch 1,25 m
Встроенный гигиенический душ с ручной лейкой и гибким шлангом 1,25 м.



48 212

Batería termostática baño ducha con accesorios
Thermostatic bath shower with accessories
Mitigeur thermostatique bain-douche avec accessoires
Wannen und dusch thermostat batterie mit zuberhör
Смеситель термостат ванна / душ с аксессуарами



48 215

Batería termostática ducha con accesorios
Thermostatic shower with accessories
Thermostatique mitigeur douche avec accessoires
Dusch thermostat batterie mit zuberhör
Смеситель душ с аксессуарами

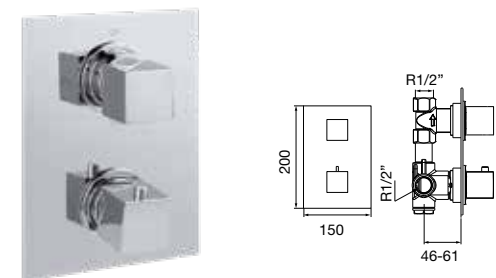

48 601 / 48 602 / 48 603

Termostático baño ducha empotrar con inversor 1/2/3 vías
Thermostatic concealed bath shower with diverter 1/2/3 ways
Mitigeur thermostatique bain/douche à encastrer avec inverseur 1/2/3 vois
Thermostat für brause/wannenbatterie mit umstellung 1/2/3 abgängen
термостатический Смеситель встроенный душ и ванна на 1/2/3 выхода

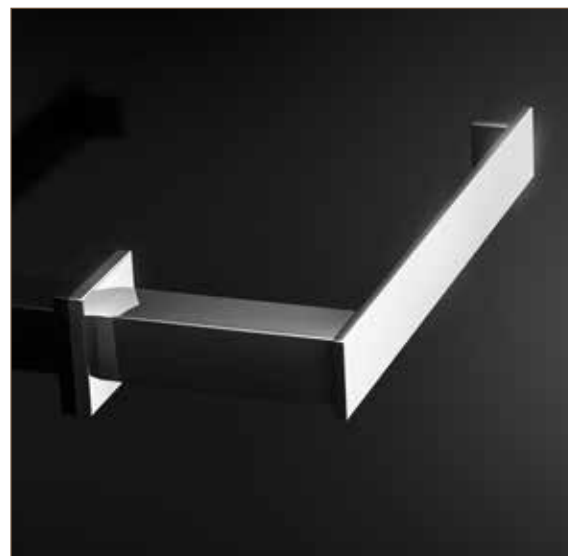

KUADRAT ACCESSORIES

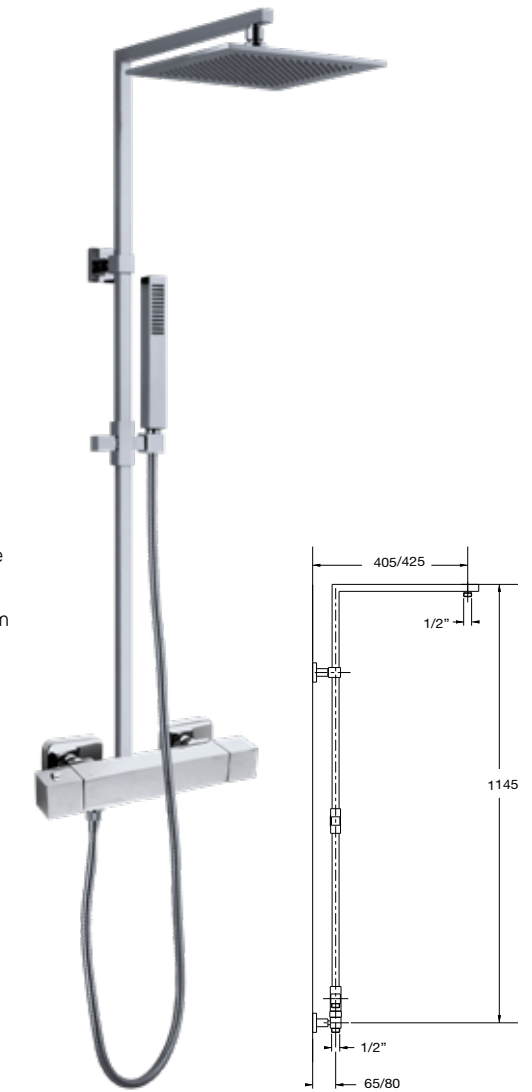

48 417-K200

Conjunto termostático con columna ducha cuadrada telescópica y rociador K200
Thermostatic and square telescopic shower column unit with showerhead K200
Mitigeur thermostatique et barre de douche carré télescopique avec pomme de douche K200
Thermostat brausegarnitur. Quadrat brausegarniture K200 bewegliche kopfbrause. Handbrause und brausehalter
Термостатический душевой комплект с колонной квадратной телескопической, с верхним душем K200

48 417-K300

Conjunto termostático con columna ducha cuadrada telescópica y rociador K300
Thermostatic and square telescopic shower column unit with showerhead K300
Mitigeur thermostatique et barre de douche carré télescopique avec pomme de douche K300
Thermostat brausegarnitur. Quadrat brausegarniture K300 bewegliche kopfbrause. Handbrause und brausehalter
Термостатический душевой комплект с колонной квадратной телескопической, с верхним душем K300

***48 413-K200 / K300**

Con grifo monomando
With single-lever mixer

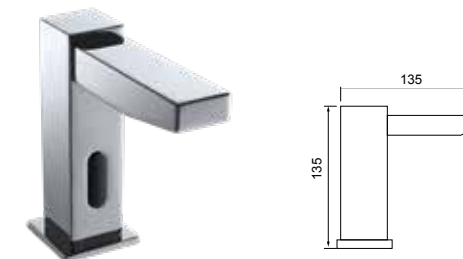

48 803

Grifo electrónico 1 agua
Sensor basin tap cold water
Robinet électronique sur plage 1 eau
Berührungslose elektronische waschtischarmatur
Смеситель с инфракрасным датчиком включения, только холодная вода

48 804

Grifo electrónico 2 aguas
Sensor basin tap cold and hot water
Robinet électronique sur plage froid et chaud
Berührungslose elektronische mischwaschtischarmatur
Смеситель с инфракрасным датчиком включения, холодная и горячая вода

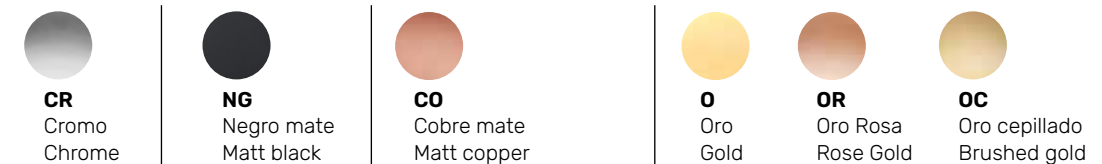

MAIER



48 317 ●●●●●●

Conjunto monomando ducha empotrado 1 vía con toma con soporte, ducha y flexo 1,70 m
 Concealed shower set with shower mixer 1-way, wall outlet with support, handshower and flexible hose 1,70 m
 Встроенный душевой комплект на 1 выход с соединителем с держателем, ручным душем и душевым шлангом 1,70 м



48 362 / 48 363 / 48 364 / 48 365 ●●●●●●

Conjunto bimando ducha empotrado 2/3/4/5 vías con toma con soporte, ducha y flexo 1,70 m
 Concealed bath shower set with two-handle shower keys, diverter 2/3/4/5 ways, wall outlet with support, handshower and flexible hose 1,70 m
 Встроенный душевой комплект на 4 отверстия на 2/3/4/5 выходов с соединителем с держателем, ручным душем и душевым шлангом 1,70 м



48 322 / 48 323 / 48 324 / 48 325 ●●●●●●

Conjunto monomando ducha empotrado 2/3/4/5 vías con toma con soporte, ducha y flexo 1,70 m
 Concealed shower set with shower mixer 1-way, diverter 2/3/4/5 ways, wall outlet with support, handshower and flexible hose 1,70 m
 Встроенный душевой комплект на 2/3/4/5 выходов с соединителем с держателем, ручным душем и душевым шлангом 1,70 м



48 316 ●●●●●●

Conjunto monomando 2 salidas con toma con soporte, ducha y flexo 1,70 m
 Concealed bath shower set with mixer 2-ways, wall outlet with support, handshower and flexible hose 1,70 m
 Встроенный душевой комплект однорычажный на 2 выхода с соединителем с держателем, ручным душем и душевым шлангом 1,70 м



48 314 ●●●●●●

Conjunto monomando baño ducha empotrado 2/3/4/5 vías con caño, toma con soporte, ducha y flexo 1,70 m
 Concealed bath shower set with shower mixer 1-way, diverter 2/3/4/5 ways, wall outlet with support, handshower and flexible hose 1,70 m
 Встроенный душевой комплект на 2/3/4/5 выходов с настенным изливом, соединителем с держателем, ручным душем и душевым шлангом 1,70 м



48 622 / 48 623 ●●●●●●

Conjunto termostático 2/3 vías con toma con soporte, ducha y flexo 1,70 m
 Concealed bath shower set with thermostatic mixer 2/3 ways, wall outlet with support, handshower and flexible hose 1,70 m
 Термостатический встроенный душевой комплект на 2/3 выхода с соединителем с держателем, ручным душем и душевым шлангом 1,70 м

48 Kuadrat



CONTEMPORARY

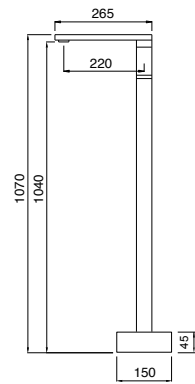

48 502 ●●●●●●

Grifo exento lavabo 1070 mm cuadrado
 Floorstanding wash-basin mixer 1070 mm square
 Mitigeur colonne lavabo 1070 mm carré
 Freistehende wasserhanmischer 1070 mm eckig
 Напольный смеситель для раковины 1070 мм квадратный

48 504 ●●●●●●

Grifo exento lavabo 1070 cuadrado con válvula click-clack
 Floorstanding wash-basin mixer 1070 mm square with click-clack waste
 Mitigeur colonne lavabo 1070 mm carré avec vidage click-clack
 Freistehende wasserhanmischer 1070 mm eckig mit click-clack ablaufgarnitur
 напольный смеситель для раковины 1070 мм квадратный клик-клак клапаном

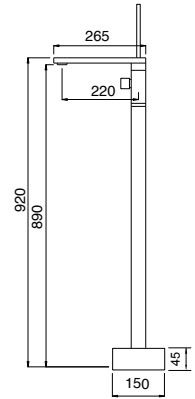

48 512 ●●●●●●

Grifo exento baño ducha 920 mm cuadrado con accesorios
 Floorstanding bath shower mixer 920 mm square with accessories
 Mitigeur colonne bain/douche 920 mm carré avec accessoires
 Freistehende wasserhanmischer bad/dusche 920 mm eckig mit zubehör
 Напольный смеситель для ванны 920 мм квадратный с лейкой

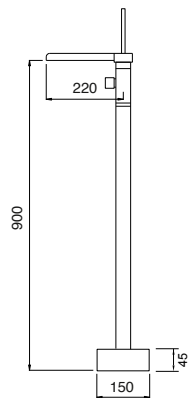

48 520 ●

Grifo exento baño ducha 900 mm cuadrado caño cascada con accesorios
 Floorstanding bath shower mixer 900 mm square cascade spout with accessories
 Mitigeur colonne bain/douche 900 mm carré bec cascade avec accessoires
 Freistehende wasserhanmischer bad/dusche 900 mm eckig mit kaskade und zubehör
 Напольный смеситель для ванны 900 мм квадратный с лейкой и изливом каскад



CR
Cromo
Chrome



NG
Negro mate
Matt black



CO
Cobre mate
Matt copper



O
Oro
Gold



OR
Oro Rosa
Rose Gold



OC
Oro cepillado
Brushed gold



48 520 CR
 Grifo exento baño ducha 900 mm cuadrado caño cascada con accesorios
 Floorstanding bath shower mixer 900 mm square cascade spout with accessories

49 Kub



CONTEMPORARY

Kub



El sólido perfecto. Una colección que juega con el agua desde la perfección cúbica. Kub es una apuesta sin pretensiones ni artificios por los grifos de diseño con aires de perfección y trascendencia.

The perfect solid. A collection that plays with water from cubic perfection. Kub is an unpretentious commitment to designer taps with an air of perfection and transcendence.



CR
Cromo
Chrome
Chrome
Chrom
Хром



NG
Negro mate
Matt black
Noir mate
Schwarz matte
Черное



CO
Cobre mate
Matt copper
Cuivre mat
Kupfer matt
Матовая медь



O
Oro
Gold
Or
Gold
Золото



OR
Oro rosa
Rose gold
Or rosé
Rose Gold
Розовое золото



OC
Oro cepillado
Brushed gold
Or brossé
Gebürstetes gold
Брашированное золото



49 015 NI
Monomando ducha con accesorios
Shower mixer with accessories

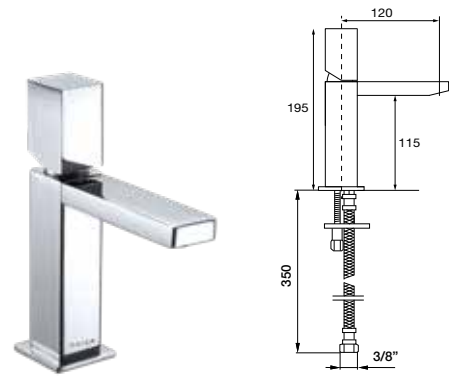

49 002 ●●●●●●●●

Monomando lavabo
Wash-basin mixer
Mitigeur lavabo
Einhebel waschtischmischer
Однорычажный Смеситель для раковины

49 004 ●●●●●●●●

Monomando lavabo válv. desag. click-clack
Wash-basin mixer with click-clack waste
Mitigeur lavabo avec vidage click-clack
Einhebel waschtischmischer click-clack ablauf
Однорычажный смеситель для раковины с донным клапаном

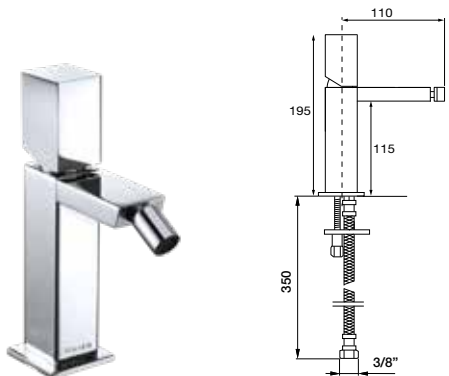

49 009 ●●●●●●●●

Monomando bidé
Bidet mixer
Mitigeur bidet
Einhebel bidetmischer
Однорычажный Смеситель для Биде

49 011 ●●●●●●●●

Monomando bidé válv. desag. click-clack
Bidet mixer with click-clack waste
Mitigeur bidet avec vidage click-clack
Einhebel bidetmischer click-clack ablauf
Однорычажный смеситель для иде с клапаном клик-клак

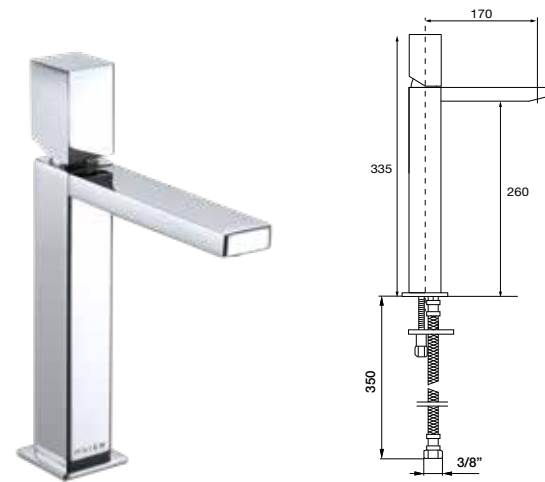

49 102 ●●●●●●●●

Monomando lavabo alto
High wash-basin mixer
Mitigeur lavabo haut
Einhebel waschtischmischer. Hohemn ausführung
Однорычажный Смеситель для раковин высокий

49 104 ●●●●●●●●

Monomando lavabo alto válv. desag. click-clack
High wash-basin mixer with click-clack waste
Mitigeur lavabo haut avec vidage click-clack
Einhebel waschtischmischer. Hohemn ausführung mit click-clack ablauf
Однорычажный смеситель для раковины высокий с клапаном клик-клак



49 305 ●●●●●●●●

Bimando lavabo empotrado
Concealed 3 holes wash basin mixer
Mélangeur de lavabo 3 trous à encastrer
Unterputz 3-Loch Waschtischmischer
Встроенный смеситель для раковины на 3 отверстия

49 307 ●●●●●●●●

Bimando lavabo empotrado válv. desag. click-clack
Concealed 3 holes wash basin mixer with click-clack waste
Mélangeur de lavabo 3 trous à encastrer avec vidage click-clack
Unterputz 3-Loch Waschtischmischer mit click-clack Ablaufgarnitur
Встроенный смеситель для раковины на 3 отверстия со сливом клик-клак

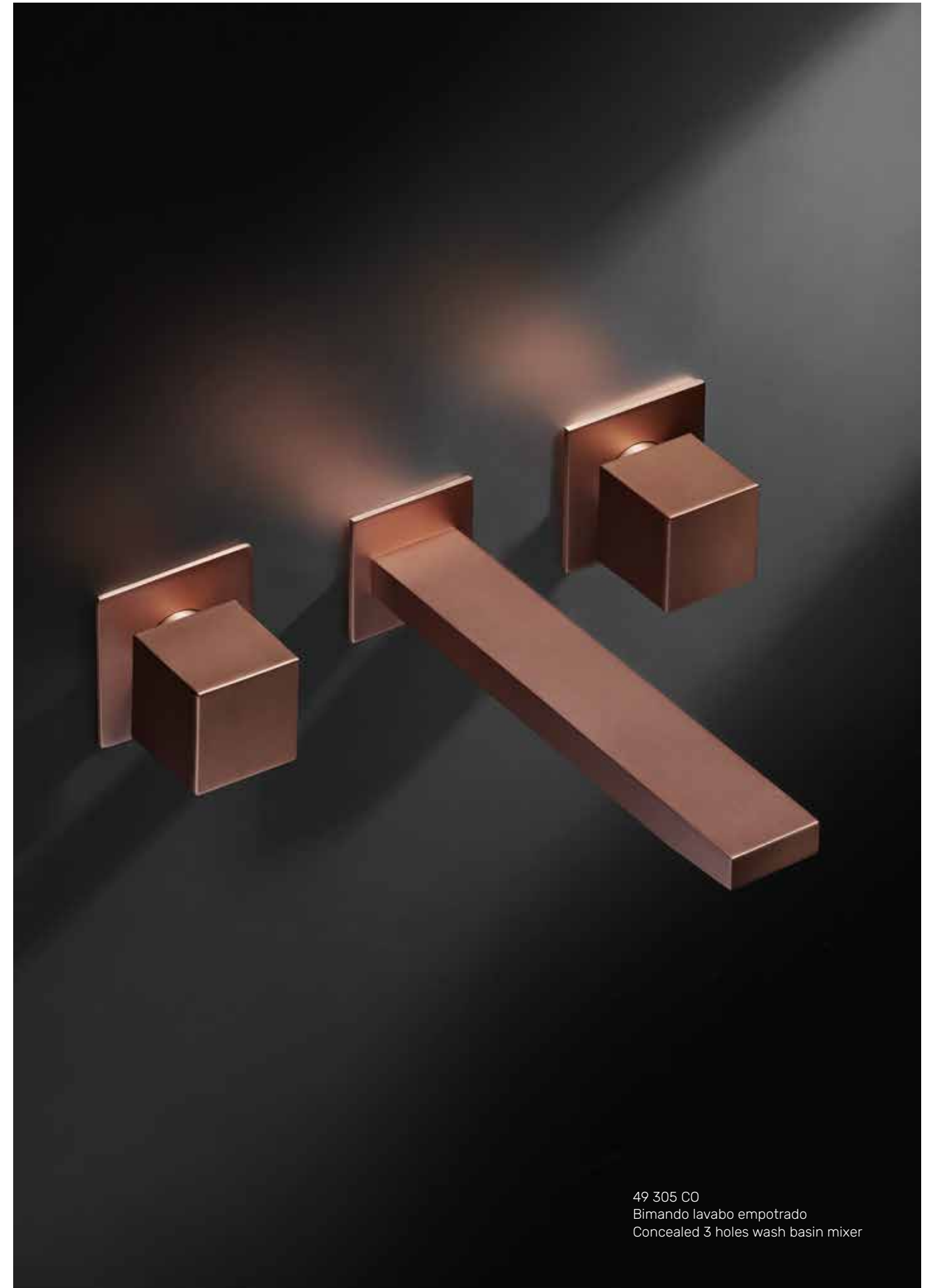

49 305 CO
Bimando lavabo empotrado
Concealed 3 holes wash basin mixer



49 012 ●●●●●●●●

Monomando baño ducha con accesorios
Bath and shower mixer with accessories
Mitigeur bain-douche avec accessoires
Einhebel wannen und duschmischer
Смеситель ванна / душ настенного монтажа с аксессуарами



49 015 ●●●●●●●●

Monomando ducha con accesorios
Shower mixer with accessories
Mitigeur douche avec ensemble de douche
Einhebel duschmischer
Смеситель для душа настенного монтажа с аксессуарами

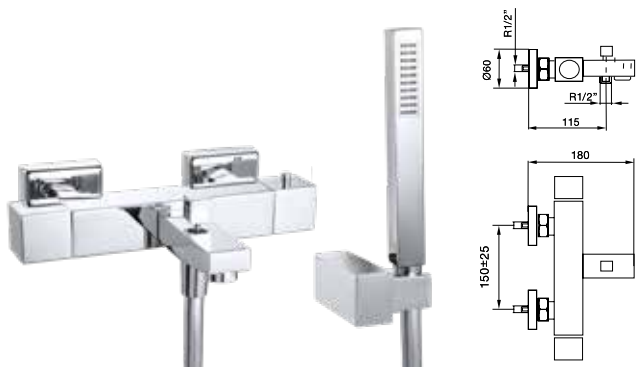

48 212 ●●●●●●●●

Batería termostática baño ducha con accesorios
Thermostatic bath shower with accessories
Mitigeur thermostatique bain-douche avec accessoires
Wannen und dusch thermostat batterie mit zuberhör
Смеситель термостат ванна / душ с аксессуарами



48 215 ●●●●●●●●

Batería termostática ducha con accesorios
Thermostatic shower with accessories
Mitigeur thermostatique mitigeur douche avec accessoires
Dusch thermostat batterie mit zuberhör
Смеситель термостатический душ с аксессуарами

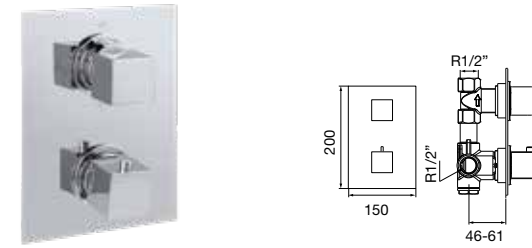

48 601 / 48 602 / 48 603 ●●●●●●●●

Termostático baño ducha empotrar con inversor 1/2/3 vías
Thermostatic concealed bath shower with diverter 1/2/3 ways
Mitigeur thermostatique bain/douche à encastrer avec inverseur 1/2/3 vois
Thermostat für brause/wannenbatterie mit umstellung 1/2/3 abgängen термостатический Смеситель встроенный душ и ванна на 1/2/3 выхода



48 016 ●●●●●●●●

Llave de paso empotrar 1/2\"
Built-in key step 1/2\"
Robinet d'arrêt de 1/2\"
Unterputz-ventil 1/2\"
Кран встроенный 1/2

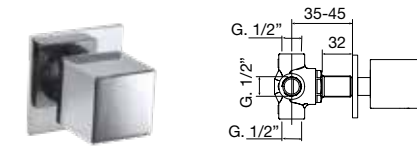

48 320 / 48 330 / 48 340 / 48 350 ●●●●●●●●

Distribuidor empotrar 2/3/4/5 salidas
Built-in diverter 2/3/4/5 ways
Inverseur 2/3/4/5 voies à encastrer
2/3/4/5-wege-umsteller
Встроенный дивертер на 2/3/4/5 выхода

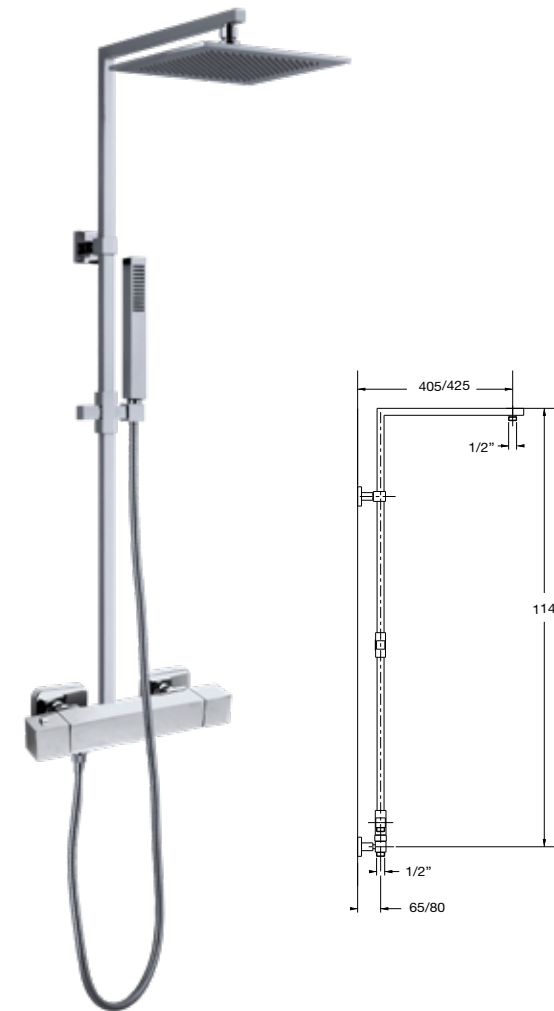

48 417 K200 ●●●●●●●●

Conjunto termostático con columna ducha cuadrada telescópica y rociador K200
Thermostatic and square telescopic shower column unit with showerhead K200
Mitigeur thermostatique et barre de douche carré télescopique avec pomme de douche K200
Thermostat brausegarnitur. Quadrat brausegarniture K200 bewegliche kopfbrause. Handbrause und brausehalter
Термостатический душевой комплект с колонной квадратной телескопической, с верхним душем K200

48 417 K300 ●●●●●●●●

Conjunto termostático con columna ducha cuadrada telescópica y rociador K300
Thermostatic and square telescopic shower column unit with showerhead K300
Mitigeur thermostatique et barre de douche carré télescopique avec pomme de douche K300
Thermostat brausegarnitur. Quadrat brausegarniture K300 bewegliche kopfbrause. Handbrause und brausehalter
Термостатический душевой комплект с колонной квадратной телескопической, с верхним душем K300

***48 413-K200 / K300** ●●●●●●●●

Con grifo monomando
With single-lever mixer

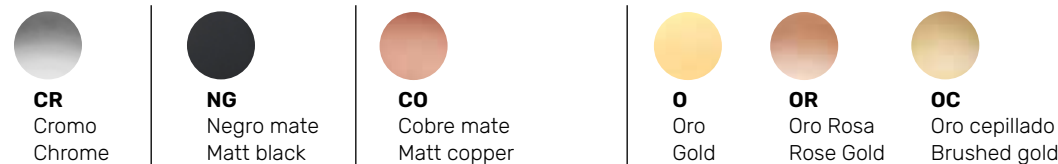

40 Maxima



Maxima



Largo camino a la precisión. Cruza los dedos para conseguir un grifo tan exacto como la colección Maxima. Una colección que aporta el justo equilibrio en la producción de agua y una estética elemental.

Long road to accuracy. Cross your fingers for achieving a faucet as exact as the Maxima collection. A collection that provides the right balance between the water flow and an elemental aesthetic.

- | | | |
|--|---|---|
| <p>CR
Cromo
Chrome
Chrom
Хром</p> | <p>NG
Negro mate
Matt black
Noir mate
Schwarz matte
Черное</p> | <p>O
Oro
Gold
Or
Gold
Золото</p> |
|--|---|---|



40 002 NG
Monobloc lavabo
Single-hole wash-basin mixer

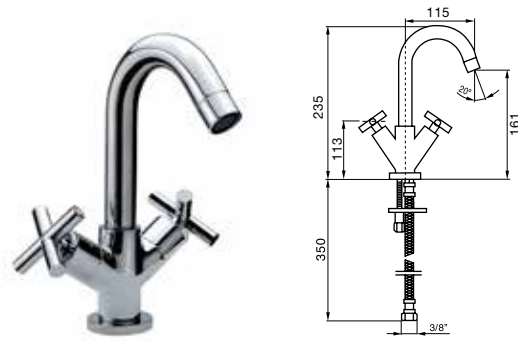

40 002 ●●●●

Monobloc lavabo
Single-hole wash-basin mixer
Mélangeur lavabo monotrou
1-loch-zweigriff-waschtischbatterie
Смеситель для раковины

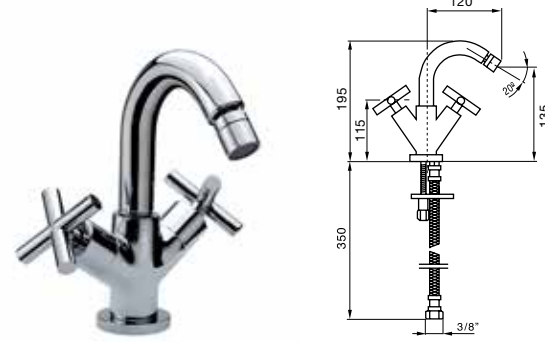

40 009 ●●●●

Monobloc bidé
Single-hole bidet
Mélangeur bidet
Bidetbatterie
Смеситель для Биде



40 012 ●●●●

Grupo baño ducha con accesorios
Wall mounted bath shower mixer with accessories
Mélangeur bain-douche avec accessoires
Wannen und dusch batterie mit zuberhör
Смеситель ванна / душ настенного монтажа с аксессуарами

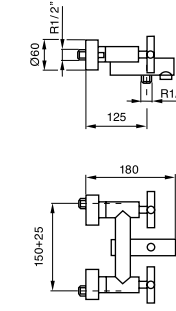

40 015 ●●●●

Grupo ducha con accesorios
Shower mixer with accessories
Mélangeur douche avec ensemble de douche
Dusch batterie mit zuberhör
Смеситель для душа настенного монтажа с аксессуарами

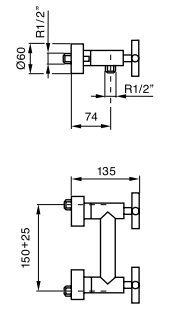

40 004 ●●●●

Monobloc lavabo válv. desag. click-clack
Single-hole wash-basin set with click-clack waste
Mélangeur lavabo avec vidage click-clack
Waschtischbatterie. Click-clack ablauf
Смеситель для раковины с клапаном клик-клак

40 011 ●●●●

Monobloc bidé válv. desag. click-clack
Single-hole bidet set with click-clack waste
Mélangeur bidet avec vidage click-clack
Bidetbatterie. Click-clack ablauf
Смеситель для биде с клапаном клик-клак

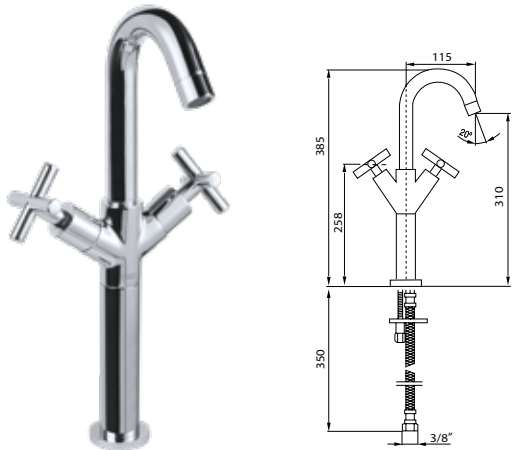

40 102 ●●●●

Monobloc lavabo alto
Single-hole high wash-basin
Mélangeur lavabo haut monotrou
1-loch-zweigriff-waschtischbatterie hoher
Высокий смеситель для раковины



40 305 ●●●●

Bimando lavabo empotrado
Concealed 3 holes wash basin mixer
Mélangeur de lavabo 3 trous à encastrer
Unterputz 3-Loch Waschtischmischer
Встроенный смеситель для раковины на 3 отверстия



40 003 ●●●●

Monomando lavabo
Wash-basin mixer
Mitigeur lavabo
Einhebel waschtischmischer
Однорычажный Смеситель для раковины

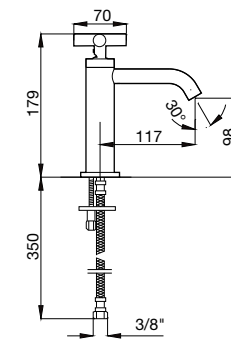

40 005J ●●●●

Juego lavabo caño central
Wash basin in 3 holes mixer
Mélangeur 3 trous pour lavabo
Waschtischmischer dreilochbatterie
Смеситель для раковины на 3 отверстия

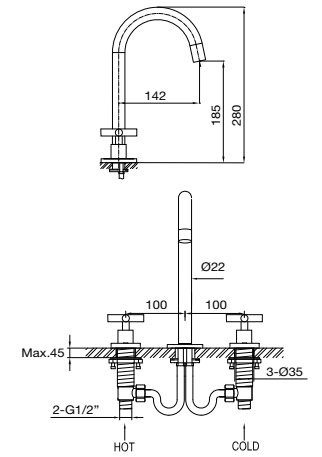

40 104 ●●●●

Monobloc lavabo alto válv. desag. click-clack
Single-hole high wash-basin set with click-clack waste
Mélangeur lavabo haut monotrou avec vidage click-clack
1-loch-zweigriff-waschtischbatterie hoher mit click-clack ablauf
Высокий смеситель для раковины с клапаном клик-клак

40 307 ●●●●

Bimando lavabo empotrado válv. desag. click-clack
Concealed 3 holes wash basin mixer with click-clack waste
Mélangeur de lavabo 3 trous à encastrer avec vidage click-clack
Unterputz 3-Loch Waschtischmischer mit click-clack Ablaufgarnitur
Встроенный смеситель для раковины на 3 отверстия со сливом клик-клак

40 007 ●●●●

Monomando lavabo válv. desag. click-clack
Wash-basin mixer with click-clack waste
Mitigeur lavabo avec vidage click-clack
Einhebel waschtischmischer click-clack ablauf
Однорычажный смеситель для раковины с донным клапаном

40 075J ●●●●

Juego lavabo caño central válv. desag. click-clack
Wash basin in 3 holes mixer with click-clack waste
Batterie trois trous pour lavabo avec vidage click-clack
Waschtischmischer dreilochbatterie mit click-clack ablauf
Смеситель для раковины на 3 отверстия с клапаном клик-клак

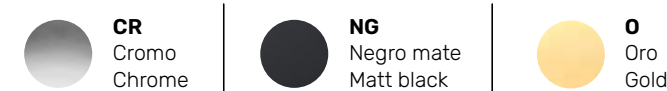

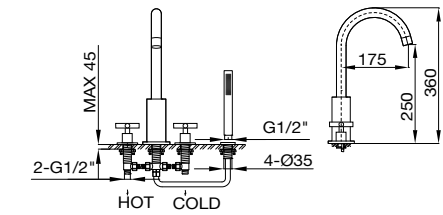

40 714J ●●●

Grupo baño ducha 4 agujeros de repisa con ducha
 Bath shower 4 holes mixer with handshower
 Ensemble bain-douche 4 trous sur gorge avec ensemble de douche
 Wannenrand bad und duschmischer
 Смеситель на борт ванны для 4 отверстий с ручным душем



40 016 ●●●

Llave de paso empotrar 1/2"
 Built-in key step 1/2"
 Robinet d'arrêt de 1/2"
 Unterputz-ventil 1/2"
 Кран встроенный 1/2"

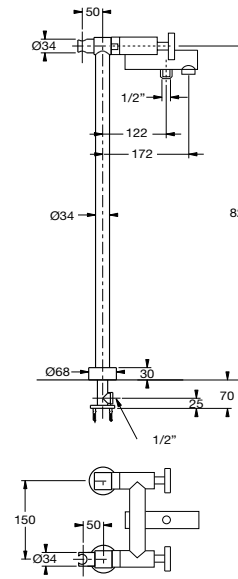

40 320 / 40 330 / 40 340 / 40 350 ●●●

Distribuidor empotrar 2/3/4/5 salidas
 Built-in diverter 2/3/4/5 ways
 Inverseur 2/3/4/5 voies à encastrer
 2/3/4/5-Wege-umsteller
 Встроенный дивертер на 2/3/4/5 выхода

40 512 ●●●

Grupo baño ducha con columnas suelo de 820 mm
 Bath shower group with floor-standing columns of 820 mm
 Mélangeur bain-douche sur colonnes de 820 mm
 Wannen batterie mit 820 mm hohen boden anschluss, handbrause und flexiblen schlauch
 Смеситель ванна / душ с напольными колоннами 820 mm

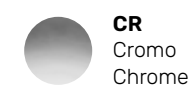

CR
 Cromo
 Chrome

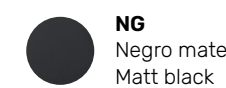

NG
 Negro mate
 Matt black



O
 Oro
 Gold

58 Skip



Skip



La armonía de la curva. Un diseño sensual dibujado con pulso firme. La frescura de sus líneas. La belleza de lo sobrio. Los elementos que distinguen una colección que desprende magia discretamente.

The harmony of the curve. A sensual design drawn with steady pulse. The freshness of its shapes. The beauty of the sober. The elements that distinguish a collection which discreetly detaches magic.



CR
Cromo
Chrome
Chrome
Chrom
Хром



NG
Negro mate
Matt black
Noir mate
Schwarz matte
Черное



O
Oro
Gold
Or
Gold
Золото



OC
Oro cepillado
Brushed gold
Or brossé
Gebürstetes gold
Брашированное золото



58 002 CR
Monomando lavabo
Wash-basin mixer



58 015 CR
Monomando ducha con accesorios
Shower mixer with accessories

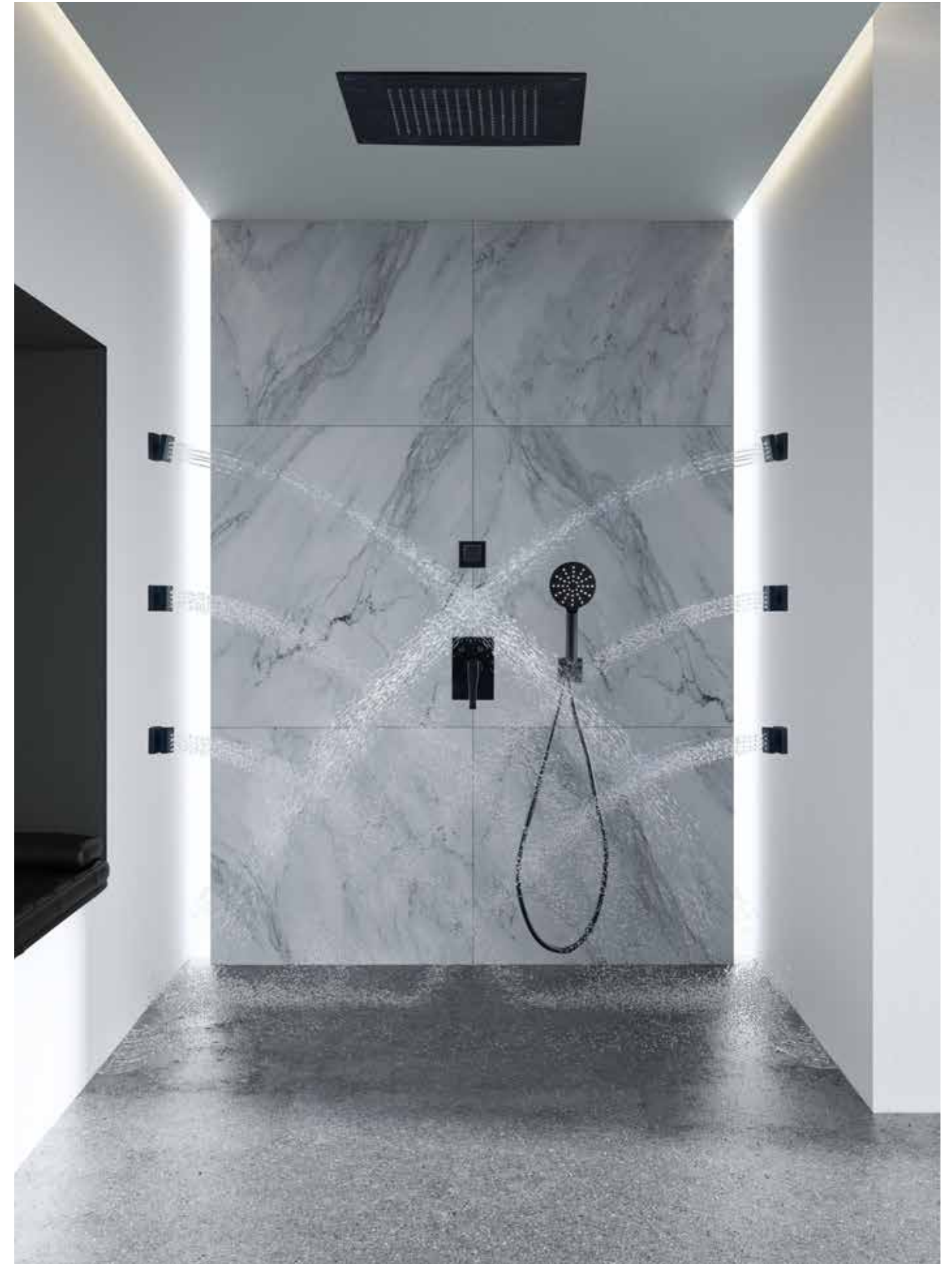

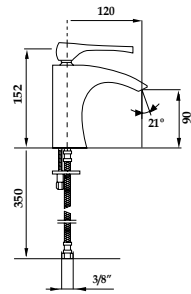

58 002 ●●●●

Monomando lavabo
Wash-basin mixer
Mitigeur lavabo
Einhebel waschtischmischer
Однорычажный Смеситель для раковины

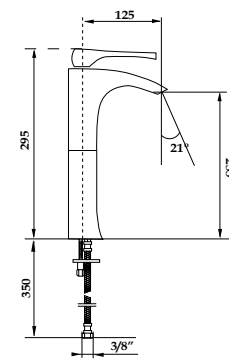

58 102 ●●●●

Monomando lavabo alto
High wash-basin mixer
Mitigeur lavabo haut
Einhebel waschtischmischer. Hohemn ausführung
Однорычажный Смеситель для раковин высокий

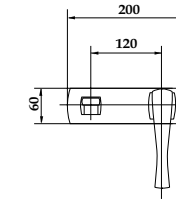
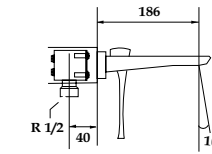

58 302 ●●●●

Monomando lavabo empotrado
Built-in single-lever wash-basin mixer
Mitigeur lavabo mural à encastrer
Unterputz Einhebel wannenmischer
Однорычажный смеситель для раковины настенный встроенный

58 004 ●●●●

Monomando lavabo válv. desag. click-clack
Wash-basin mixer with click-clack waste
Mitigeur lavabo avec vidage click-clack
Einhebel waschtischmischer click-clack ablauf
Однорычажный смеситель для раковины с клапаном клик-клак

58 104 ●●●●

Monomando lavabo alto válv. desag. click-clack
High wash-basin mixer with click-clack waste
Mitigeur lavabo haut avec vidage click-clack
Einhebel waschtischmischer. Hohemn ausführung mit click-clack ablauf
Однорычажный смеситель для раковины высокий с клапаном клик-клак

58 304 ●●●●

Monomando lavabo empotrado válv. desag. click-clack
Built-in single-lever wash-basin with click-clack waste
Mitigeur lavabo mural à encastrer avec vidage click-clack
Unterputz Einhebel wannenmischer. Click-clack ablauf
Клапаном клик-клак

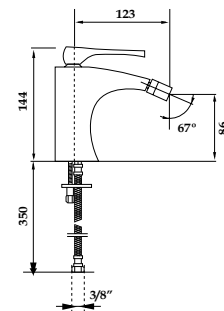

58 009 ●●●●

Monomando bidé
Bidet mixer
Mitigeur bidet
Einhebel bidetmischer
Однорычажный смеситель для биде

58 011 ●●●●

Monomando bidé válv. desag. click-clack
Bidet mixer with click-clack waste
Mitigeur bidet avec vidage click-clack
Einhebel bidetmischer click-clack ablauf
Однорычажный смеситель для биде с клапаном клик-клак

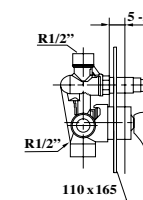

58 312 ●●●●

Monomando empotrar baño ducha
Built-in bath shower mixer
Mitigeur bain-douche à encastrer
Unterputz wannen und duschmischer
Однорычажный Смеситель встроенный ванна душа

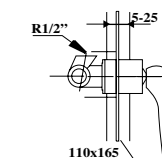

58 315 ●●●●

Monomando empotrar ducha
Built-in shower mixer
Ensemble douche à encastrer
Unterputz duschmischer
Однорычажный Смеситель встроенный для душа

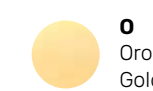
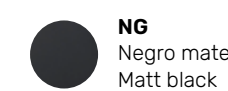
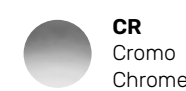



58 012 CR
Monomando baño ducha con accesorios
Bath and shower mixer with accessories



58 002 CR
Monomando lavabo
Wash-basin mixer

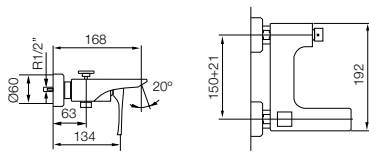

58 012 ●●●●●

Monomando baño ducha con accesorios
Bath and shower mixer with accessories
Mitigeur bain-douche avec accessoires
Einhebel wannen und duschmischer
Смеситель ванна / душ настенного монтажа с аксессуарами

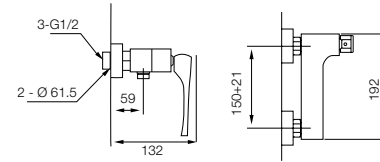

58 015 ●●●●●

Monomando ducha con accesorios
Shower mixer with accessories
Mitigeur douche avec ensemble de douche
Einhebel duschmischer
Смеситель для душа настенного монтажа с аксессуарами

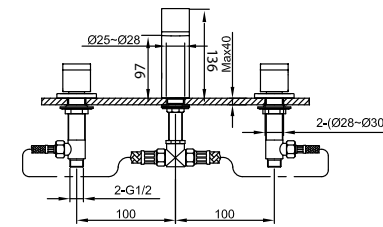

58 005 ●●●●●

Juego lavabo caño central
Wash basin in 3 holes mixer
Mélangeur 3 trous pour lavabo
Waschtischmischer dreilochbatterie
Смеситель для раковины на 3 отверстия

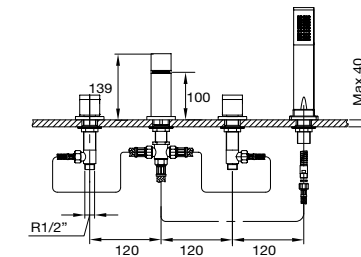

58 714 ●●●●●

Grupo baño ducha 4 agujeros de repisa con ducha
Bath shower 4 holes mixer with handshower
Ensemble bain-douche 4 trous sur gorge avec ensemble de douche
Wannenrand bad und duschmischer
Смеситель на борту ванны для 4 отверстий с ручным душем



58 321 ●●●●●

Conjunto monomando empotrado de latón con duchita y flexo 1,25m
Set single-lever concealed brass mixer with handspray and flexible hose 1,25 m
Ensemble mitigeur a encastrer laiton avec douchette et connexion flexible 1,25 m
Set messing unterputz-mischer mit handbrause und 1,25 m flexiblen schlauch
Встроенный смеситель с гигиеническим душем, шланг 1,25 m

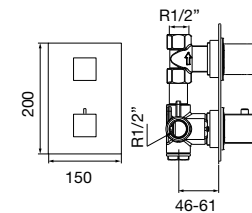

58 601 / 58 602 / 58 603 ●●●●●

Termostático baño ducha empotrar con inversor 1/2/3 vías
Thermostatic concealed bath shower with diverter 1/2/3 ways
Mitigeur thermostatique bain/douche à encastrer avec inverseur 1/2/3 voies
Thermostat für brause/wannenbatterie mit umstellung 1/2/3 abgängen
Термостатический смеситель встроенный душ и ванна на 1/2/3 выхода



58 016 ●●●●●

Llave de paso empotrar 1/2"
Built-in key step 1/2"
Robinet d'arrêt de 1/2"
Unterputz-ventil 1/2"
Кран встроенный 1/2"

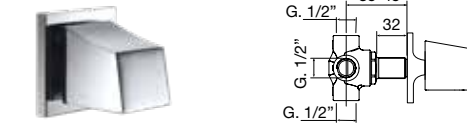

58 320 / 58 330 / 58 340 / 58 350 ●●●●●

Distribuidor empotrar 2/3/4/5 salidas
Built-in diverter 2/3/4/5 ways
Inverseur 2/3/4/5 voies a encastrer
2/3/4/5-wege-umsteller
Встроенный дивертер на 2/3/4/5 выхода

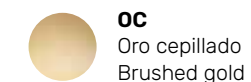
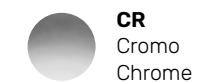

66 Muse



68 Chik



Muse



Chik



Minimalismo musical. Es difícil imaginar un grifo tan elegante con menos elementos. Un dispensador de agua que prima la perfección de las líneas y la sencillez mientras suena con notas de vanguardia.

Musical minimalism. It is hard to imagine a faucet as stylish with fewer elements. A water device that highlight the perfection of lines and simplicity while sounds with vanguards notes.

La isla mínima. Formas ergonómicas perfectas, simplicidad sublime. Un diseño apto para espacios distinguidos y salas de baño modernas y con encanto.

The minimal island. Perfect ergonomic shapes, sublime simplicity. A design suitable for distinguished spaces and modern bathrooms with charm.

CR
Cromo
Chrome
Chrom
Хром

O
Oro
Gold
Or
Gold
Золото

OR
Oro rosa
Rose gold
Or rosé
Rose Gold
Розовое золото

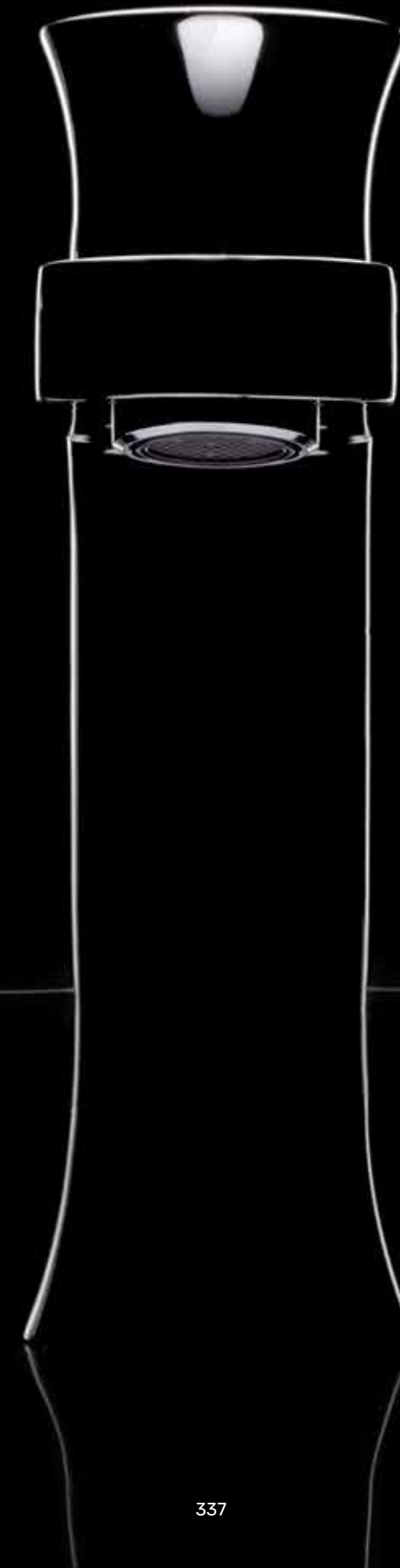

Muse

66 002 CR
Monomando lavabo
Wash-basin mixer



66 002 ●●●
68 002 ●●●

Monomando lavabo
Wash-basin mixer
Mitigeur lavabo
Einhebel waschtischmischer
Однорычажный Смеситель для раковины

66 102 ●●●
68 102 ●●●

Monomando lavabo alto
High wash-basin mixer
Mitigeur lavabo haut
Einhebel waschtischmischer. Hohemn ausführung
Однорычажный Смеситель для раковин высокий

66 004 ●●●
68 004 ●●●

Monomando lavabo válv. desag. click-clack
Wash-basin mixer with click-clack waste
Mitigeur lavabo avec vidage click-clack
Einhebel waschtischmischer click-clack ablauf
Однорычажный смеситель для раковины с донным клапаном

66 104 ●●●
68 104 ●●●

Monomando lavabo alto válv. desag. click-clack
High wash-basin mixer with click-clack waste
Mitigeur lavabo haut avec vidage click-clack
Einhebel waschtischmischer. Hohemn ausführung mit click-clack ablauf
Однорычажный смеситель для раковины высокий с клапаном клик-клак



66 302 ●●●
68 302 ●●●

Monomando lavabo empotrado
Built-in single-lever wash-basin mixer
Mitigeur lavabo mural à encastrer
Unterputz Einhebel wannenmischer
Однорычажный смеситель для раковины настенный встроенный

66 304 ●●●
68 304 ●●●

Monomando lavabo empotrado válv. desag. click-clack
Built-in single-lever wash-basin with click-clack waste
Mitigeur lavabo mural à encastrer avec vidage click-clack
Unterputz Einhebel wannenmischer. Click-clack ablauf
С клапаном клик-клак



66 009 ●●●
68 009 ●●●

Monomando bidé
Bidet mixer
Mitigeur bidet
Einhebel bidetmischer
Однорычажный смеситель для биде

66 011 ●●●
68 011 ●●●

Monomando bidé válv. desag. click-clack
Bidet mixer with click-clack waste
Mitigeur bidet avec vidage click-clack
Einhebel bidetmischer click-clack ablauf
Однорычажный смеситель для биде с клапаном клик-клак

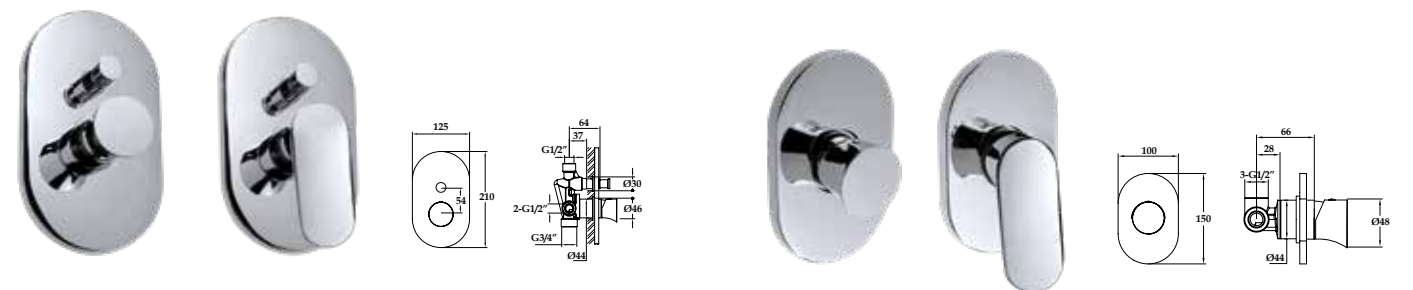

66 312 ●●●
68 312 ●●●

Monomando empotrar baño ducha
Built-in bath shower mixer
Mitigeur bain-douche à encastrer
Unterputz wannen und duschmischer
Однорычажный Смеситель встроенный ванна душ

66 315 ●●●
68 315 ●●●

Monomando empotrar ducha
Built-in shower mixer
Ensemble douche à encastrer
Unterputz duschmischer
Однорычажный Смеситель встроенный для душа

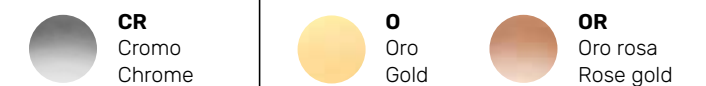



Chik

68 012 CR
Monomando baño ducha con accesorios
Bath and shower mixer with accessories

66 Muse / 68 Chik

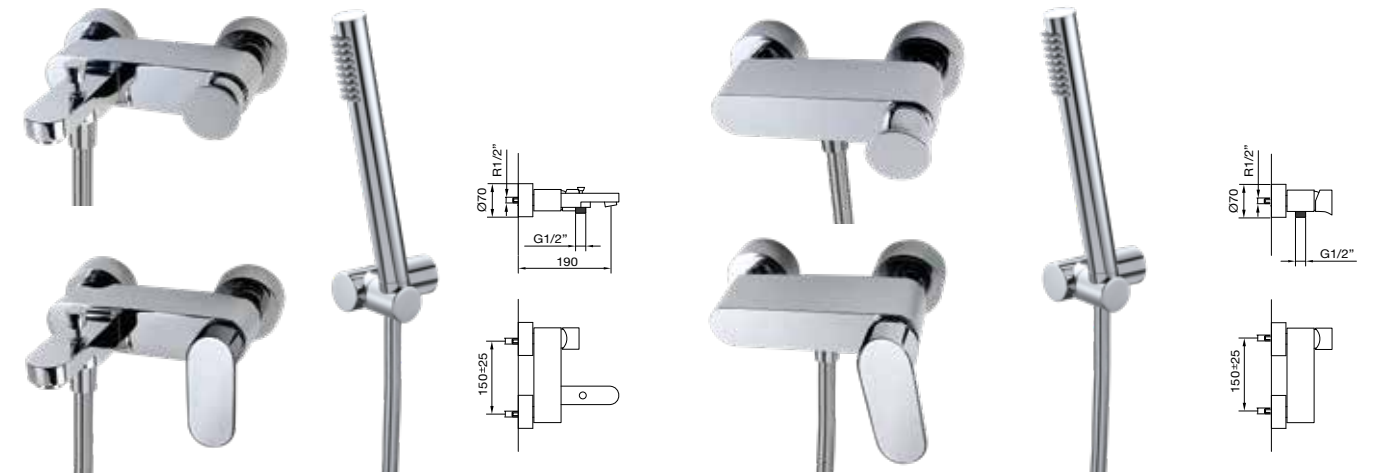

66 012 ●●●●
68 012 ●●●●

Monomando baño ducha con accesorios
Bath and shower mixer with accessories
Mitigeur bain-douche avec accessoires
Einhebel wannen und duschmischer
Смеситель ванна / душ настенного монтажа с аксессуарами

66 015 ●●●●
68 015 ●●●●

Monomando ducha con accesorios
Shower mixer with accessories
Mitigeur douche avec ensemble de douche
Einhebel duschmischer
Смеситель для душа настенного монтажа с аксессуарами



66 512 ●●●●
68 512 ●●●●

Grupo baño ducha con columnas suelo de 820 mm
Bath shower group with floor-standing columns of 820 mm
Mitigeur bain-douche sur colonnes de 820 mm
Wannen batterie mit 820 mm hohen boden anschluss, handbrause und flexiblen schlauch
Смеситель ванна / душ с напольными колоннами 820 мм

● **CR**
Cromo
Chrome

● **O**
Oro
Gold

● **OR**
Oro rosa
Rose gold

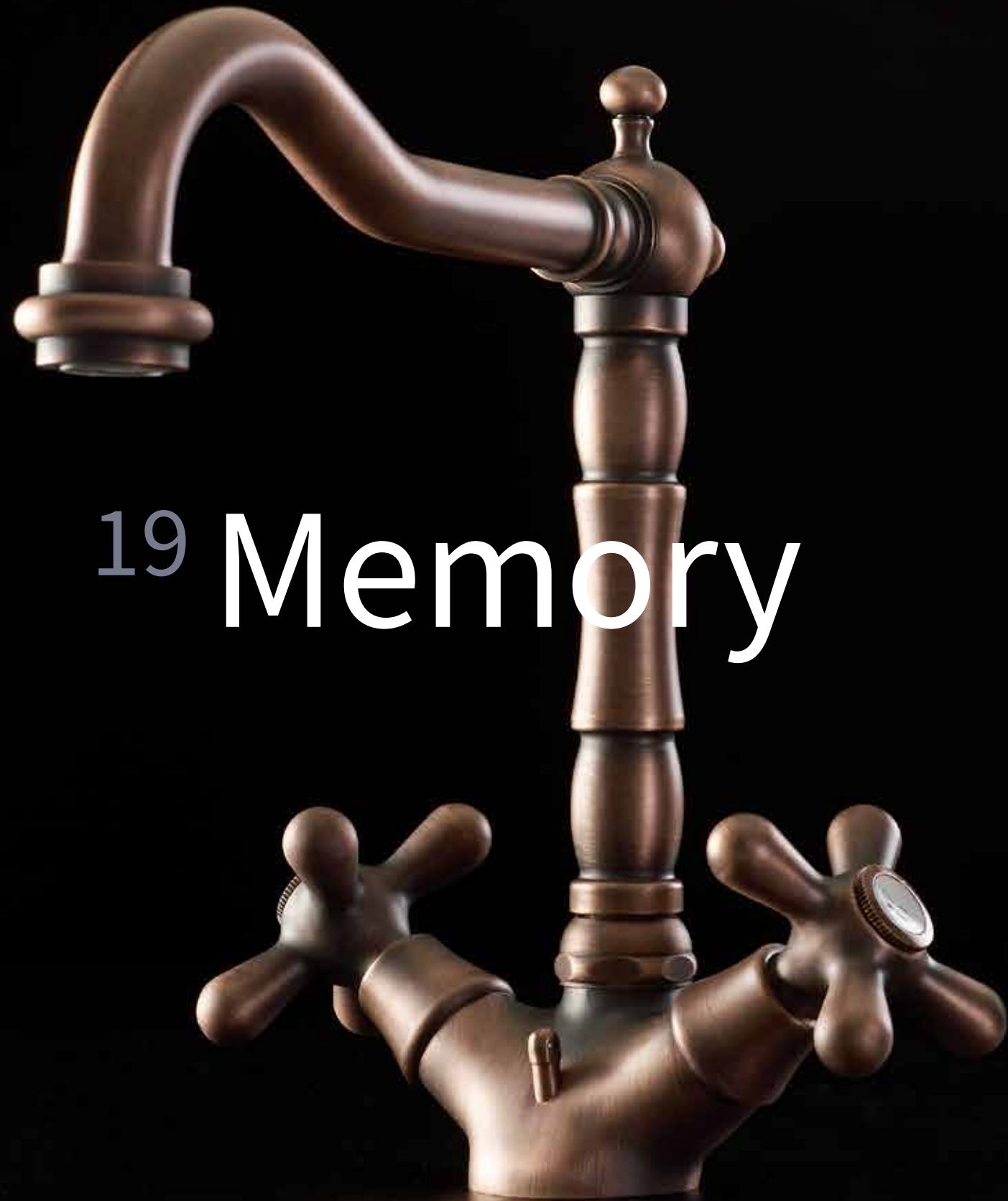

19 Memory



Memory



La emoción vintage. Si te exalta lo nuevo y te enamora lo antiguo, Memory merece un rincón especial en tu baño. Reivindica lo clásico con una colección memorable digna de pasar a la historia.

The vintage enthusiasm. If you are excited by the new and fall in love with the antique, Memory deserves a special corner in your bathroom. Reclaim the classic with a memorable collection worthy of make history.



CR
Cromo
Chrome
Chrome
Chrom
Хром



BR
Bronce antiguo mate
Old matt bronze
Vieux bronze mat
Altes bronze matt
Матовая состаренная бронза



O
Oro
Gold
Or
Gold
Золото



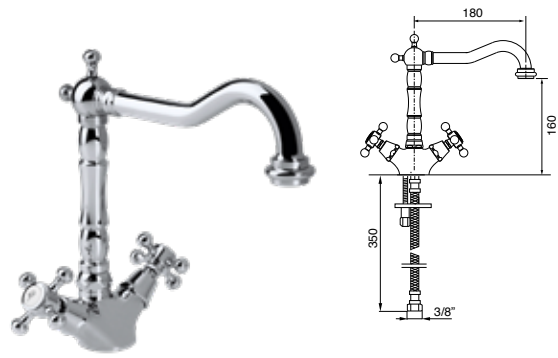

19 106 ●●●●

Monobloc lavabo alto giratorio
Single-hole basin mixer with swivel spout
Mélangeur monotrou lavabo bec haut fondu orientable
Drehbare waschtischbatterie
Смеситель для раковин вращающийся

19 108 ●●●●

Monobloc lavabo alto giratorio válv. desag. click-clack
Single-hole basin mixer with swivel spout with click-clack waste
Mélangeur monotrou lavabo bec haut fondu orientable avec vidage click-clack
Drehbare waschtischbatterie mit click-clack ablauf
Смеситель для раковины вращающийся с клапаном клик-клак



19 305 ●●●●

Bimando lavabo empotrado
Concealed 3 holes wash basin mixer
Mélangeur de lavabo 3 trous à encastrer
Unterputz 3-Loch Waschtischmischer
Встроенный смеситель для раковины на 3 отверстия

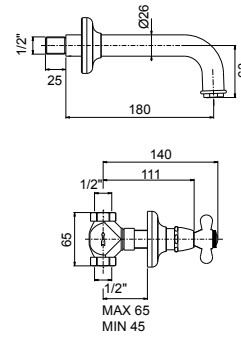

19 307 ●●●●

Bimando lavabo empotrado válv. desagüe click-clack
Concealed 3 holes wash basin mixer with click-clack waste
Mélangeur de lavabo 3 trous à encastrer avec vidage click-clack
Unterputz 3-Loch Waschtischmischer mit click-clack Ablaufgarnitur
Встроенный смеситель для раковины на 3 отверстия со сливом клик-клак



19 002 ●●●●

Monobloc lavabo
Single-hole wash-basin mixer
Mélangeur lavabo monotrou
1-loch-zweigriff-waschtischbatterie
Смеситель для раковины

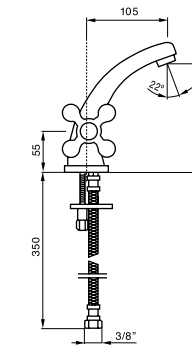

19 004 ●●●●

Monobloc lavabo válv. desag. click-clack
Single-hole wash-basin set with click-clack waste
Mélangeur lavabo avec vidage click-clack
Waschtischbatterie. click-clack ablauf
Смеситель для раковины с клапаном клик-клак



19 009 ●●●●

Monobloc bidé
Single-hole bidet
Mélangeur bidet
Bidetbatterie
Смеситель для биде

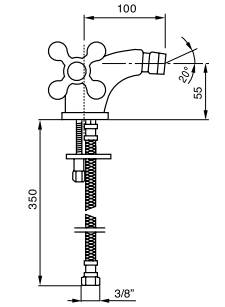

19 011 ●●●●

Monobloc bidé válv. desag. click-clack
Single-hole bidet set with click-clack waste
Mélangeur bidet avec vidage click-clack
Bidetbatterie. click-clack ablauf
Смеситель для биде с клапаном клик-клак



19 102 ●●●●

Monobloc lavabo giratorio
Basin mixer with swivel spout
Mélangeur lavabo bec haut orientable
Drehbare waschtischbatterie
Смеситель для раковины высокий

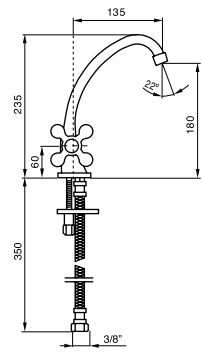

19 109 ●●●●

Monobloc bidé giratorio
Bidet mixer with swivel spout
Mélangeur lavabo bec haut orientable
Drehbare bidetbatterie
Смеситель для биде с поворотным изливом

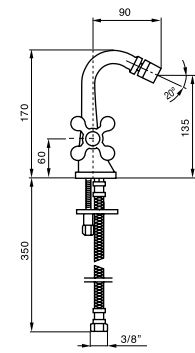

19 104 ●●●●

Monobloc lavabo alto válv. desag. click-clack
Single-hole high wash-basin set with click-clack waste
Mélangeur lavabo haut monotrou avec vidage click-clack
1-loch-zweigriff-waschtischbatterie hoher mit click-clack ablauf
Высокий смеситель для раковины с клапаном клик-клак

19 111 ●●●●

Monobloc bidé giratorio válv. desag. click-clack
Bidet mixer with click-clack waste
Mélangeur bidet avec vidage click-clack
Drehbare bidetbatterie mit click-clack ablauf
Смеситель для биде с поворотным изливом с донным клапаном клик-клак



19 112 ●●●●

Grupo baño ducha con accesorios
Bath shower mixer with accessories
Mélangeur bain-douche avec accessoires
Wannen und dusch batterie
Смеситель настенный ванна / душ с аксессуарами

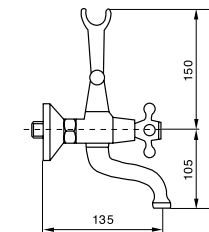

19 015 ●●●●

Grupo ducha con accesorios
Shower mixer with accessories
Mélangeur douche avec ensemble de douche
Dusch batterie mit zuberhör
Смеситель для душа настенного монтажа с аксессуарами

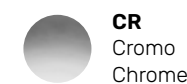
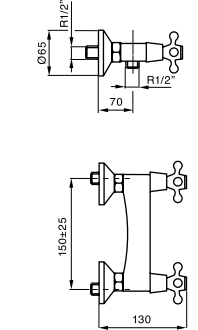

CR
Cromo
Chrome



BR
Bronce antiguo mate
Old matt bronze



O
Oro
Gold



19 005M ●●●●

Juego lavabo caño central
Wash basin in 3 holes mixer
Mélangeur 3 trous pour lavabo
Waschtischmischer dreilochbatterie
Смеситель для раковины на 3 отверстия



19 006M ●●●●

Juego bidé caño central
Bidet in 3 holes mixer
Mélangeur 3 trous pour bidet
Bidetbatterie dreilochbatterie
Смеситель для биде на 3 отверстия

19 075M ●●●●

Juego lavabo caño central válv. desag. click-clack
Wash basin in 3 holes mixer with click-clack waste
Mélangeur 3 trous pour lavabo avec vidage click-clack
Waschtischmischer dreilochbatterie mit click-clack ablauf
Смеситель для Раковины на 3 отверстия с клапаном клик-клак

19 008M ●●●●

Juego bidé caño central válv. desag. click-clack
Bidet in 3 holes mixer with click-clack waste
Mélangeur 3 trous pour bidet avec vidage click-clack
Bidetbatterie dreilochbatterie mit click-clack ablauf
Смеситель для биде на 3 отверстия с клапаном клик-клак

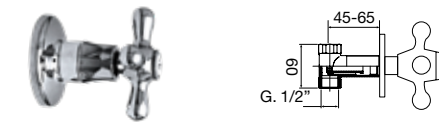

19 016 ●●●●

Llave de paso empotrar 1/2"
Built-in key step 1/2"
Robinet d'arrêt de 1/2"
Unterputz-ventil 1/2"
Кран встроенный 1/2"

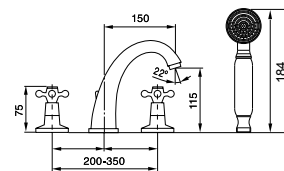

19 714M ●●●●

Grupo baño ducha 4 agujeros de repisa con ducha
Bath shower deck-mounted 4 holes mixer with handshower
Ensemble bain-douche 4 trous sur gorge avec ensemble de douche
Wannenrand bad und duschmischer
Смеситель на борт ванны для 4 отверстия с ручным душем

19 320 / 19 330 / 19 340 / 19 350 ●●●●

Distribuidor empotrar 2/3/4/5 salidas
Built-in diverter 2/3/4/5 ways
Inverseur 2/3/4/5 voies à encastrer
2/3/4/5-wege-umsteller
Встроенный дивертер на 2/3/4/5 выхода

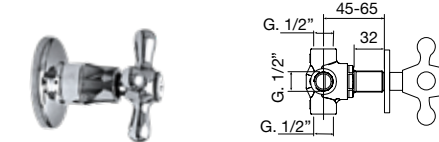

19 512 ●●●●

Grupo baño ducha con columnas suelo de 820 mm
Bath shower group with floor-standing columns of 820 mm
Mélangeur bain-douche sur colonnes de 820 mm
Wannen batterie mit 820 mm hohen boden anschluss, handbrause und flexiblen schlauch
Смеситель ванна / душ с напольными колоннами 820 мм



19 419-M200 ●●●●

Columna ducha clásica cilíndrica telescópica con rociador M200 con desviador
Round telescopic classic shower column with showerhead M200 with diverter
Barre de douche ronde télescopique classique avec pomme de douche M200 et inverseur
Klassisch runde brausegarnitur M200 bewegliche kopfbrause handbrause, brausehalter und umschalter
Термостатический классический душевой комплект с колонной цилиндрической телескопической, с верхним душем D200

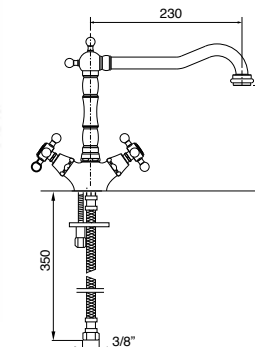

19 065 Kitchen ●●●●

Grifo de cocina bimando
Two-handle sink mixer
Mélangeur évier
Zweigriff-Küchenmischer
Смеситель для кухонной мойки



CR
Cromo
Chrome



BR
Bronce antiguo mate
Old matt bronze



O
Oro
Gold

70 Kromo therapy

Kromotherapy



Baño de color. Siete colores para siete sensaciones. Una terapia de agua y luz que remueve cuerpo y mente gracias a la última tecnología en iluminación LED. Nada será igual después de experimentar la colección Kromoterapia.

Color rain over you. Seven colors for seven sensations. A water and light therapy that moves body and mind through latest technology in LED illumination. Nothing will be the same after experiencing the Kromotherapy collection.



 Lluvia
Rainfall
Дождь



 Cascada
Waterfall
Каскад



 Cascada Cortina
Curtain Waterfall
Тропический Каскад



 Chorros Espiral
Spiral Waterjets
Спиральные Форсунки



 Chorro
Waterjet
Ламинарная Струя



 Chorro Ondulado
Twist Waterjet
Спиральная Струя



CR
Cromo
Chrome
Chrome
Chrom
Хром



NG
Negro mate
Matt black
Noir mate
Schwarz matte
Черное



BL
Blanco mate
Matt white
Blanche mate
Weisse matte
Белое



NI
Níquel cepillado mate
Matt brushed nickel
Matt brossé nickel
Matt gebürstetes Nickel
Брашированный матовый никел



O
Oro
Gold
Or
Gold
Золото



OC
Oro cepillado
Brushed gold
Or brossé
Gebürstetes gold
Брашированное золото



 Mando a distancia
Remote control
пульт управления

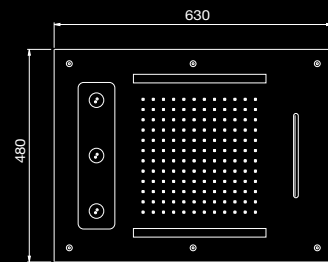

70 K603 ●●●●●●

Rociador cromoterapia para falso techo inox 630x480 mm de 3 funciones: lluvia, chorros espiral y cascada cortina. 3 vías de agua. Incluye mando a distancia
 False ceiling chromotherapy inox showerhead 630x480 mm with 3 functions: rainfall, spiral waterjets and curtain waterfall. 3 water ways. Includes remote control
 Душевая лейка для подвесного потолка 630x480 mm. Виды струи: дождь, спиральные форсунки, и каскад. 3 Источника воды. Пульт управления в комплекте



- 
CR
 Cromo
 Chrome
- 
BL
 Blanco mate
 Matt white
- 
NG
 Negro mate
 Matt black
- 
NI
 Níquel cepillado mate
 Matt brushed nickel
- 
O
 Oro
 Gold
- 
OC
 Oro cepillado
 Brushed gold



- A 70 K603 CR**
 Rociador cromoterapia para falso techo inox 630x480 mm de 3 funciones: lluvia, chorros espiral y cascada cortina. 3 Vías de agua. Incluye mando a distancia.
 False ceiling chromotherapy inox showerhead 630x480 mm with 3 functions: rainfall, spiral waterjets and curtain waterfall. 3 Water ways. Includes remote control.
- B 73 340 CR**
 Distribuidor empotrar 4 salidas
 Built-in diverter 4 ways
- C 73 016 CR**
 Llave de paso empotrar 1/2"
 Built-in key step 1/2"
- D 60 120 CR**
 Toma 1/2" - 1/2" cilíndrica
 Round wall outlet 1/2" - 1/2"
- E 21 097 CR**
 Flexo 1,70 m pvc
 Flexible hose 1,70 m pv
- F 21 132 CR**
 Ducha teléfono abs Mini Star
 Hand shower abs Mini Star
- G 21 118 CR**
 Barra deslizante de ducha Mini Star
 Shower sliding bar Mini Star

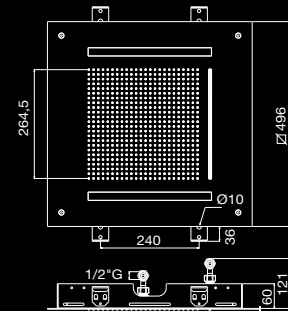

70 K502 ●●●●●●

Rociador cromoterapia para falso techo inox 500x500 mm de 2 funciones: lluvia y cascada. 2 Vías de agua. Incluye mando a distancia
 False ceiling chromotherapy inox showerhead 500x500 mm with 2 functions: rainfall and waterfall. 2 Water ways. Includes remote control
 Душевая лейка цветотерапии для подвесного потолка нержавеющей 500x500 мм. 2 Режимы струи: дождь и каскад. 2 Выхода воды. Пульт управления включен в комплект

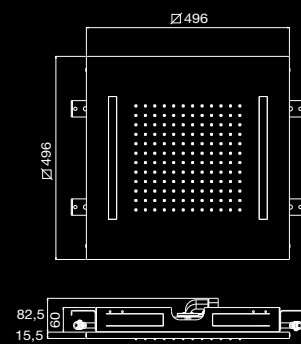

70 K500 ●●●●●●

Rociador cromoterapia para falso techo inox 500x500 mm de 1 función: lluvia. 1 vía de agua. Incluye mando a distancia
 False ceiling chromotherapy inox showerhead 500x500 mm with 1 function: rainfall. 1 water way. Includes remote control
 Душевая лейка для подвесного потолка с цветотерапии 500 x 500 мм. Виды струи: дождь. С 1-ходовым. Пульт управления в комплекте



- | | | | | | |
|------------------------------|--|---------------------------------------|---|-------------------------|--|
| | | | | | |
| CR
Cromo
Chrome | BL
Blanco mate
Matt white | NG
Negro mate
Matt black | NI
Níquel cepillado mate
Matt brushed nickel | O
Oro
Gold | OC
Oro cepillado
Brushed gold |

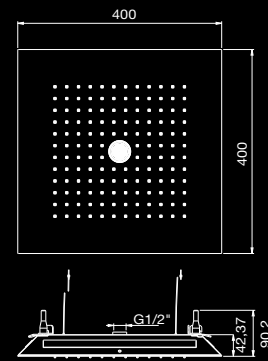
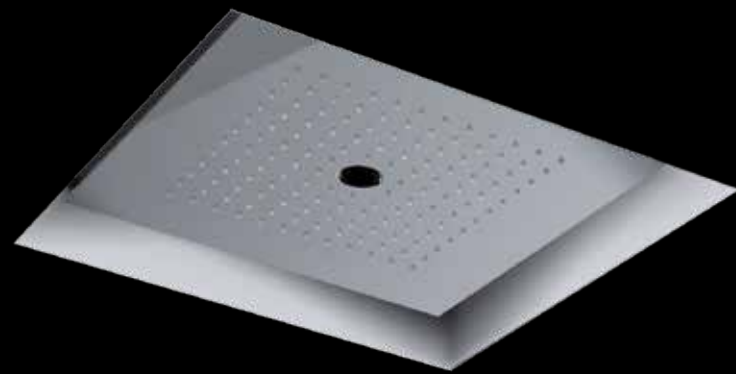

70 K402 ●●●

Rociador cromoterapia para falso techo inox 470x470 mm de 2 funciones: lluvia y chorro. 2 vías de agua. Incluye mando a distancia y marco empotrado metálico
 False ceiling chromotherapy inox showerhead 470x470 mm with 2 functions: rainfall and waterjet. 2 water ways. Includes remote control and built-in frame
 Душевая лейка для подвесного потолка с хромотерапией 470x470 мм. 2 Вида струи: дождь и ламинарная струя. Включая пульт управления и встроенную раму

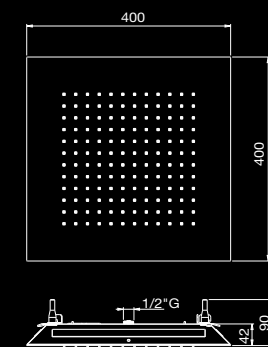
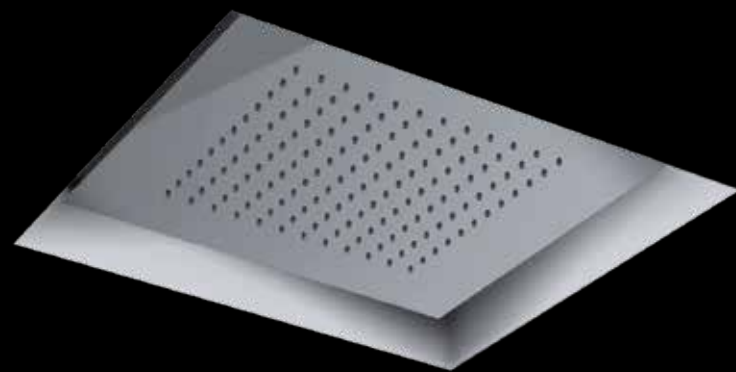

70 K400 ●●●

Rociador cromoterapia para falso techo inox 470x470 mm de 1 función: lluvia. 1 vía de agua. Incluye mando a distancia y marco empotrado
 False ceiling chromotherapy inox showerhead 470x470 mm with 1 function: rainfall. 1 water way. Includes remote control and built-in frame
 Душевая лейка для подвесного потолка с хромотерапией 470x470 мм. 1 Вид струи: дождь. Включая пульт управления и встроенную раму



CR
Cromo
Chrome

NI
Níquel cepillado mate
Matt brushed nickel





60 Hydrotherapy

Hydrotherapy



El estímulo de la lluvia. Una experiencia en cada sesión, una sorpresa en cada gota de agua. La caída de la ducha de Hydroterapia proporciona un estímulo sensorial y una sensación de relajación única.

The rain stimulation. An experience in each session, a surprise in every drop of water. The falling of Hydrotherapy rain shower provides a sensory stimulus and a unique sense of relaxation.



CR
Cromo
Chrome
Chrome
Chrom
Хром



NG
Negro mate
Matt black
Noir mate
Schwarz matte
Черное



BL
Blanco mate
Matt white
Blanche mate
Weisse matte
Белое



O
Oro
Gold
Or
Gold
Золото



OR
Oro rosa
Rose gold
Or rosé
Rose Gold
Розовое золото



OC
Oro cepillado
Brushed gold
Or brossé
Gebürstetes gold
Брашированное золото



CO
Cobre mate
Matt copper
Cuivre mat
Kupfer matt
Матовая медь



BR
Bronce antiguo mate
Old matt bronze
Vieux bronze mat
Altes bronze matt
Матовая состаренная бронза



NI
Níquel cepillado mate
Matt brushed nickel
Matt brossé nickel
Matt gebürstetes Nickel
Брашированный матовый никел

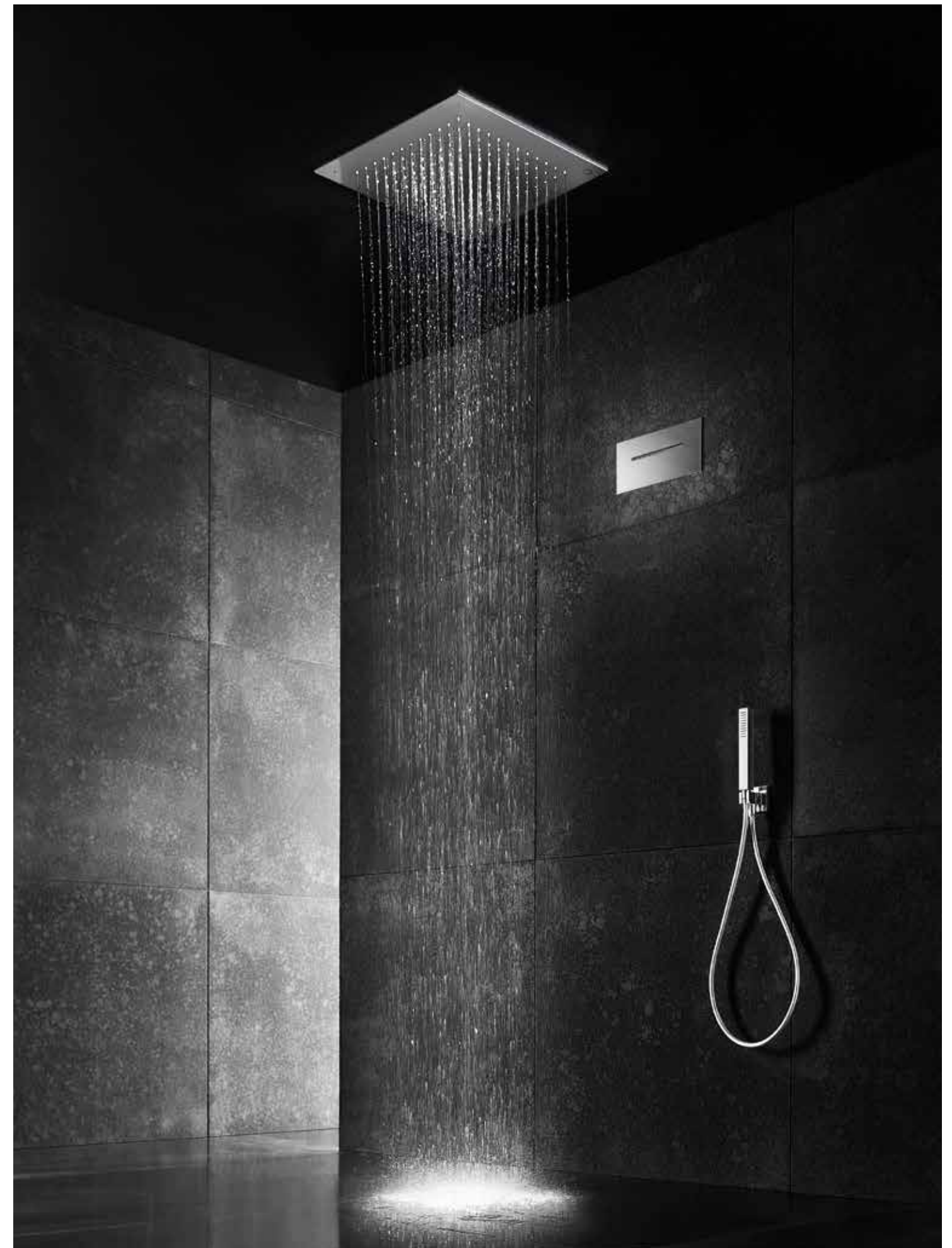

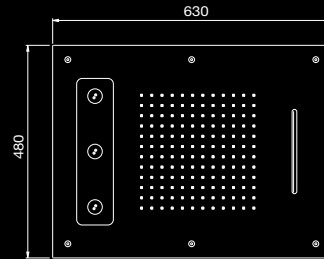
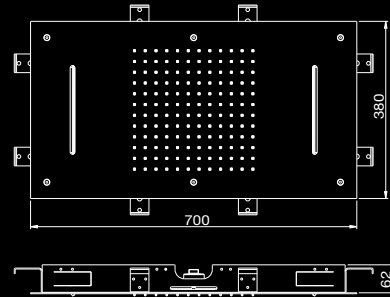

80 K702 ●●●●●●●●●●

Rociador para falso techo inox 700x380 mm de 2 funciones: lluvia y doble cascada. 2 Vías de agua
 False ceiling inox showerhead 700x380 mm with 2 functions: rainfall and double waterfall. 2 Water ways
 Душевая лейка нержавеющая для подвесного потолка 700x380 mm. 2 Режима струи: дождь и двусторонний каскад. 2 Выхода воды

80 K603 ●●●●●●●●●●

Rociador para falso techo inox 630x480 mm de 3 funciones: lluvia, chorros espiral y cascada cortina. 3 Vías de agua
 False ceiling inox showerhead 630x480 mm with 3 functions: rainfall, spiral waterjets and curtain waterfall. 3 Water ways
 Душевая лейка нержавеющая для подвесного потолка 630x480 mm. 3 Режима струи: дождь, спиральные форсунки и каскад. 3 Выхода воды.

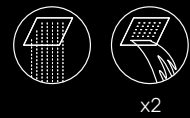

x2

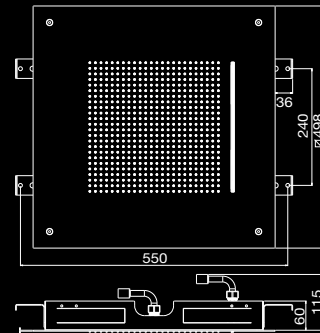

80 K502 ●●●●●●●●●●

Rociador para falso techo inox 500x500 mm de 2 funciones: lluvia y cascada. 2 Vías de agua
 False ceiling inox showerhead 500x500 mm with 2 functions: rainfall and waterfall. 2 Water ways
 Душевая лейка нержавеющая для подвесного потолка 500x500 mm. 2 Режима струи: дождь и каскад. 2 Выхода воды.



- | | | | | | | | | |
|------------------------------|--|---------------------------------------|--|---|---|-------------------------|------------------------------------|--|
| | | | | | | | | |
| CR
Cromo
Chrome | BL
Blanco mate
Matt white | NG
Negro mate
Matt black | CO
Cobre mate
Matt copper | BR
Bronce antiguo mate
Old matt bronze | NI
Níquel cepillado mate
Matt brushed nickel | O
Oro
Gold | OR
Oro Rosa
Rose Gold | OC
Oro cepillado
Brushed gold |



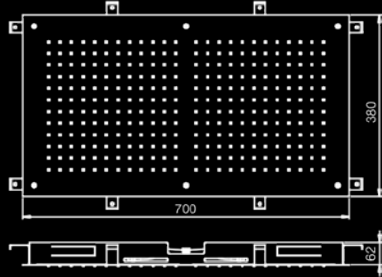
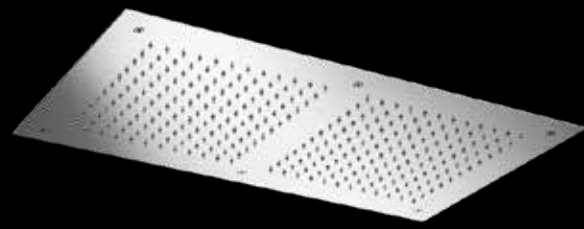

80 K700 ●●●●●●●●●●

Rociador para falso techo inox 700x380 mm de 1 función: lluvia.
1 Vía de agua.
False ceiling inox showerhead 700x380 mm with 1 function: rainfall. 1 Water way
Душевая лейка для подвешного потолка нержавеющей 700x380 mm. 1 Режим струи: дождь. 1 Выход воды

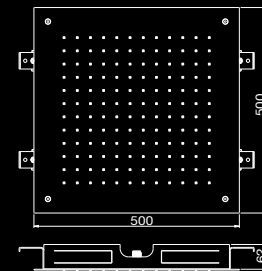
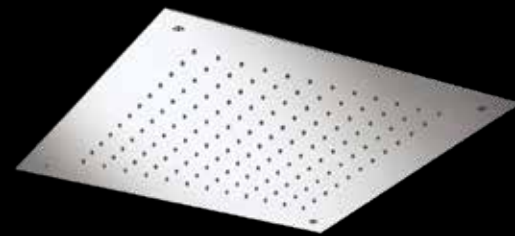

80 K500 ●●●●●●●●●●

Rociador para falso techo inox 500x500 mm
False ceiling inox showerhead 500x500 mm
Душевая лейка нержавеющей для подвешного потолка 500 x 500 mm

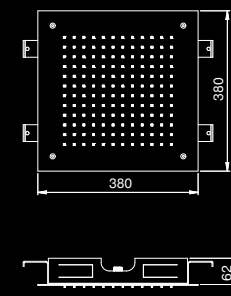
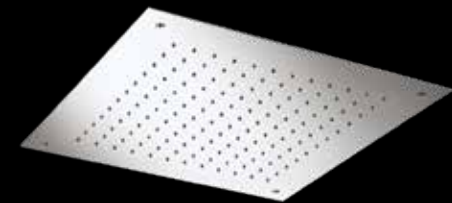

80 K400 ●●●●●●●●●●

Rociador para falso techo 380x380 mm
False ceiling showerhead 380x380 mm
Душевая лейка для подвешного потолка 380x380 mm

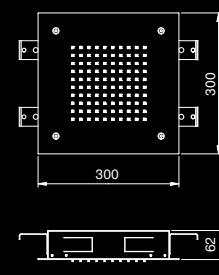
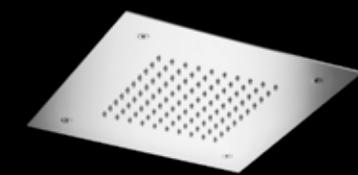

80 K300 ●●●●●●●●●●

Rociador para falso techo 300x300 mm
False ceiling showerhead 300x300 mm
Душевая лейка для подвешного потолка 300x300 mm

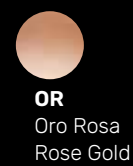
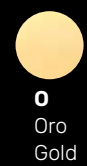
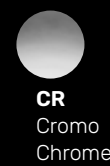

- A** 80 K400 NG
Rociador para falso techo 400 x 400 mm
False ceiling showerhead 400 x 400 mm
- B** 60145 NG
Jet lateral de ducha orientable 65x65 mm cuadrado orientable
Square lateral body jet 65x65 mm
- C** 58 330 NG
Distribuidor empotrar 3 salidas
Built-in diverter 3 ways
- D** 58 315 NG
Monomando empotrar ducha
Built-in shower mixer
- E** 60 123 NG
Toma 1/2" - 1/2" cuadrada con soporte
Square wall outlet 1/2" - 1/2" with support
- F** 21 097 NG
Flexo 1,70 m pvc
Flexible hose 1,70 m pvc
- G** 21 136 NG
Ducha hidromasaje 2 jets con pulsador D 120 mm
Hand shower hydromassage 2 sprays with push button D120 mm

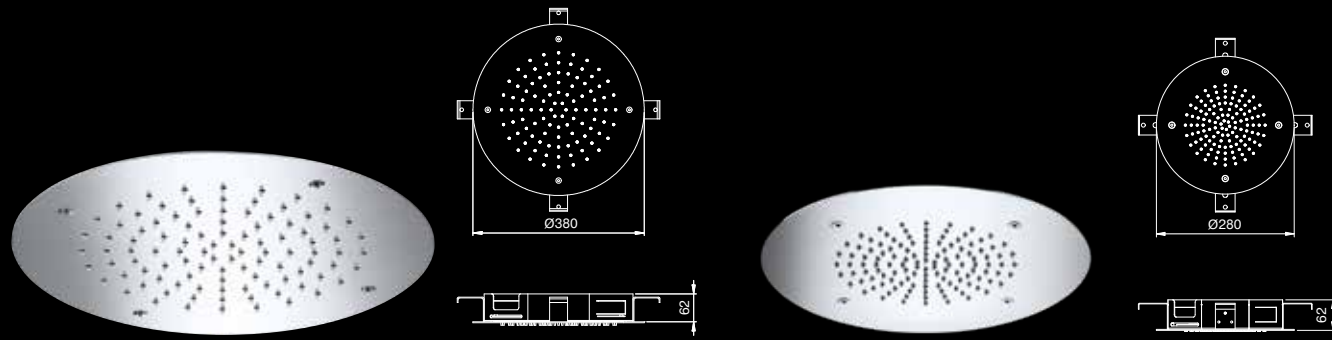

80 D400

Rociador para falso techo Ø 380 mm
False ceiling showerhead Ø 380 mm
Душевая лейка для подвесного потолка Ø 380 mm



80 D300

Rociador para falso techo Ø 280 mm
False ceiling showerhead Ø 280 mm
Душевая лейка для подвесного потолка Ø 280 mm

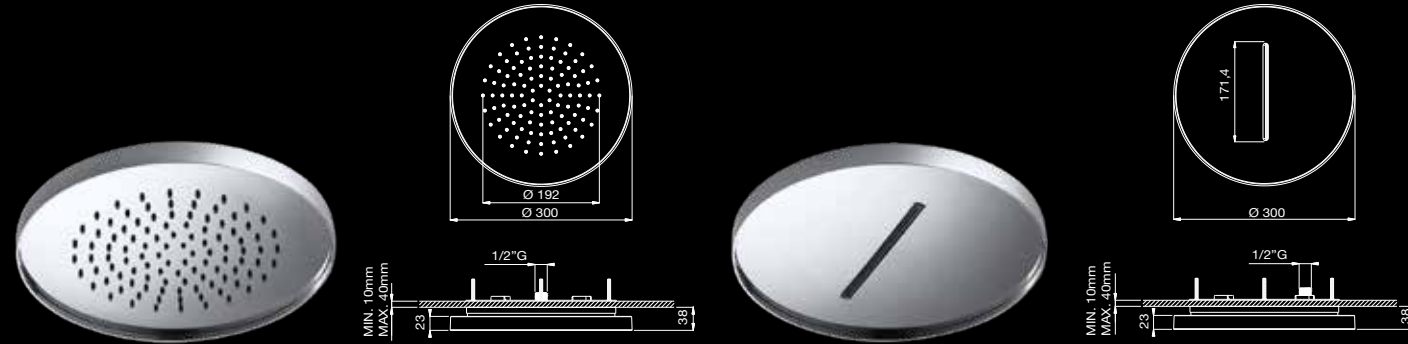

80 S300

Rociador lluvia de superficie Ø 300 mm
Rainfall showerhead surface Ø 300 mm
Душевая лейка на потолок с функцией дождевого душа Ø 300 mm



80 S300W

Rociador cascada de superficie Ø 300 mm
Waterfall showerhead surface Ø 300 mm
Душевая лейка на потолок с функцией cascada Ø 300 mm

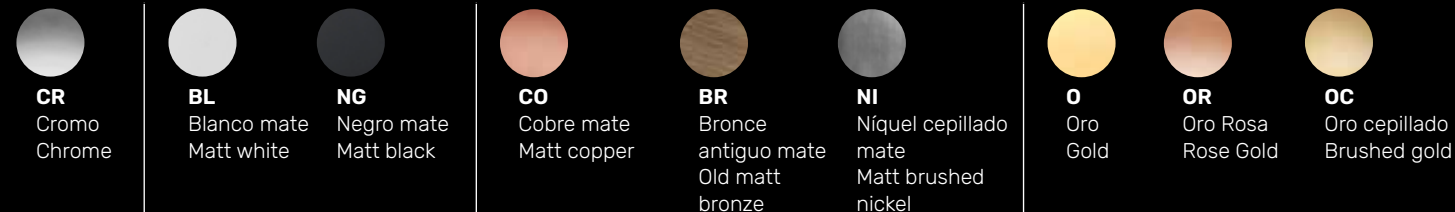

- A 80S300W CR**
Rociador cascada de superficie ø 300mm
Waterfall showerhead surface ø 300mm
- B 80S300 CR**
Rociador lluvia de superficie ø 300 mm
Rainfall showerhead surface ø 300 mm
- C 47330 CRRO**
Distribuidor empotrar 3 salidas
Built-in diverter 3 ways
- D 47016 CRRO**
Llave de paso empotrar ½"
Built-in key step ½"
- E 60121 CR**
Toma ½" - ½" cilíndrica con soporte
Round Wall outlet ½"-1/2" with support
- F 21097 CR**
Flexo 1,70 m pvc
Flexible hose 1,70 m pvc
- G 21139 CR**
Ducha teléfono Mini star latón
Hand shower Mini star brass

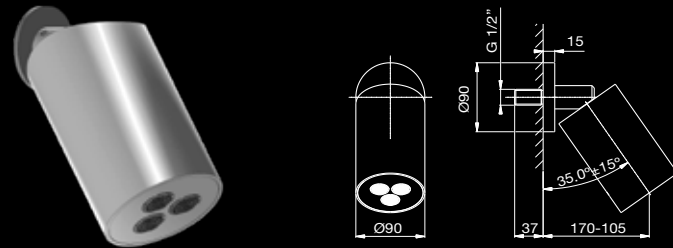

60 D090 ●●●●●●●●●●

Rociador a pared orientable Ø 90 mm
Orientable showerhead inox wall mounted Ø 90 mm
Душевая лейка настенная ориентируемая нержавеющая Ø 90 mm

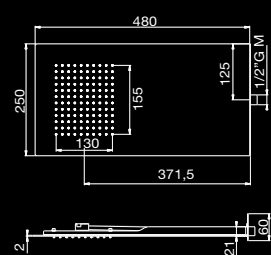
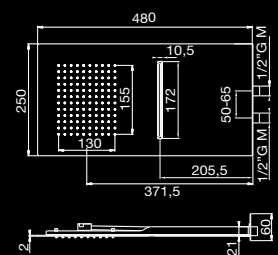

60 C402 ●●●●●●●●●●

Rociador a pared 480x250 mm y grosor de 2 mm. 2 funciones: lluvia y cascada. Instalar con un grifo de 2 vías.
Wall Mounted showerhead 480x250 mm and 2 mm thickness. 2 functions: rain and waterfall. Install with 2-way mixer.
Настенная душевая лейка 480x250 мм. виды струи: тропический дождь/ каскад. должна устанавливаться с 2-ходовым смесителем.



60 R400 ●●●●●●●●●●

Rociador a pared 480x250 mm y grosor de 2 mm.
Wall Mounted showerhead 480x250 mm and 2 mm thickness.
Pomme de douche au mur 480x250 mm et épaisseur 2mm.
Wandbrause 480x250 mm und einer Wanddicke von 2 mm.
Настенная душевая лейка 480x250 мм.



- | | | | | | | | | |
|------------------------------|--|---------------------------------------|--|---|---|-------------------------|------------------------------------|--|
| | | | | | | | | |
| CR
Cromo
Chrome | BL
Blanco mate
Matt white | NG
Negro mate
Matt black | CO
Cobre mate
Matt copper | BR
Bronce antiguo mate
Old matt bronze | NI
Níquel cepillado mate
Matt brushed nickel | O
Oro
Gold | OR
Oro Rosa
Rose Gold | OC
Oro cepillado
Brushed gold |



- A** 43502 NI
Grifo exento lavabo 1130 mm redondo
Floorstanding washbasin mixer 1130 mm round
- B** 60D090 NI
Rociador a pared orientable ø 90 mm
Orientable showerhead inox wall mounted Ø 90 mm
- C** 43322 NI
Conjunto monomando ducha empotrado 2 vías con toma con soporte, ducha y flexo 1,70 m
Concealed shower set with shower mixer 1-way, diverter 2 ways, wall outlet with support, handshower and flexible hose 1,70 m



- A 80 K450 O**
Rociador para falso techo 400 x 400 mm Swarovski
False ceiling showerhead 400 x 400 mm with Swarovski
- B 60 146 O**
Jet lateral de ducha orientable D65 mm redondo con Swarovski
Orientable round lateral body jet D65 mm with Swarovski
- C 67 603R O**
Termostático baño ducha empotrar con inversor 3 vías
Thermostatic concealed bath shower with diverter 3 ways
- D 60 121 O**
Toma 1/2" - 1/2" cilíndrica con soporte
Round wall outlet 1/2" - 1/2" with support
- E 21 097 O**
Flexo 1,70 m pvc
Flexible hose 1,70 m pvc
- F 21 139 O**
Ducha teléfono Mini Star latón
Hand shower Mini Star brass

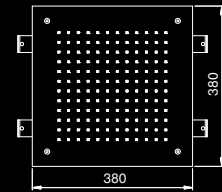

80 K450 ●●●●●●●●●●

Rociador para falso techo 380x380 mm Swarovski
False ceiling showerhead 380x380 mm Swarovski
Душевая лейка для подвесного потолка 380x380 mm Swarovski



21 621 ●●●●●●●●●●

Kit ducha redondo de latón, flexo 1,25 m y soporte Swarovski
Round shataff brass with flexible hose 1,25 m and support Swarovski
Connexion flexible 1,25 m avec support douche rond laiton et douche kit Swarovski
Bidet duschet 1,25 m flexiblen schlauch und brausehalter Swarovski
Набор гигиенического душа круглый из латуни с душевым шлангом 1,25 м и с держателем Swarovski

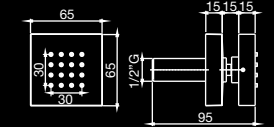
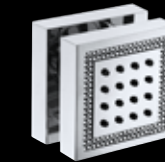

60 147 ●●●●●●●●●●

Jet lateral de ducha orientable 65x65 mm cuadrado Swarovski
Orientable square lateral body jet 65x65 mm Swarovski
Body jet latéral orientable carré 65x65 mm Swarovski
Seitenbrause ausrichtbar 65x65 eckig Swarovski
вадратная регулируемая боковая форсунка 65x65 mm Swarovski

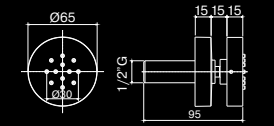
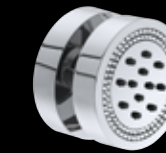

60 146 ●●●●●●●●●●

Jet lateral de ducha orientable Ø 65 mm redondo Swarovski
Orientable round lateral body jet Ø 65 mm Swarovski
Body jet latéral orientable ronde Ø 65 mm Swarovski
Seitenbrause ausrichtbar Ø 65 mm rund Swarovski
Круглая регулируемая боковая форсунка Ø 65 mm Swarovski

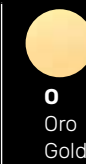
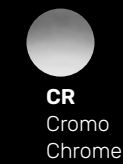



A 42005G1 CR
Juego lavabo caño central
Wash basin in 3 holes mixer

B 60D300 CR
Rociador ducha redondo latón D300 mm h 9 mm
Round showerhead brass D300 mm h 9 mm

C 60180 CR
Brazo ducha pared ½" 35 cm
Ceiling arm ½" 35 cm

D 42320G1 CR
Distribuidor empotrar 2 salidas
Built-in diverter 2 ways

E 42016G1 CR
Llave de paso empotrar ½"
Built-in key step ½"

F 60121 CR
Toma ½" - ½" cilíndrica con soporte
Round Wall outlet ½"-1/2" with support

G 21097 CR
Flexo 1,70 m pvc
Flexible hose 1,70 m pvc

H 21139 CR
Ducha teléfono Mini Star latón
Hand shower Mini Star brass



60 D200

Rociador ducha redondo latón D200 mm h 9mm
Round showerhead brass D200 mm h 9mm
Pomme de douche ronde laiton D200 mm h 9mm
Runde kopfbrause D200 mm verchromter messing h 9mm
Распылитель душ круглый латунь d200 mm h 9mm



60 K200

Rociador ducha cuadrado latón 200x200 mm h 8mm
Square showerhead brass 200x200 mm h 8mm
Pomme de douche square laiton 200 x 200 mm h 8mm
Quadrat kopfbrause 200x200 mm verchromter messing h 8mm
Распылитель душ квадратный латунь 200x200 мм h 8mm



60 D300

Rociador ducha redondo latón D300 mm h 9mm
Round showerhead brass D300 mm h 9mm
Pomme de douche ronde laiton D300 mm h 9mm
Runde kopfbrause D300 mm verchromter messing h 9mm
Распылитель душ круглый латунь d300 mm h 9mm



60 K300

Rociador ducha cuadrado latón 300x300 mm h 8mm
Square showerhead brass 300x300 mm h 8mm
Pomme de douche square laiton 300 x 300 mm h 8mm
Quadrat kopfbrause 300x300 mm verchromter messing h 8mm
Распылитель душ квадратный латунь 300x300z mm h 8mm



60 D400

Rociador ducha redondo latón D400 mm h 7mm
Round showerhead brass D400 mm h 7mm
Pomme de douche ronde laiton D400 mm h 7mm
Runde kopfbrause D400 mm verchromter messing h 7mm
Распылитель душ круглый латунь d400 mm h 7mm



60 K400

Rociador ducha cuadrado latón 400x400 mm h 7mm
Square showerhead brass 400x400 mm h 7mm
Pomme de douche square laiton 400x400 mm h 7mm
Quadrat kopfbrause 400x400 mm verchromter messing h 7mm
Распылитель душ квадратный латунь 400x400 mm h 7mm



60 D500

Rociador ducha redondo latón D500 mm h 7mm
Round showerhead brass D500 mm h 7mm
Pomme de douche ronde laiton D500 mm h 7mm
Runde kopfbrause D500 mm verchromter messing h 7mm
Распылитель душ круглый латунь d500 mm h 7mm



60 K500

Rociador ducha cuadrado latón 500x500 mm h 7mm
Square showerhead brass 500x500 mm h 7mm
Pomme de douche carré laiton 500x500 mmh 7mm
Quadrat kopfbrause 500x500 mm verchromter messing h 7mm
Распылитель душ квадратный латунь 500x500 mm h 7mm



A 43 302 OC
Monomando lavabo empotrado
Built-in single-lever wash-basin mixer

B 21 607 OC
Sifón botella lavabo redondo latón
Basin trap round brass

C 80 K700 OC
Rociador para falso techo inox 700x380 mm
de 1 función: lluvia. 1 vía de agua
False ceiling inox showerhead 700x380 mm
with 1 function: rainfall. 1 water way

D 43 322 OC
Conjunto monomando ducha empotrado 2 vías con
toma con soporte, ducha y flexo 1,70 m
Concealed shower set with shower mixer 1-way,
diverter 2 ways, wall outlet with support, handheld
and flexible hose 1,70 m

E 43 512 OC
Grifo exento baño/ducha 1150 mm redondo con
accesorios
Floorstanding bath/shower mixer 1150 mm round with
accessories



43 317 ●●●●●●●●●●

Conjunto monomando ducha empotrado 1 vía con toma con soporte, ducha y flexo 1,70 m
 Concealed shower set with shower mixer 1-way, wall outlet with support, handshower and flexible hose 1,70 m
 Встроенный душевой комплект на 1 выход с соединителем с держателем, ручным душем и душевым шлангом 1,70 м

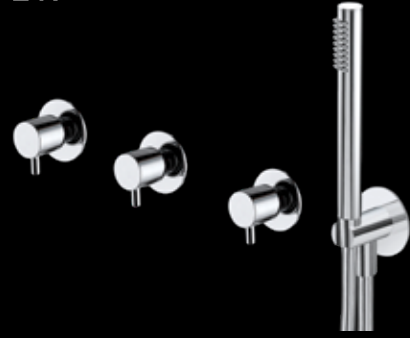

43 362 / 43 363 / 43 364 / 43 365 ●●●●●●●●●●

Conjunto bimando ducha empotrado 2/3/4/5 vías con toma con soporte, ducha y flexo 1,70 m
 Concealed bath shower set with two-handle shower keys, diverter 2/3/4/5 ways, wall outlet with support, handshower and flexible hose 1,70 m
 Встроенный душевой комплект на 4 отверстия на 2/3/4/5 выходов с соединителем с держателем, ручным душем и душевым шлангом 1,70 м

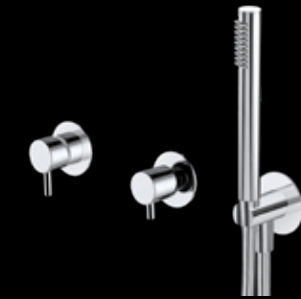

43 322 / 43 323 / 43 324 / 43 325 ●●●●●●●●●●

Conjunto monomando ducha empotrado 2/3/4/5 vías con toma con soporte, ducha y flexo 1,70 m
 Concealed shower set with shower mixer 1-way, diverter 2/3/4/5 ways, wall outlet with support, handshower and flexible hose 1,70 m
 Встроенный душевой комплект на 2/3/4/5 выходов с соединителем с держателем, ручным душем и душевым шлангом 1,70 м



43 316 ●●●●●●●●●●

Conjunto monomando 2 salidas con toma con soporte, ducha y flexo 1,70 m
 Concealed bath shower set with mixer 2-ways, wall outlet with support, handshower and flexible hose 1,70 m
 Встроенный душевой комплект однорычажный на 2 выхода с соединителем с держателем, ручным душем и душевым шлангом 1,70 м



43 314 ●●●●●●●●●●

Conjunto monomando baño/ducha empotrado 2/3/4/5 vías con caño, toma con soporte, ducha y flexo 1,70 m
 Concealed bath shower set with shower mixer 1-way, diverter 2/3/4/5 ways, wall outlet with support, handshower and flexible hose 1,70 m
 Встроенный душевой комплект на 2/3/4/5 выходов с настенным изливом, соединителем с держателем, ручным душем и душевым шлангом 1,70 м



43 622 / 43 623 ●●●●●●●●●●

Conjunto termostático 2/3 vías con toma con soporte, ducha y flexo 1,70 m
 Concealed bath shower set with thermostatic mixer 2/3 ways, wall outlet with support, handshower and flexible hose 1,70 m
 Термостатический встроенный душевой комплект на 2/3 выхода с соединителем с держателем, ручным душем и душевым шлангом 1,70 м



- A** 80 K700 OC
 Rociador para falso techo inox 700x380 mm de 1 función: lluvia. 1 vía de agua
 False ceiling inox showerhead 700x380 mm with 1 function: rainfall. 1 water way
- B** 60 149 OC
 Jet lateral de ducha orientable 125x125 mm cuadrado
 Orientable square lateral body jet 125x125 mm
- C** 43 323 OC
 Conjunto monomando ducha empotrado 3 vías con toma con soporte, ducha y flexo 1,70 m
 Concealed shower set with shower mixer 1-way, diverter 3 ways, wall outlet with support, handshower and flexible hose 1,70 m



43 651 ●●●●●●●●●●

Conjunto termostático ducha empotrado 1 vía con toma con soporte, ducha y flexo 1,70 m
 Concealed shower set with thermostatic mixer 1-way, wall outlet with support, handshower and flexible hose 1,70 m
 Термостатический встроенный душевой комплект на 1 выход с соединителем с держателем, ручным душем и душевым шлангом 1,70 м



43 652 / 43 653 / 43 654 / 43 655 ●●●●●●●●●●

Conjunto termostático ducha empotrado 2/3/4/5 vías con toma con soporte, ducha y flexo 1,70 m
 Concealed shower set with thermostatic mixer 1-way, diverter 2/3/4/5 ways, wall outlet with support, handshower and flexible hose 1,70 m
 Термостатический встроенный душевой комплект на 2/3/4/5 выходов с соединителем с держателем, ручным душем и душевым шлангом 1,70 м

MAIER



A

A 60R400 NG
Rociador a pared 480 x 250 mm y grosor de 2 mm
Wall mounted showerhead 480 x 250 mm and 2 mm thickness

B 48322 NG
Conjunto monomando ducha empotrado 2 vías con toma con soporte, ducha y flexo 1,70 m
Concealed shower set with shower mixer 1-way, diverter 2 ways, wall outlet with support, handshower and flexible hose 1,70 m



B

60 Hydrotherapy



48 317 ●●●●●●●●

Conjunto monomando ducha empotrado 1 vía con toma con soporte, ducha y flexo 1,70 m
Concealed shower set with shower mixer 1-way, wall outlet with support, handshower and flexible hose 1,70 m
Встроенный душевой комплект на 1 выход с соединителем с держателем, ручным душем и душевым шлангом 1,70 м

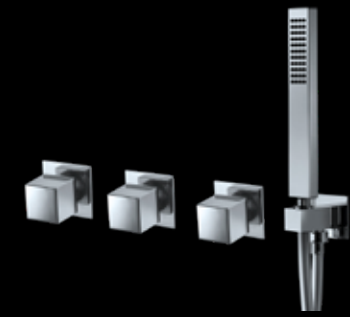

48 362 /48 363 /48 364 /48 365 ●●●●●●●●

Conjunto bimando ducha empotrado 2/3/4/5 vías con toma con soporte, ducha y flexo 1,70 m
Concealed bath shower set with two-handle shower keys, diverter 2/3/4/5 ways, wall outlet with support, handshower and flexible hose 1,70 m
Встроенный душевой комплект на 4 отверстия на 2/3/4/5 выходов с соединителем с держателем, ручным душем и душевым шлангом 1,70 м



48 322 /48 323 /48 324 /48 325 ●●●●●●●●

Conjunto monomando ducha empotrado 2/3/4/5 vías con toma con soporte, ducha y flexo 1,70 m
Concealed shower set with shower mixer 1-way, diverter 2/3/4/5 ways, wall outlet with support, handshower and flexible hose 1,70 m
Встроенный душевой комплект на 2/3/4/5 выходов с соединителем с держателем, ручным душем и душевым шлангом 1,70 м



48 316 ●●●●●●●●

Conjunto monomando 2 salidas con toma con soporte, ducha y flexo 1,70 m
Concealed bath shower set with mixer 2-ways, wall outlet with support, handshower and flexible hose 1,70 m
Встроенный душевой комплект однорычажный на 2 выхода с соединителем с держателем, ручным душем и душевым шлангом 1,70 м



48 314 ●●●●●●●●

Conjunto monomando baño/ducha empotrado 2/3/4/5 vías con caño, toma con soporte, ducha y flexo 1,70 m
Concealed bath shower set with shower mixer 1-way, diverter 2/3/4/5 ways, wall outlet with support, handshower and flexible hose 1,70 m
Встроенный душевой комплект на 2/3/4/5 выходов с настенным изливом, соединителем с держателем, ручным душем и душевым шлангом 1,70 м



48 622 /48 623 ●●●●●●●●

Conjunto termostático 2/3 vías con toma con soporte, ducha y flexo 1,70 m
Concealed bath shower set with thermostatic mixer 2/3 ways, wall outlet with support, handshower and flexible hose 1,70 m
Термостатический встроенный душевой комплект на 2/3 выхода с соединителем с держателем, ручным душем и душевым шлангом 1,70 м



60 180

Brazo ducha pared redondo 1/2" 35 cm
Round wall arm 1/2" 35 cm
Bras de douche sortie mural ronde 1/2" x 35 cm
Runder wandträger. 1/2" x 35 cm
Горизонтальный поворотный душевой кронштейн стена 1/2"35 cm



60 181

Brazo ducha techo redondo 1/2" 20 cm
Round ceiling arm 1/2" 20 cm
Bras de douche vertical ronde 1/2" 20 cm
Runder deck träger. 1/2" x 20 cm
Вертикальный душевой кронштейн 1/2" 20 cm



60 182

Brazo ducha pared cuadrado 1/2" 35 cm
Square wall arm 1/2" 35 cm
Bras de douche sortie mural carré 1/2" 35 cm
Quadrat wandträger. 1/2" 35 Cm
Горизонтальный душевой кронштейн 1/2"35 cm



60 183

Brazo ducha techo cuadrado 1/2" 20 cm
Square ceiling arm 1/2" 20 cm
Bras de douche carré vertical 1/2" 20 cm
Quadrat deck träger. 1/2" 20 Cm
Вертикальный душевой кронштейн 1/2"20 cm



60 120

Toma 1/2" - 1/2" cilíndrica
Round wall outlet 1/2" - 1/2"
Coude sortie d'eau ronde 1/2" - 1/2"
Runder anchluss 1/2" - 1/2"
Соединитель 1/2"-1/2" цилиндр



60 121

Toma 1/2" - 1/2" cilíndrica con soporte
Round wall outlet 1/2" - 1/2" with support
Coude sortie d'eau ronde 1/2" - 1/2" avec support
Runder brausehalter anchluss 1/2" - 1/2"
Соединитель 1/2"-1/2" цилиндр с держателем для душевой



60 122

Toma 1/2" - 1/2" cuadrada
Square wall outlet 1/2" - 1/2"
Coude sortie d'eau carré 1/2" - 1/2"
Quadrat anchluss 1/2" - 1/2"
соединитель 1/2"-1/2" квадратный



60 123

Toma 1/2" - 1/2" cuadrada con soporte
Square wall outlet 1/2" - 1/2" with support
Coude sortie d'eau carré 1/2" - 1/2" avec support
Quadrat brausehalter anchluss 1/2" - 1/2"
Соединитель 1/2"-1/2" квадратный с держателем для душевой



- A** 40016 CR
Llave de paso empotrar 1/2"
Built-in key step 1/2"
- B** 40320/330/340/350 CR
Distribuidor empotrar 2/3/4/5 salidas
Built-in diverter 2/3/4/5 ways
- C** 60121 CR
Toma 1/2" - 1/2" cilíndrica con soporte
Round Wall outlet 1/2"-1/2" with support
- D** 21097 CR
Flexo 1,70 m pvc
Flexible hose 1,70 m pvc
- E** 21132 CR
Ducha teléfono ABS Mini Star
Hand shower ABS Mini Star



60 141 ●●●●●●●●●●

Jet lateral de ducha orientable 42X33 mm cuadrado
Orientable square lateral body jet 42X33 mm
Body jet latéral orientable carré 42X33 mm
Seitenbrause ausrichtbar 42X33 eckig
Квадратная регулируемая боковая форсунка 42X33 mm



60 140 ●●●●●●●●●●

Jet lateral de ducha orientable Ø 50 mm redondo
Orientable round lateral body jet Ø 50 mm
Body jet latéral orientable ronde Ø 50 mm
Seitenbrause ausrichtbar Ø 50 mm rund
Круглая регулируемая боковая форсунка Ø 50 mm

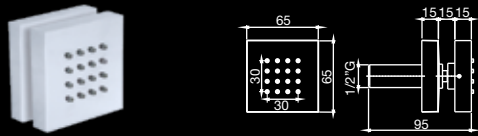

60 145 ●●●●●●●●●●

Jet lateral de ducha orientable 65X65 mm cuadrado
Orientable square lateral body jet 65x65 mm
Body jet latéral orientable carré 65x65 mm
Seitenbrause ausrichtbar 65x65 eckig
Квадратная регулируемая боковая форсунка 65x65 mm

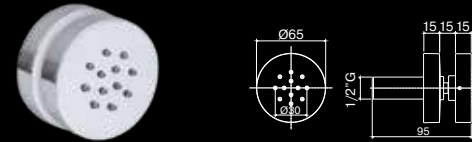

60 144 ●●●●●●●●●●

Jet lateral de ducha orientable Ø 65 mm redondo
Orientable round lateral body jet Ø 65 mm
Body jet latéral orientable ronde Ø 65 mm
Seitenbrause ausrichtbar Ø 65 mm rund
Круглая регулируемая боковая форсунка Ø 65 mm

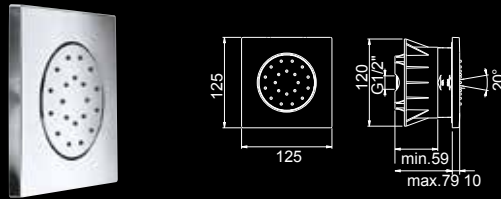

60 149 ●●●●●●●●●●

Jet lateral de ducha orientable 125x125 mm cuadrado
Orientable square lateral body jet 125x125 mm
Body jet latéral orientable carré 125x125 mm
Seitenbrause ausrichtbar 125x125 eckig
Квадратная регулируемая боковая форсунка 125x125mm

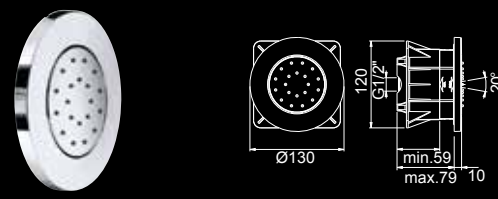

60 148 ●●●●●●●●●●

Jet lateral de ducha orientable Ø 130 mm redondo
Orientable round lateral body jet Ø 130 mm
Body jet latéral orientable ronde Ø 130 mm
Seitenbrause ausrichtbar Ø 130 mm rund
Круглая регулируемая боковая форсунка Ø 130 mm

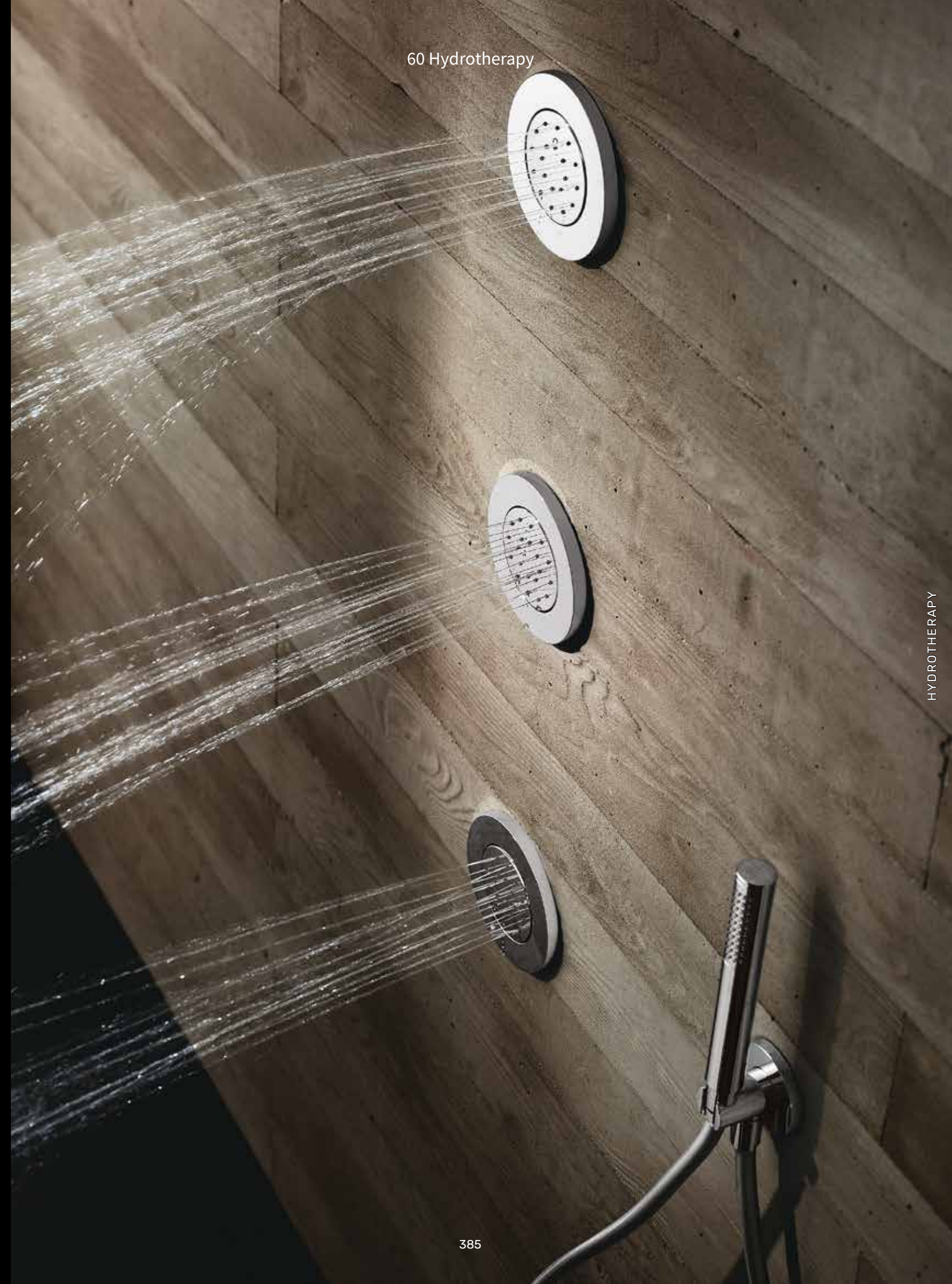
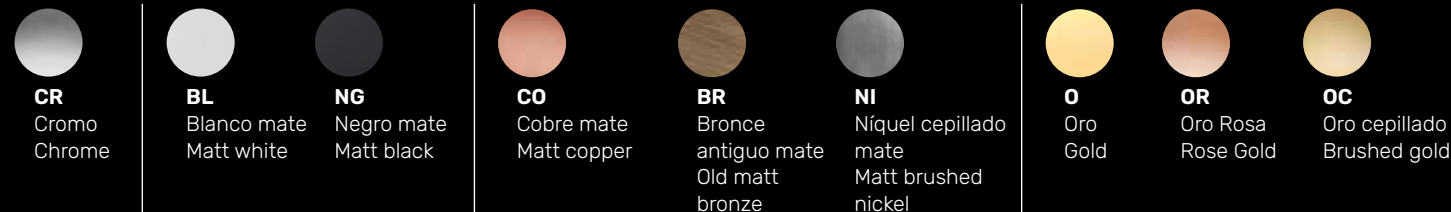

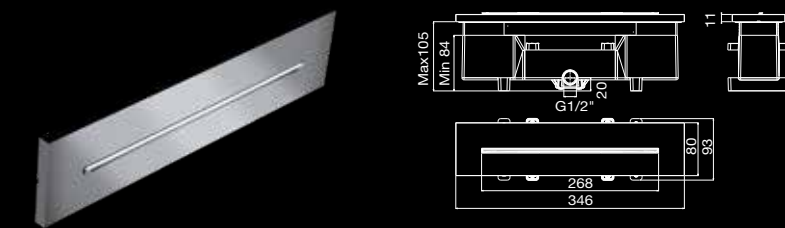

60 C400 ●●●●●●●●
 Rociador cascada empotrado a pared inox 350 mm
 Waterfall concealed inox showerhead wall mounted 350 mm
 встроенная душевая лейка нержавеющей эффект каскада 350 мм

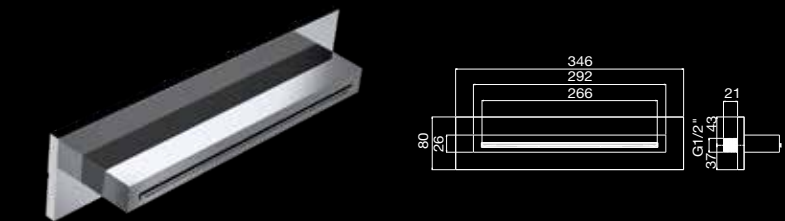

60 C401 ●●●●●●●●
 Rociador cascada a pared inox 350x53 mm
 Waterfall inox showerhead wall mounted 350x53 mm
 Настенная душевая лейка нержавеющей эффект каскада 350 x 53 mm



60 C403 ●●●●●●●●
 Rociador cascada a pared inox 240x140 mm
 Waterfall inox showerhead wall mounted 240x140 mm
 Настенная душевая лейка нержавеющей эффект каскада 200x140 mm.

- | | | | | | | |
|------------------------------|--|---------------------------------------|---|-------------------------|------------------------------------|--|
| | | | | | | |
| CR
Cromo
Chrome | BL
Blanco mate
Matt white | NG
Negro mate
Matt black | NI
Níquel cepillado mate
Matt brushed nickel | O
Oro
Gold | OR
Oro Rosa
Rose Gold | OC
Oro cepillado
Brushed gold |



- A** 60 C401 CR
Rociador cascada a pared inox 350x53 mm
Waterfall inox showerhead wall mounted 350x53 mm
- B** 43 312 CR
Monomando empotrar baño ducha
Built-in bath shower mixer
- C** 60 121 CR
Toma 1/2"- 1/2" cilíndrica con soporte
Round wall outlet 1/2"-1/2" with support
- D** 21 097 CR
Flexo 1,70 m pvc
Flexible hose 1,70 m pvc
- E** 21 136 CR
Ducha hidromasaje 2 jets con pulsador D 120 mm
Hand shower hydromassage 2 sprays with push button D120 mm



A 80D400 CO
Rociador para falso techo D400 mm
False ceiling showerhead D400 mm

B 43314 CO
Conjunto monomando baño/ducha empotrado 3 vías con caño, toma con soporte, ducha y flexo 1,70 m
Concealed bath shower set with shower mixer 1-way, diverter 3 ways, wall outlet with support, handshower and flexible hose 1.70 m

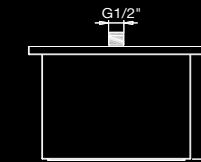
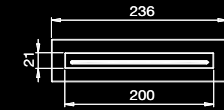

60 163 ●●●●●●●●●●

Caño bañera a pared cascada inox 240x140 mm
Waterfall bath spout inox wall mounted inox 240x140 mm
Настенный излив эффект каскада 240x140 mm.

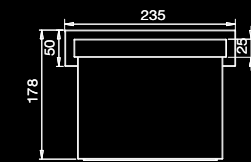
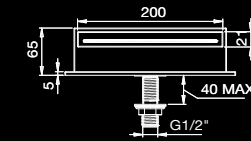

60 167 ●●●●●●●●●●

Caño bañera sobre repisa cascada inox 235x178 mm
Waterfall bath inox spout deck mounted 235x178 mm
Излив на борт ванны эффект каскада 235x178 mm



60 160 ●●●●●●●●●●

Caño bañera mural redondo 1/2"
Round wall bath tub spout 1/2"
Bec fondu pour baignoire 1/2" ronde
Runder wannenauslauf 1/2"
Поворотный излив настенный круглый 1/2"

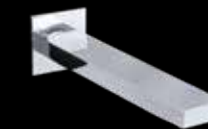

60 161 ●●●●●●●●●●

Caño bañera mural cuadrado 1/2"
Square wall bath tub spout 1/2"
Bec fondu pour baignoire carré 1/2"
Quadrat wannenauslauf 1/2"
Поворотный излив настенный квадратный 1/2"



CR
Cromo
Chrome



BL
Blanco mate
Matt white



NG
Negro mate
Matt black



CO
Cobre mate
Matt copper



BR
Bronce antiguo mate
Old matt bronze



NI
Níquel cepillado mate
Matt brushed nickel



O
Oro
Gold



OR
Oro Rosa
Rose Gold



OC
Oro cepillado
Brushed gold

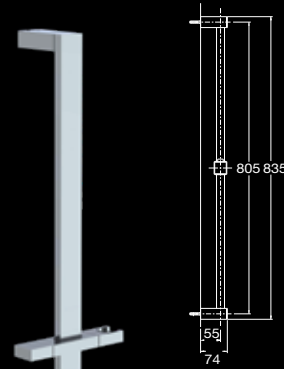

21 114 ●●●●●●●●●●

Barra deslizante de ducha cuadrada latón
Shower sliding bar square brass
Barre de douche glissant carrée laiton
Brausestange Quadrat messing
Душевая штанга квадратная из латуни



21 124 ●●●●●●●●●●

Kit barra deslizante de ducha cuadrada latón con flexo 1,70m y ducha de mano
Shower sliding bar square brass kit
Barre de douche glissant carrée laiton ensemble
Brausestange Quadrat messing set
Душевая штанга квадратная из латуни с шлангом 1,70 м и с ручным душем

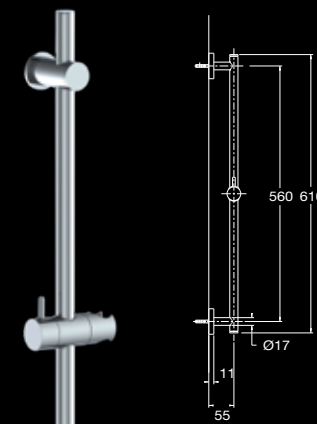

21 118 ●●●●●●●●●●

Barra deslizante de ducha redonda latón
Shower sliding bar round brass
Barre de douche glissant laiton ronde
Brausestange runden messing
Душевая штанга круглая из латуни

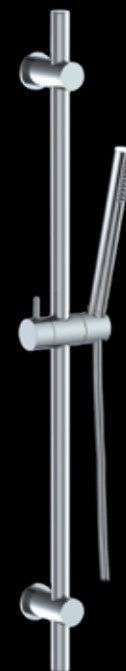

21 128 ●●●●●●●●●●

Kit barra deslizante de ducha redonda latón con flexo 1,70m y ducha de mano
Shower sliding bar round brass kit
Barre de douche glissant ronde laiton ensemble
Brausestange runden messing set
Душевая штанга круглая из латуни с шлангом 1,70 м и с ручным душем

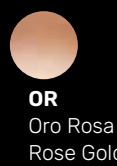
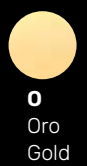

- A 80 K502 OC**
Rociador para falso techo 550x400 mm con 2 funciones: lluvia y cascada. Instalar con un grifo de 2 vías.
False ceiling 550x400mm showerhead with 2 functions: rainfall and waterfall. Install with a 2-way mixer.
- B 74 330 OC**
Distribuidor empotrar 3 salidas
Built-in diverter 3 ways
- C 74 315 OC**
Monomando empotrar ducha
Built-in shower mixer
- D 60 122 OC**
Toma 1/2" - 1/2" cuadrada
Square wall outlet 1/2" - 1/2"
- E 21 097 OC**
Flexo 1,70 m pvc
Flexible hose 1,70 m pvc
- F 21 134 OC**
Ducha teléfono latón Kuadrat
Hand shower brass Kuadrat
- G 21 114 OC**
Barra deslizante de ducha cuadrada latón
Shower sliding bar square brass

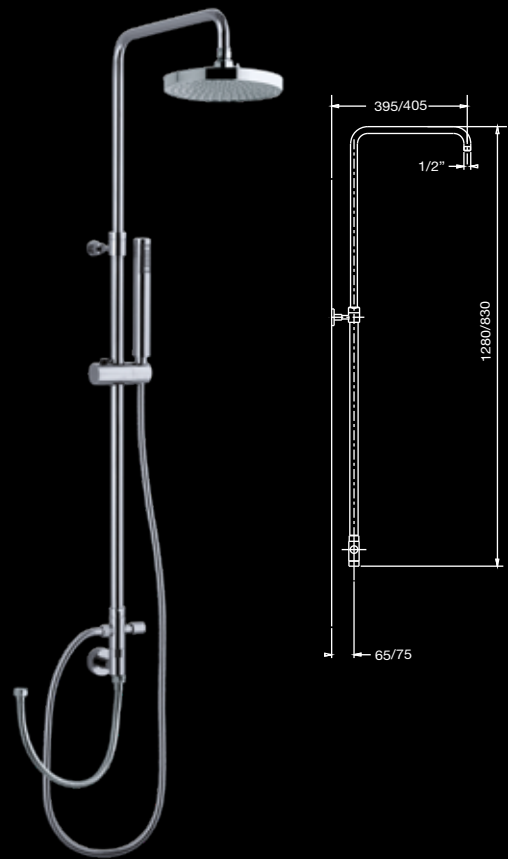

60 415-D200 ●●●●●●●●●●

Columna ducha cilíndrica telescópica con rociador D200 con desviador
 Round telescopic shower column with showerhead D200 with diverter
 Barre de douche ronde télescopique avec pomme de douche D200 et inverseur
 Runde brausegarnitur D200 mm bewegliche kopfbrause handbrause, brausehalter und umschalter
 Душевая колонна цилиндрическая телескопическая с дивертор и с верхним душем D200

60 415-D300 ●●●●●●●●●●

Columna ducha cilíndrica telescópica con rociador D300 con desviador
 Round telescopic shower column with showerhead D300 with diverter
 Barre de douche ronde télescopique avec pomme de douche D300 et inverseur
 Runde brausegarnitur D300 bewegliche kopfbrause handbrause, brausehalter und umschalter
 Душевая колонна цилиндрическая телескопическая с дивертор и с верхним душем D300



43 415-D200 ●●●●●●●●●●

Conjunto termostático con columna ducha cilíndrica telescópica y rociador D200
 Thermostatic and round telescopic shower column unit with showerhead D200
 Mitigeur thermostatique et barre de douche ronde télescopique avec pomme de douche D200
 Thermostat brausegarnitur runde brausegarnitur D200 mm bewegliche kopfbrause, Handbrause und brausehalter
 Термостатический душевой комплект с колонной цилиндрической телескопической, с верхним душем D200

43 415-D300 ●●●●●●●●●●

Conjunto termostático con columna ducha cilíndrica telescópica y rociador D300
 Thermostatic and round telescopic shower column unit with showerhead D300
 Mitigeur thermostatique et barre de douche ronde télescopique avec pomme de douche D300
 Thermostat brausegarnitur runde brausegarnitur D300 bewegliche kopfbrause, Handbrause und brausehalter
 Термостатический душевой комплект с колонной цилиндрической телескопической, с верхним душем D300

***43 413-D200/D300** ●●●●●●●●●●

Con grifo monomando
 With single-lever mixer

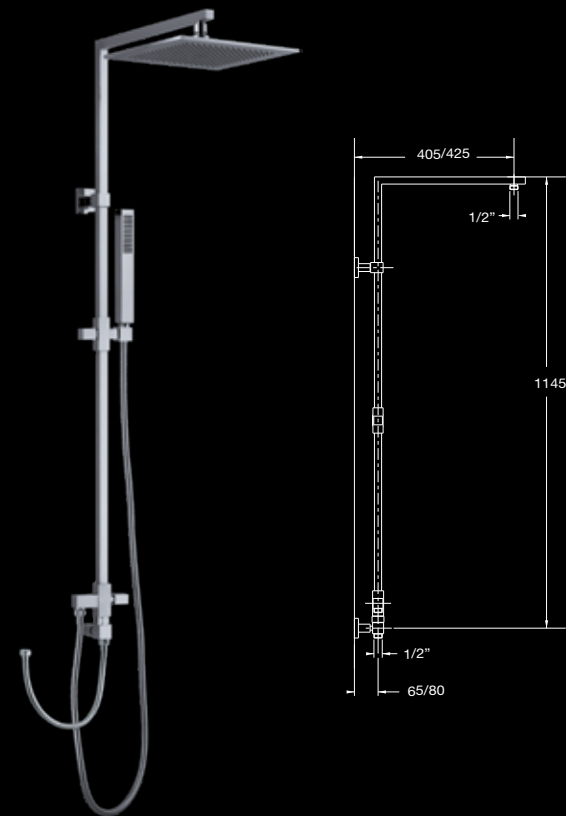

60 417-K200 ●●●●●

Columna ducha cuadrada con rociador K200 con desviador
 Square shower column with showerhead K200 with diverter
 Barre de douche carré avec pomme de douche K200 et inverseur
 Quadrat brausegarnitur. Quadrat K200 kopfbrause handbrause, brausehalter und umschalter
 Душевая колонна квадратная с дивертор и с верхним душем K200

60 417-K300 ●●●●●

Columna ducha cuadrada con rociador K300 con desviador
 Square shower column with showerhead K300 with diverter
 Barre de douche carré avec pomme de douche K300 et inverseur
 Quadrat brausegarnitur. Quadrat K300 kopfbrause handbrause, brausehalter und umschalter
 Душевая колонна квадратная с дивертор и с верхним душем K300

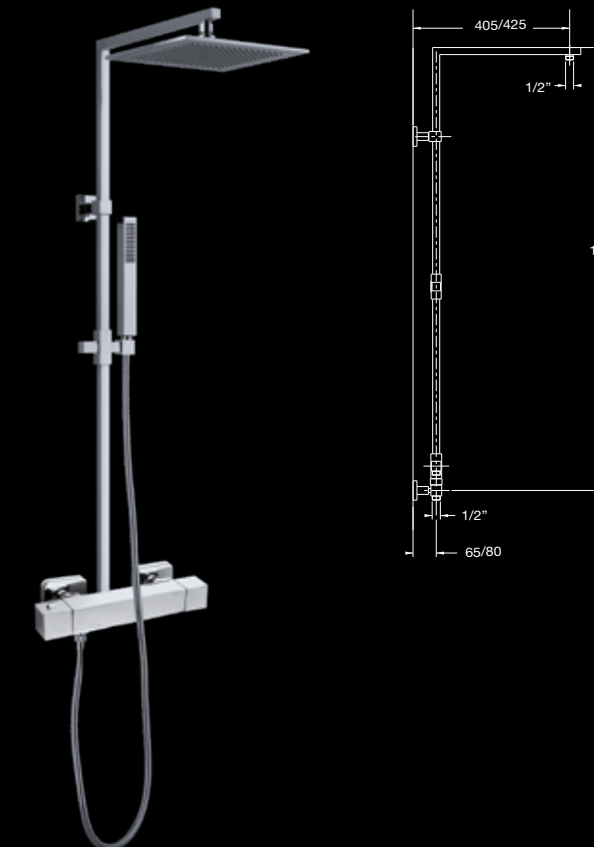

48 417-K200 ●●●●●

Conjunto termostático con columna ducha cuadrada telescópica y rociador K200
 Thermostatic and square telescopic shower column unit with showerhead K200
 Mitigeur thermostatique et barre de douche carré télescopique avec pomme de douche K200
 Thermostat brausegarnitur. Quadrat brausegarnitur K200 bewegliche kopfbrause, Handbrause und brausehalter
 Термостатический душевой комплект с колонной квадратной телескопической, с верхним душем K200

48 417-K300 ●●●●●

Conjunto termostático con columna ducha cuadrada telescópica y rociador K300
 Thermostatic and square telescopic shower column unit with showerhead K300
 Mitigeur thermostatique et barre de douche carré télescopique avec pomme de douche K300
 Thermostat brausegarnitur. Quadrat brausegarnitur K300 bewegliche kopfbrause, Handbrause und brausehalter
 Термостатический душевой комплект с колонной квадратной телескопической, с верхним душем K300

***48 413-K200 / K300** ●●●●●

Con grifo monomando
 With single-lever mixer





43 512 0
Grifo exento baño/ducha 1150 mm redondo con accesorios
Floorstanding bath/shower mixer 1150 mm round with accessories

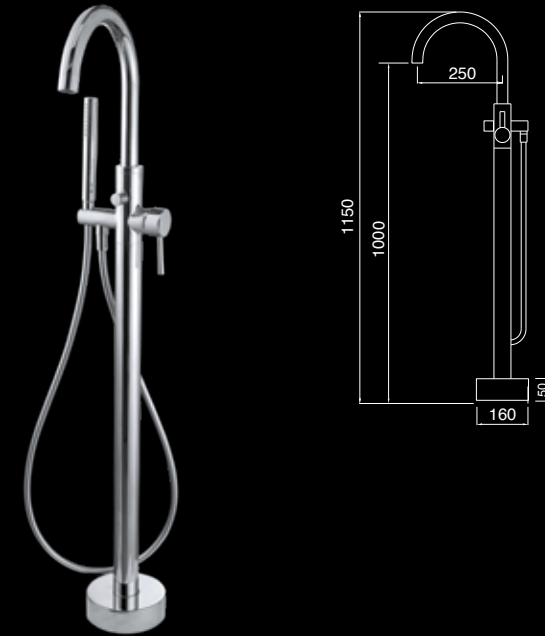

43 512 ●●●●●●●●●●

Grifo exento baño/ducha 1150 mm redondo con accesorios
Floorstanding bath/shower mixer 1150 mm round with accessories
Mitigeur colonne bain/douche 1150 mm rond avec accessoires
Freistehende wasserhanmischer bad/dusche 1150 mm rund mit zubehör
напольный смеситель для ванны 1150 мм круглый с лейкой



48 512 ●●●●●●●●●●

Grifo exento baño/ducha 920 mm cuadrado con accesorios
Floorstanding bath/shower mixer 920 mm square with accessories
Mitigeur colonne bain/douche 920 mm carré avec accessoires
Freistehende wasserhanmischer bad/dusche 920 mm eckig mit zubehör
напольный смеситель для ванны 920 мм квадратный с лейкой

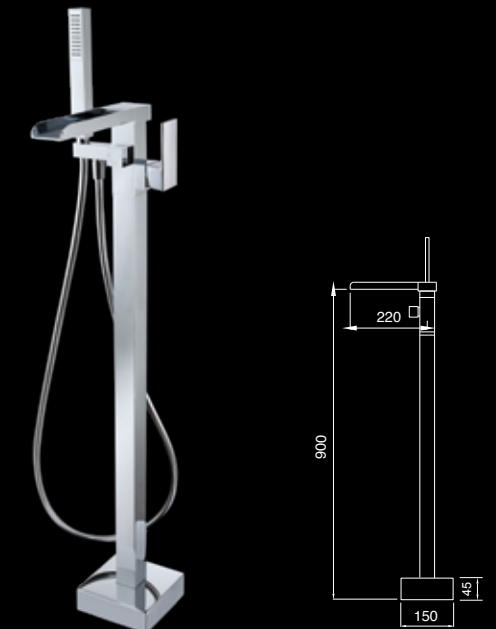

48 520 ●●●●●

Grifo exento baño/ducha 900 mm cuadrado caño cascada con accesorios
Floorstanding bath/shower mixer 900 mm square cascade spout with accessories
Mitigeur colonne bain/douche 900 mm carré bec cascade avec accessoires
Freistehende wasserhanmischer bad/dusche 900 mm eckig mit kaskade und zubehör
напольный смеситель для ванны 900 мм квадратный с лейкой и изливом каскад

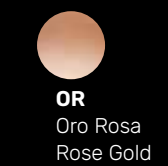
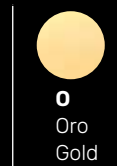
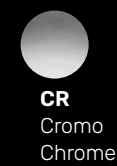



43 800 ●●●●●●●●●●

Monomando bidé empotrado con soporte, duchita y flexo 1,25 m
 Concealed single-lever bidet set with support, shut-off handshower and flexible hose 1,25 m
 Mitigeur de bidet à encastrer avec support, douchette et flexible 1,25 m
 Unterputz Bidet Einhandmischer mit Handbrause und flexiblem Schlauch 1,25 m
 Встроенный смеситель для гигиенического душа с ручной лейкой и гибким шлангом 1,25м



48 800 ●●●●●●●●●●

Monomando bidé empotrado con soporte, duchita y flexo 1,25 m
 Concealed single-lever bidet set with support, shut-off handshower and flexible hose 1,25 m
 Mitigeur de bidet à encastrer avec support, douchette et flexible 1,25 m
 Unterputz Bidet Einhandmischer mit Handbrause und flexiblem Schlauch 1,25 m
 Встроенный смеситель для гигиенического душа с ручной лейкой и гибким шлангом 1,25м



21 800 ●●●●●●●●●●

Kit duchita redondo, flexo EPDM 1,20 m, llave de cierre cerámico y soporte
 Round shut-off hand shower set, EPDM flexible hose of 1,20 m, angle valve with ceramic headwork and support
 Ensemble douchette ronde, flexible de douche EPDM 1,20 m, robinet d'arrêt ceramique et support murale
 Set runde messing bidet duschset und wasserhahn
 Набор гигиенического душа круглый с гибким шлангом EPDM 1,20 м и с держателем, керамический запорный кран



21 900 ●●●●●●●●●●

Kit duchita cuadrado, flexo EPDM 1,20 m, llave de cierre cerámico y soporte
 Square shut-off hand shower set, EPDM flexible hose of 1,20 m, angle valve with ceramic headwork and support
 Ensemble douchette carré, flexible de douche EPDM 1,20 m, robinet d'arrêt ceramique et support murale
 Set quadrat messing bidet duschset und wasserhahn
 Набор гигиенического душа квадратный с гибким шлангом EPDM 1,20 м и с держателем, керамический запорный кран



21 523 ●●●●●●●●●●

Grifo de 1 agua bidé con soporte, duchita higiénica y flexo 1,20 m
 Tap 1 water bidet set with support, shut-off handshower and flexible hose 1,20 m
 Ensemble avec robinet 1 eau avec support, douchette ronde, flexible 1,20 m
 Set runde messing bidet duschset, wasserhahn und 1,20 m flexiblen
 Гигиенический душ с запорным краном



21 136 ●●●●●●●●●●

Ducha hidromasaje 2 jets con pulsador D 120 mm
 Hand shower hydromassage 2 sprays with push button D120 mm
 Douchette hydromassage 2 jets D120 mm
 Handbrause hydromassage 2 sprays D120 mm
 Ручной душ гидромассаж 2 струй D120 mm



21 135 ●●●●●●●●●●

Ducha hidromasaje 3 jets D112 mm
 Hand shower hydromassage 3 sprays D112 mm
 Douchette hydromassage 3 jets D112 mm
 Handbrause hydromassage 3 sprays D112 mm
 Ручной душ гидромассаж 3 струй D112 mm



21 134 ●●●●●●●●●●

Ducha teléfono latón Kuadrat
 Hand shower brass Kuadrat
 Douchette Kuadrat laiton
 Kuadrat handbarause messing
 Ручная лейка-телефон из латуни Квадрат



21 133 ●●●●●●●●●●

Ducha teléfono ABS Kuadrat
 Hand shower ABS Kuadrat
 Douchette Kuadrat
 Kuadrat handbarause
 Ручная лейка-телефон ABS Квадрат



21 132 ●●●●●●●●●●

Ducha teléfono ABS Mini Star
 Hand shower ABS Mini Star
 Douchette Mini Star
 Mini Star handbarause
 Лейка-телефон ABS Мини Стар

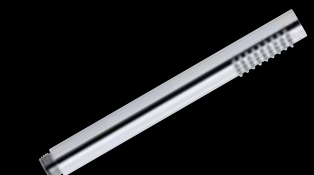

21 139 ●●●●●●●●●●

Ducha teléfono Mini Star latón
 Hand shower Mini Star brass
 Douchette Mini Star laiton
 Mini Star handbarause messing
 Лейка-телефон Мини Стар латунь



21 131 ●●●●●●●●●●

Ducha teléfono Memory
 Hand shower Memory
 Douchette Memory
 Memory handbarause
 Ручная лейка- телефон Мемори



21 141 ●●●●●●●●●●

Ducha Teléfono Memory Latón
 Hand Shower Memory Brass
 Douchette Memory Laiton
 Memory Handbarause Messing
 Ручная лейка- телефон из латуни Мемори



21 101 ●●●●●●●●●●

Flexo 1,70 m latón
 Flexible hose 1,70 m brass
 Connexion flexible 1,70 m laiton
 1,70 m flexiblen schlauch
 душевой шланг 1,70 м латунь



21 097 ●●●●●●●●●●

Flexo 1,70 m PVC
 Flexible hose 1,70 m PVC
 Connexion flexible 1,70 m PVC
 1,70 m flexiblen PVC
 душевой шланг 1,70 m PVC



21 096 ●●●●●●●●●●

Flexo 1,20 m PVC
 Flexible hose 1,20 m PVC
 Connexion flexible 1,20 m PVC
 1,20 m flexiblen PVC
 душевой шланг 1,20 m PVC

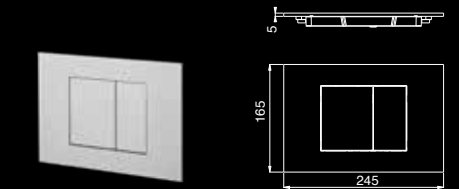

21 650 ●●●●●●●●●●

Placa pulsador wc
 Flush plate wc
 Plaque de déclenchement wc
 Betätigungsplatte für wc
 Клавиша смыва

Compatible con/with: GEBERIT & TECE



CR
 Cromo
 Chrome



BL
 Blanco mate
 Matt white



NG
 Negro mate
 Matt black



CO
 Cobre mate
 Matt copper



BR
 Bronce antiguo mate
 Old matt bronze



NI
 Níquel cepillado mate
 Matt brushed nickel



O
 Oro
 Gold



OR
 Oro Rosa
 Rose Gold



OC
 Oro cepillado
 Brushed gold

26 Mini Star accessories



Mini Star accessories



El timón fluido
The fluid helm



CR
Cromo
Chrome
Chrome
Chrom
Хром



NG
Negro mate
Matt black
Noir mate
Schwarz matte
Черное



BL
Blanco mate
Matt white
Blanche mate
Weisse matte
Белое



CO
Cobre mate
Matt copper
Cuivre mat
Kupfer matt
Матовая медь



BR
Bronce antiguo mate
Old matt bronze
Vieux bronze mat
Altes bronze matt
Матовая состаренная
бронза



NI
Níquel cepillado mate
Matt brushed nickel
Matt brossé nickel
Matt gebürstetes Nickel
Брашированный матовый
никел



O
Oro
Gold
Or
Gold
Золото



OR
Oro rosa
Rose gold
Or rosé
Rose Gold
Розовое золото



OC
Oro cepillado
Brushed gold
Or brossé
Gebürstetes gold
Брашированное золото



26 006 CR
Portavaso pared cristal
Tumbler holder

26 004S CR
Toallero barra 30 cm.
Towel bar small 30 cm.



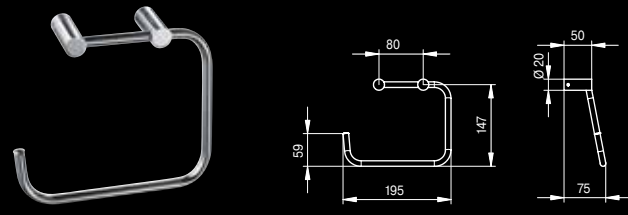

26 002 ●●●●●●●●●●●●●●●●

Toallero aro
Towel ring
Anneau porte-serviette
Handtuchring
Кольцо для полотенца

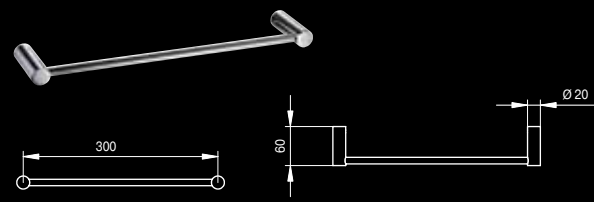

26 004S ●●●●●●●●●●●●●●●●

Toallero barra 30 cm.
Towel bar small 30 cm.
Porte-serviette 30 cm.
Handtuchstange 30 cm.
Держатель для полотенца маленький 30 cm.

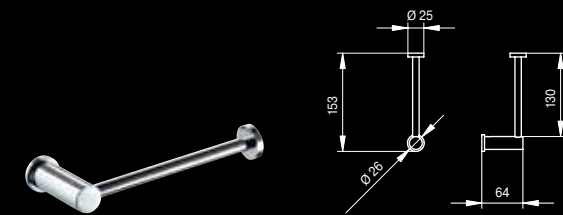

26 011 ●●●●●●●●●●●●●●●●

Portarrollos lateral
Roll holder
Porte-papier
Papierrollenhalter
Бумагодержатель

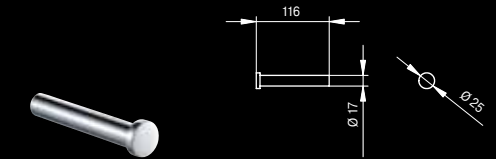

26 031 ●●●●●●●●●●●●●●●●

Portarrollos
Roll holder
Porte-papier
Papierrollenhalter
Бумагодержатель

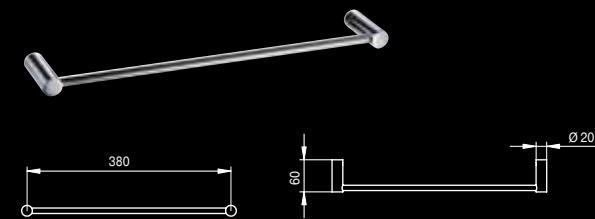

26 004M ●●●●●●●●●●●●●●●●

Toallero barra 40 cm.
Towel bar medium 40 cm.
Porte-serviette 40 cm.
Handtuchstange 40 cm.
Держатель для полотенца средний 40cm.

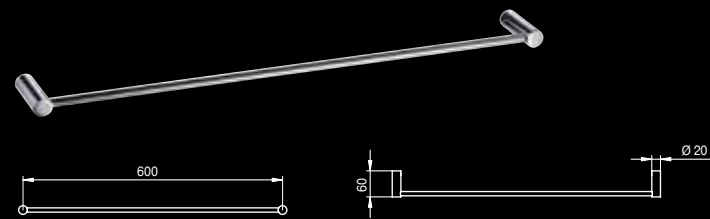

26 004L ●●●●●●●●●●●●●●●●

Toallero barra 60 cm.
Towel bar large 60 cm.
Porte-serviette 60 cm.
Handtuchstange 60 cm.
Держатель для полотенца большой 60 cm.

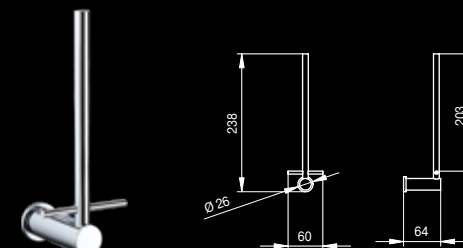

26 021 ●●●●●●●●●●●●●●●●

Portarrollos reserva vertical
Roll holder reserve vertical
Support pour rouleau de réserve
Reserve papierrollerhalter
Вертикальный Бумагодержатель



26 114 ●●●●●●●●●●●●●●●●

Toallero redondo 60 cm.
Round towel rack 60 cm.
Porte-serviettes ronde 60 cm.
Handtuchregal rund 60 cm.
Держатель для полотенец круглый 60 cm.

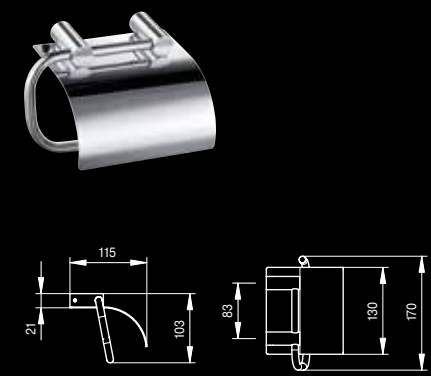

26 001 ●●●●●●●●●●●●●●●●

Portarrollos con tapa
Roll holder with cover
Porte-papier avec couvercle
Wc-papierrollerhalter mit deckel
Бумагодержатель с крышкой

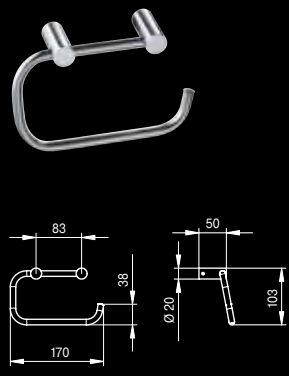

26 041 ●●●●●●●●●●●●●●●●

Portarrollos
Roll holder
Porte-papier
Papierrollenhalter
Бумагодержатель

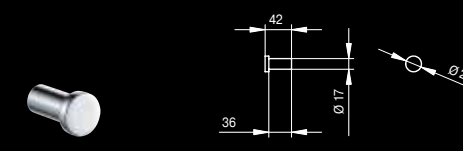

26 005 ●●●●●●●●●●●●●●●●

Percha
Wall hook
Porte-peignoir
Badenmantelhaken
Крючок на стену



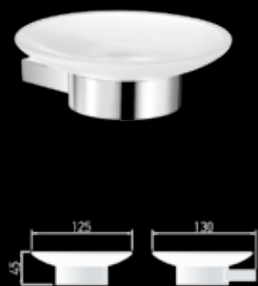

26 007 ●●●●●●●●●●

Jabobera a pared
Wall mounted soap holder
Porte-savon ronde mural
Seifenschale wand
Держатель стакана из стекла настенный



26 006 ●●●●●●●●●●

Portavaso pared cristal
Tumbler holder
Porte-verre mural
Wandglashalter
Стакан держатель

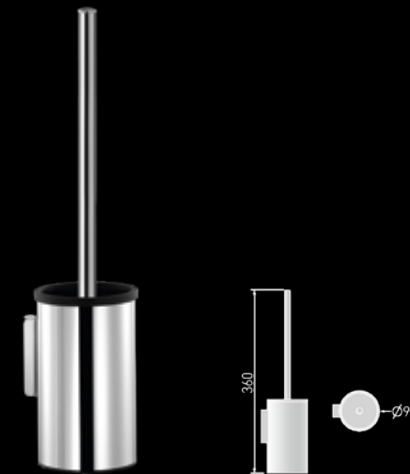

26 008 ●●●●●●●●●●

Portaescobillas a pared
Wall mounted brush holder
Pot a balai mural
Bürstengarnitur wand
Ершик настенный



26 208 ●●●●●●●●●●

Portarollos y portaescobillas de pie redondo
Round standing roll & brush holder
Porte-papier et pot a balai sur pied ronde
Freistehende toilettenbürste & halter rund
Напольный держатель бумаги и ершик круглый



26 009 ●●●●●●●●●●

Dispensador gel a pared
Wall mounted gel dispenser
Distributeur de savon liquide mural
Wand seifenspender
Диспенсер для геля настенный

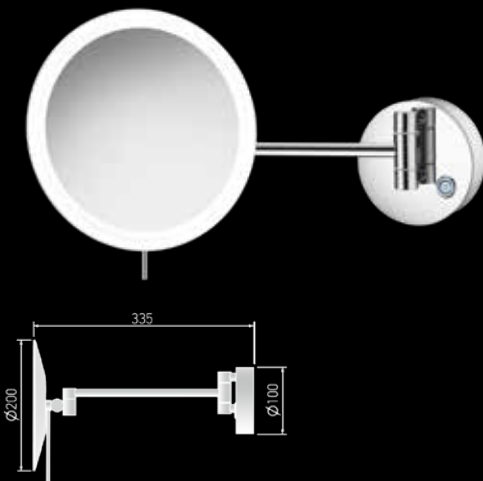

26 205 ●●●●●●●●●●

Espejo pared 1 brazo redondo x5 con luz led
Wall mounted round magnifying mirror x5 with led light
Miroir mural ronde grossissant x5 led lumineux
Wand-kosmetikspiegel rund mit led-beleuchtung 5 x vergrößerung
Увеличительное зеркало с подсветкой led настенное x5

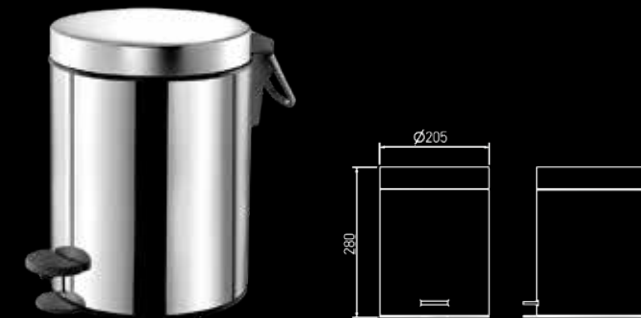

26 233 ●●●●●●●●●●

Cubo baño con tapa y pedal 5 litros
Pedal waste bin 5 liters
Corbeille a pedale 5 litres
Treteimer für bad 5 liter
Ведро для мусора с педалью и крышкой 5 л.

CR
Cromo
Chrome

NG
Negro mate
Matt black

BL
Blanco mate
Matt white

CO
Cobre mate
Matt copper

BR
Bronce antiguo mate
Old matt bronze

NI
Níquel cepillado mate
Matt brushed nickel

O
Oro
Gold

OR
Oro Rosa
Rose Gold

OC
Oro cepillado
Brushed gold

23 Ikon accessories



Ikon accessories



El prisma infinito.
The endless prism



CR
Cromo
Chrome
Chrome
Chrom
Хром



NG
Negro mate
Matt black
Noir mate
Schwarz matte
Черное



CO
Cobre mate
Matt copper
Cuivre mat
Kupfer matt
Матовая медь



O
Oro
Gold
Or
Gold
Золото



OR
Oro rosa
Rose gold
Or rosé
Rose Gold
Розовое золото



OC
Oro cepillado
Brushed gold
Or brossé
Gebürstetes gold
Брашированное золото



23 005 O / 23 005 OR / 23 005 CR
Percha
Wall hook

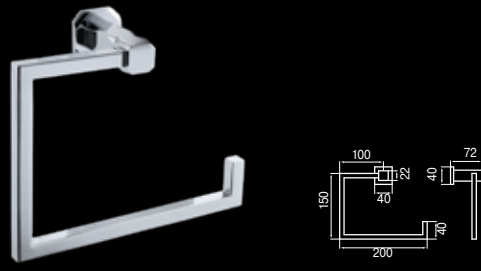

23 002 ●●●●●●●●

Toallero aro
Towel ring
Anneau porte-serviette
Handtuchring
Кольцо для полотенца



23 004S ●●●●●●●●

Toallero barra 30 cm.
Towel bar small 30 cm.
Porte-serviette 30 cm.
Handtuchstange 30 cm.
Держатель для полотенца маленький 30 cm.

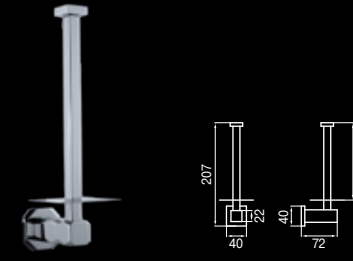

23 021 ●●●●●●●●

Portarrollos reserva vertical
Roll holder reserve vertical
Support pour rouleau de réserve
Reserve papierrollerhalter
Вертикальный Бумагодержатель

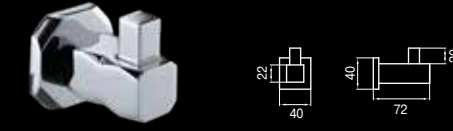

23 005 ●●●●●●●●

Percha
Wall hook
Porte-peignor
Badenmantelhaken
Крючок на стену



23 004M ●●●●●●●●

Toallero barra 40 cm.
Towel bar medium 40 cm.
Porte-serviette 40 cm.
Handtuchstange 40 cm.
Держатель для полотенца средний 40cm.



23 004L ●●●●●●●●

Toallero barra 60 cm.
Towel bar large 60 cm.
Porte-serviette 60 cm.
Handtuchstange 60 cm.
Держатель для полотенца большой 60 cm.



23 007 ●●●●●●●●

Jabonera pared cristal
Soap dish holder
Porte-savon mural
Seifenschale zur wandmontage
Мыльница



23 006 ●●●●●●●●

Portavasos pared cristal
Tumbler holder
Porte-verre mural
Wandglashalter
Стакан держатель



23 001 ●●●●●●●●

Portarrollos con tapa
Roll holder with cover
Porte-papier avec couvercle
Wc-papierrollerhalter mit deckel
Бумагодержатель с крышкой



23 011 ●●●●●●●●

Portarrollos lateral
Roll holder
Porte-papier
Papierrollenhalter
Бумагодержатель

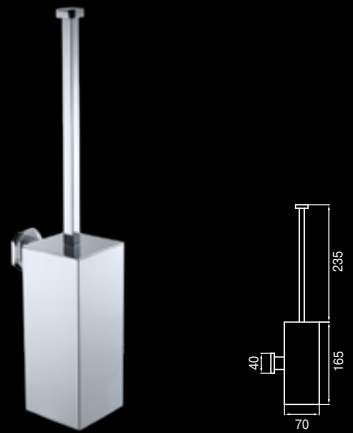

23 008 ●●●●●●●●

Portaescobillas a pared
Wall mounted brush holder
Ensemble pot à balai mural
Wc-bürstentopf-garnitur
Ершик настенный

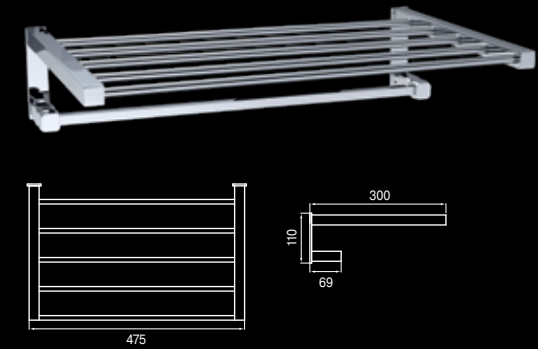

23 114 ●●●●●●●●

Toallero estante 50 cm
Towel holder stand 50 cm
Porte-serviettes 50 cm
Cadetuchhalter 50 cm
Держатель для полотенец квадратный 50 cm



12 Muse Diamond accessories

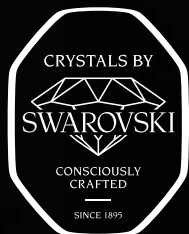



Swarovski® is a registered trademark

Muse Diamond accessories



Un flash deslumbrante.
A dazzling flash.

- 

CR
Cromo
Chrome
Chrome
Chrom
Хром
- 

O
Oro
Gold
Or
Gold
Золото
- 

OR
Oro rosa
Rose gold
Or rosé
Rose Gold
Розовое золото
- 

OC
Oro cepillado
Brushed gold
Or brossé
Gebürstetes gold
Брашированное золото



R RING CRYSTAL



F FULL CRYSTAL



C CERALUN CRYSTAL



R RING CRYSTAL

12 002R CR
Toallero aro
Towel ring



C CERALUN CRYSTAL

12 002C CR
Toallero aro
Towel ring



F FULL CRYSTAL

12 011F 0
Portarrollos lateral
Roll holder



12 002 R / F / C

Toallero aro
Towel ring
Anneau porte-serviette
Handtuchring
Кольцо для полотенца



12 004S R / F / C

Toallero barra 30 cm.
Towel bar small 30 cm.
Porte-serviette 30 cm.
Handtuchstange 30 cm.
Держатель для полотенца маленький 30 см.

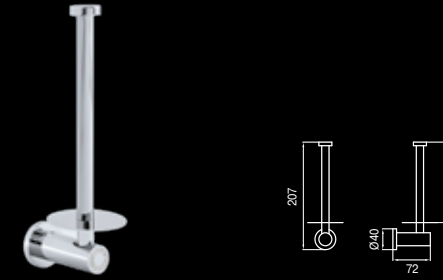

12 021 R / F / C

Portarrollos reserva vertical
Roll holder reserve vertical
Support pour rouleau de réserve
Reserve papierrollerhalter
Вертикальный Бумагодержатель



12 005 R / F / C

Percha
Wall hook
Porte-peignoir
Badenmantelhaken
Крючок на стену

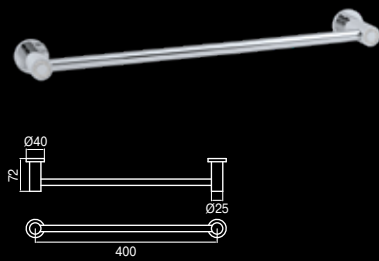

12 004M R / F / C

Toallero barra 40 cm.
Towel bar medium 40 cm.
Porte-serviette 40 cm.
Handtuchstange 40 cm.
Держатель для полотенца средний 40 см.

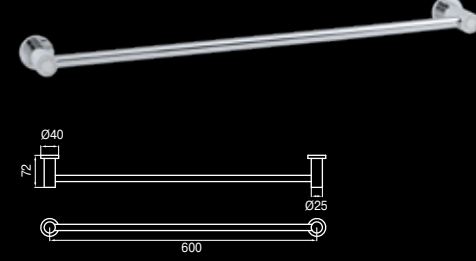

12 004L R / F / C

Toallero barra 60 cm.
Towel bar large 60 cm.
Porte-serviette 60 cm.
Handtuchstange 60 cm.
Держатель для полотенца большой 60 см.



12 007 R / F / C

Jabonera pared cristal
Soap dish holder
Porte-savon mural
Seifenschale zur wandmontage
Мыльница

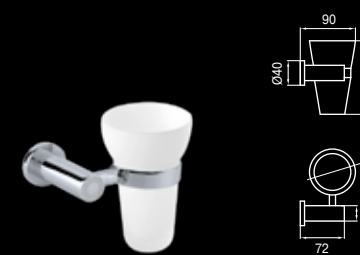

12 006 R / F / C

Portavasos pared cristal
Tumbler holder
Porte-verre mural
Wandglashalter
Стакан держатель



12 001 R / F / C

Portarrollos con tapa
Roll holder with cover
Porte-papier avec couvercle
Wc-papierrollerhalter mit deckel
Бумагодержатель с крышкой



12 011 R / F / C

Portarrollos lateral
Roll holder
Porte-papier
Papierrollenhalter
Бумагодержатель

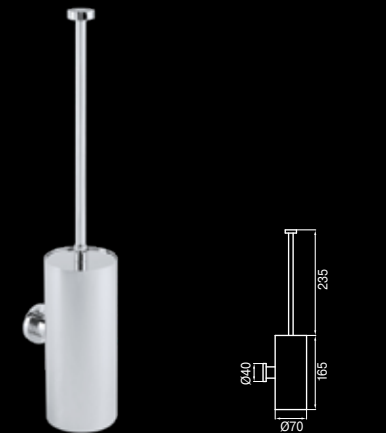

12 008 R / F / C

Portaescobillas a pared
Wall mounted brush holder
Ensemble pot à balai mural
Wc-bürstentopf-garnitur
Ёршик настенный

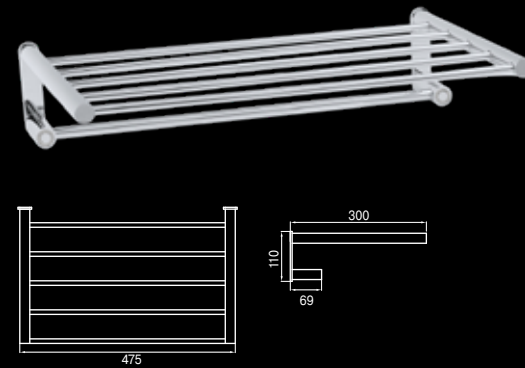

12 114 R / F / C

Toallero estante 50 cm.
Towel holder stand 50 cm.
Porte-serviettes 50 cm.
Cadetuchhalter 50 cm.
Держатель для полотенец 50 см.



20 Artik Round accessories



ACCESSORIES







Swarovski® is a registered trademark

Artik Round accessories



Un destello redondo
A round sparkle

- | | | | | | | | |
|---|---|---|---|---|--|---|---|
|  | CR
Cromo
Chrome
Chrome
Chrom
Хром |  | O
Oro
Gold
Or
Gold
Золото |  | OR
Oro rosa
Rose gold
Or rosé
Rose Gold
Розовое золото |  | OC
Oro cepillado
Brushed gold
Or brossé
Gebürstetes gold
Брашированное золото |
|---|---|---|---|---|--|---|---|



20 021 OR
Portarrollos reserva vertical
Roll holder reserve vertical

20 011 OR
Portarrollos lateral
Roll holder



20 002 ●●●●●

Toallero aro
Towel ring
Anneau porte-serviette
Handtuchring
Кольцо для полотенца



20 004S ●●●●●

Toallero barra 30 cm.
Towel bar small 30 cm.
Porte-serviette 30 cm.
Handtuchstange 30 cm.
Держатель для полотенца маленький 30 cm.

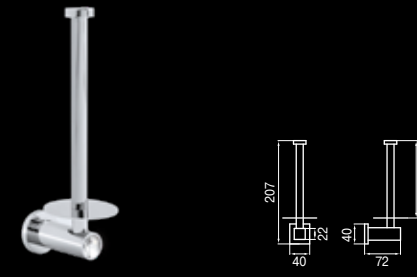

20 021 ●●●●●

Portarrollos reserva vertical
Roll holder reserve vertical
Support pour rouleau de réserve
Reserve papierrollerhalter
Вертикальный Бумагодержатель



20 005 ●●●●●

Percha
Wall hook
Porte-peignoir
Badenmantelhaken
Крючок на стену

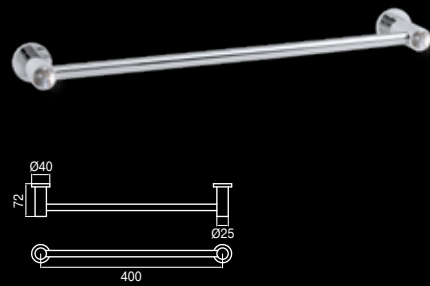

20 004M ●●●●●

Toallero barra 40 cm.
Towel bar medium 40 cm.
Porte-serviette 40 cm.
Handtuchstange 40 cm.
Держатель для полотенца средний 40cm.

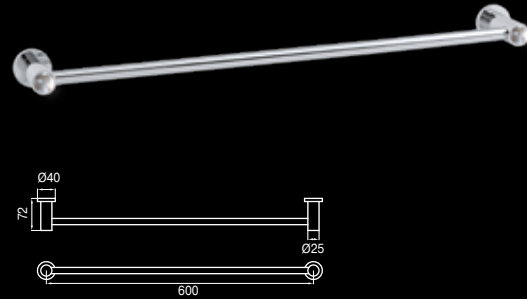

20 004L ●●●●●

Toallero barra 60 cm.
Towel bar large 60 cm.
Porte-serviette 60 cm.
Handtuchstange 60 cm.
Держатель для полотенца большой 60 cm.



20 007 ●●●●●

Jabonera pared cristal
Soap dish holder
Porte-savon mural
Seifenschale zur wandmontage
Мыльница



20 006 ●●●●●

Portavasos pared cristal
Tumbler holder
Porte-verre mural
Wandglashalter
Стакан держатель



20 001 ●●●●●

Portarrollos con tapa
Roll holder with cover
Porte-papier avec couvercle
Wc-papierrollerhalter mit deckel
Бумагодержатель с крышкой



20 011 ●●●●●

Portarrollos lateral
Roll holder
Porte-papier
Papierrollerhalter
Бумагодержатель

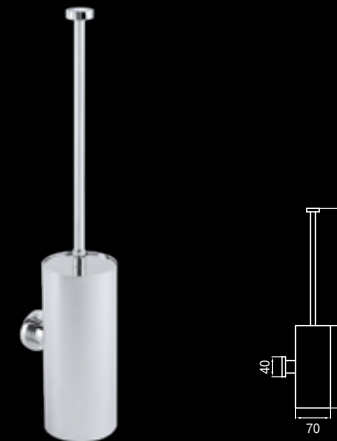

20 008 ●●●●●

Portaescobillas a pared
Wall mounted brush holder
Ensemble pot à balai mural
Wc-bürstentopfgarnitur
Ершик настенный

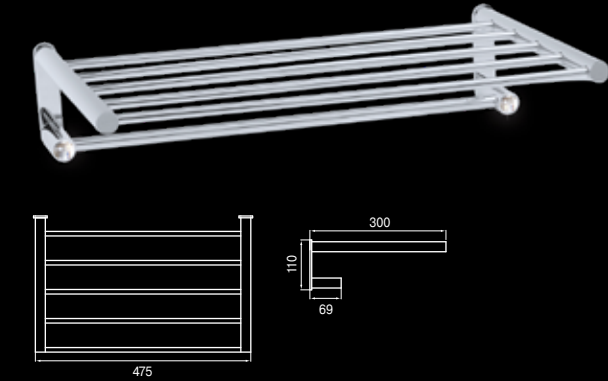

20 114 ●●●●●

Toallero estante 50 cm.
Towel holder stand 50 cm.
Porte-serviettes 50 cm.
Cadetuchhalter 50 cm.
Держатель для полотенец 50 cm.





27 **Kuadrat**
accessories

Kuadrat accessories



Geometría fiel
Faithful geometry



CR
Cromo
Chrome
Chrome
Chrom
Хром



NG
Negro mate
Matt black
Noir mate
Schwarz matte
Черное



CO
Cobre mate
Matt copper
Cuivre mat
Kupfer matt
Матовая медь



O
Oro
Gold
Or
Gold
Золото



OR
Oro rosa
Rose gold
Or rosé
Rose Gold
Розовое золото



OC
Oro cepillado
Brushed gold
Or brossé
Gebürstetes gold
Брашированное золото



27 208 O
Portarrollos y portaescobillas de pie cuadrado
Square standing roll & brush holder

27 004S O
Toallero barra 30 cm.
Towel bar small 30 cm.

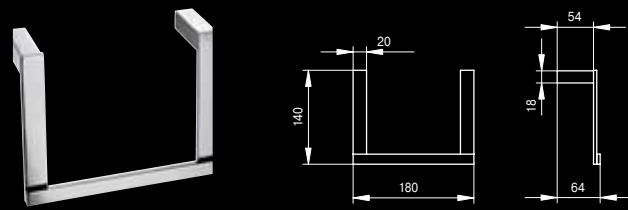

27 002 ●●●●●●●●

Toallero aro
Towel ring
Anneau porte-serviette
Handtuchring
Кольцо для полотенца

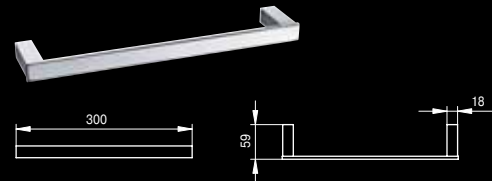

27 004S ●●●●●●●●

Toallero barra 30 cm.
Towel bar small 30 cm.
Porte-serviette 30 cm.
Handtuchstange 30 cm.
Держатель для полотенца маленький 30 cm.

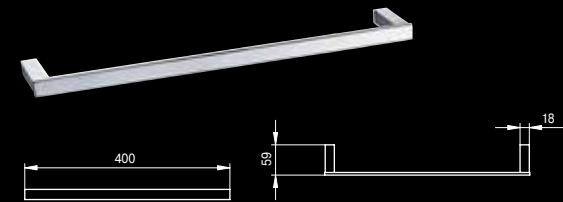

27 004M ●●●●●●●●

Toallero barra 40 cm.
Towel bar medium 40 cm.
Porte-serviette 40 cm.
Handtuchstange 40 cm.
Держатель для полотенца средний 40cm.

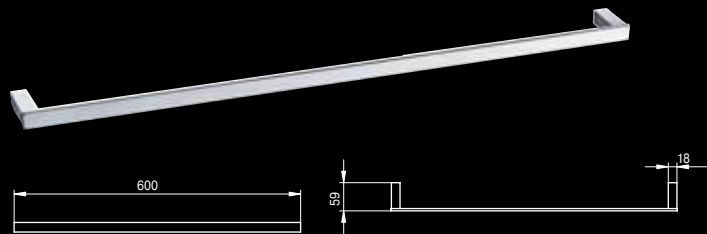

27 004L ●●●●●●●●

Toallero barra 60 cm.
Towel bar large 60 cm.
Porte-serviette 60 cm.
Handtuchstange 60 cm.
Держатель для полотенца большой 60 cm.

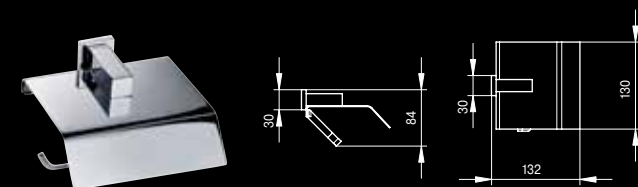

27 001 ●●●●●●●●

Portarrollos con tapa
Roll holder with cover
Porte-papier avec couvercle
Wc-papierrollerhalter mit deckel
Бумагодержатель с крышкой

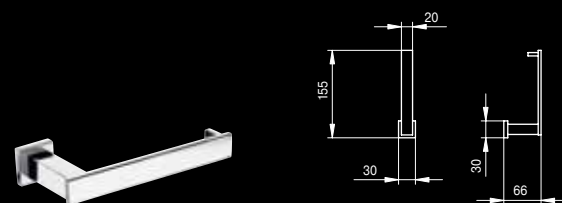

27 011 ●●●●●●●●

Portarrollos lateral
Roll holder
Porte-papier
Papierrollenhalter
Бумагодержатель

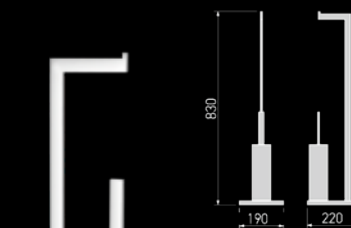

27 208 ●●●●●●●●

Portarrollos y portaescobillas de pie cuadrado
Square standing roll & brush holder
Porte-papier et pot a balai sur pied carré
Freistehende toilettenbürste & halter eckig
Напольный держатель бумаги и ершик квадратный

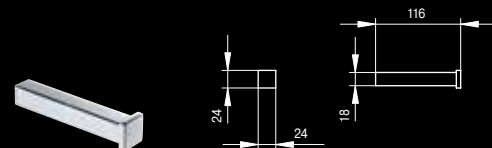

27 031 ●●●●●●●●

Portarrollos
Roll holder
Porte-papier
Papierrollenhalter
Бумагодержатель



27 021 ●●●●●●●●

Portarrollos reserva vertical
Roll holder reserve vertical
Support pour rouleau de réserve
Reserve papierrollerhalter
Вертикальный Бумагодержатель



27 005 ●●●●●●●●

Percha
Wall hook
Porte-peignoir
Badenmantelhaken
Крючок на стену



27 007 ●●●●●●●●

Jabobera a pared
Wall mounted soap holder
Porte-savon ronde mural
Seifenschale wand
Держатель стакана из стекла настенный



27 006 ●●●●●●●●

Portavasos pared cristal
Tumbler holder
Porte-verre mural
Wandglashalter
Стакан держатель



27 009 ●●●●●●●●

Dispensador gel a pared
Wall mounted gel dispenser
Distributeur de savon liquide mural
Wand seifenspender
Диспенсер для геля настенный



27 008 ●●●●●●●●

Escobillero a pared
Wall mounted brush holder
Pot a balai mural
Bürstengarnitur wand
Ершик настенный



27 114 ●●●●●●●●

Toallero cuadrado 60cm.
Square towel rack 60cm.
Porte-serviettes carré 60cm.
Handtuchregal eckig 60cm.
Держатель для полотенец квадратный 60 cm.

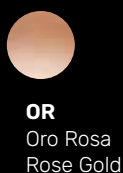
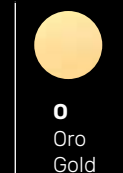
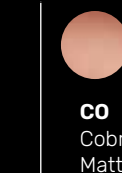
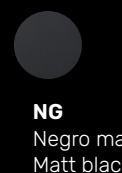
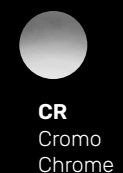



Swarovski® is a registered trademark





14 Skip Diamond accessories

Skip Diamond accessories



El brillo geométrico.
The gometric glint.

- 

CR
Cromo
Chrome
Chrome
Chrom
Хром
- 

O
Oro
Gold
Or
Gold
Золото
- 

OR
Oro rosa
Rose gold
Or rosé
Rose Gold
Розовое золото
- 

OC
Oro cepillado
Brushed gold
Or brossé
Gebürstetes gold
Брашированное золото



14 004S O
Toallero barra 30 cm
Towel bar medium 30 cm

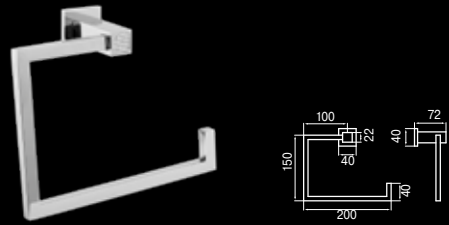

14 002 ●●●●●

Toallero aro
Towel ring
Anneau porte-serviette
Handtuchring
Кольцо для полотенца



14 004S ●●●●●

Toallero barra 30 cm.
Towel bar small 30 cm.
Porte-serviette 30 cm.
Handtuchstange 30 cm.
Держатель для полотенца маленький 30 cm.

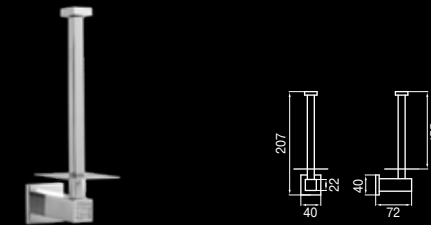

14 021 ●●●●●

Portarrollos reserva vertical
Roll holder reserve vertical
Support pour rouleau de réserve
Reserve papierrollerhalter
Вертикальный Бумагодержатель



14 005 ●●●●●

Percha
Wall hook
Porte-peignoir
Badenmantelhaken
Крючок на стену



14 004M ●●●●●

Toallero barra 40 cm.
Towel bar medium 40 cm.
Porte-serviette 40 cm.
Handtuchstange 40 cm.
Держатель для полотенца средний 40 cm.



14 004L ●●●●●

Toallero barra 60 cm.
Towel bar large 60 cm.
Porte-serviette 60 cm.
Handtuchstange 60 cm.
Держатель для полотенца большой 60 cm.



14 007 ●●●●●

Jabonera pared cristal
Soap dish holder
Porte-savon mural
Seifenschale zur wandmontage
Мыльница

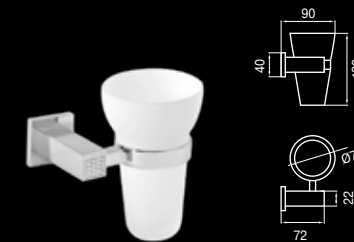

14 006 ●●●●●

Portavaso pared cristal
Tumbler holder
Porte-verre mural
Wandglashalter
Стакан держатель

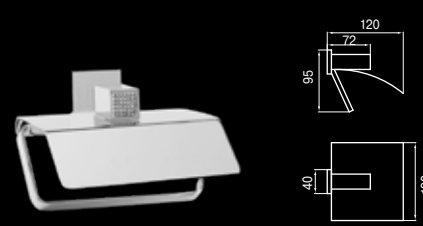

14 001 ●●●●●

Portarrollos con tapa
Roll holder with cover
Porte-papier avec couvercle
Wc-papierrollerhalter mit deckel
Бумагодержатель с крышкой



14 011 ●●●●●

Portarrollos
Roll holder
Porte-papier
Papierrollenhalter
Бумагодержатель

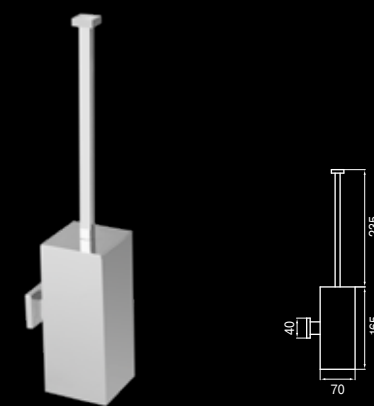

14 008 ●●●●●

Portaescobillas a pared
Wall mounted brush holder
Ensemble pot à balai mural
Wc-bürstentopf-garnitur
Ёршик настенный

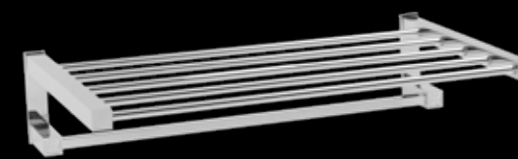

14 114 ●●●●●

Toallero estante 50 cm.
Towel holder stand 50 cm.
Porte-serviettes 50 cm.
Cadetuchhalter 50 cm.
Держатель для полотенец 50 cm.





KITCHEN

Kitchen



Una cocina smart. Un grifo de cocina debe lucir elegante, ser funcional y evocar sostenibilidad. El imán, la ducha extraíble y el filtro de bajo consumo de las colecciones de Maier garantizan todas estas virtudes y convierten la cocina en una estancia inteligente de diseño.

A smart sink mixer. A kitchen faucet should look elegant, be functional, and evoke sustainability. The magnet, the pull-out spray and the low-consumption filter of the Maier collections guarantee all these virtues and turn the kitchen into an intelligent design space.



CR
Cromo
Chrome
Chrom
Хром



NG
Negro mate
Matt black
Noir mate
Schwarz matte
Черное



NI
Níquel cepillado mate
Matt brushed nickel
Noir mate
Schwarz matte
Matt gebürstetes Nickel
Брашированный матовый никел



OC
Oro cepillado
Brushed gold
Or brossé
Gebürstetes gold
Брашированное золото



 Duchita extraíble
Pull-out Spray
Douchette extractible
Ausziehbrause
вытяжной душ



 Función spray
Spray Function
Fonction spray
Sprühfunktion
функция распыления



 Función chorro
Jet Function
Fonction jet
Jet-funktion
функция струи

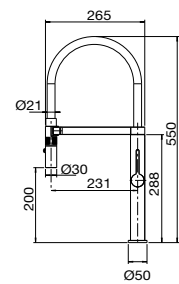

43 392 ●●●

Monomando cocina con imán para ducha extraíble de 2 funciones
 Sink Mixer magnet pull-out spray 2 jets
 Mitigeur évier aimant douchette extractible 2 fonctions
 Einhebel-Küchenmischer Magnet Ausziehbrause 2 jet
 Смеситель для кухни с вытяжным душем с магнитом. 2 виды струи

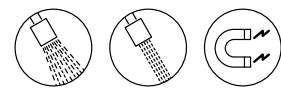

CR
Cromo
Chrome

NG
Negro mate
Matt black

OC
Oro cepillado
Brushed gold



43 392 OC



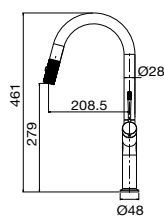

43 397 ●●●

Monomando cocina con ducha extraíble de 2 funciones
 Sink Mixer pull-out spray 2 jets
 Mitigeur évier douchette extractible 2 fonctions
 Einhebel-Küchenmischer Ausziehbrause 2 jet
 Смеситель для кухни с вытяжным душем. 2 виды струи



CR
Cromo
Chrome

NG
Negro mate
Matt black

OC
Oro cepillado
Brushed gold

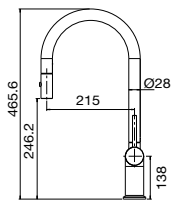

43 390 ●●●●

Monomando cocina con ducha extraíble de 2 funciones
 Sink Mixer pull-out spray 2 jets
 Mitigeur évier douchette extractible 2 fonctions
 Einhebel-Küchenmischer Ausziehbrause 2 jet
 Смеситель для кухни с вытяжным душем. 2 виды струи



CR
Cromo
Chrome

NG
Negro mate
Matt black

NI
Níquel cepillado mate
Matt brushed nickel

OC
Oro cepillado
Brushed gold



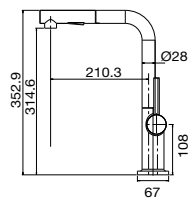

43 395 ●●●●

Monomando cocina con ducha extraíble de 2 funciones
 Sink Mixer pull-out spray 2 jets
 Mitigeur évier douchette extractible 2 fonctions
 Einhebel-Küchenmischer Ausziehbrause 2 jet
 Смеситель для кухни с вытяжным душем. 2 виды струи



CR
Cromo
Chrome

NG
Negro mate
Matt black

NI
Níquel cepillado mate
Matt brushed nickel

OC
Oro cepillado
Brushed gold



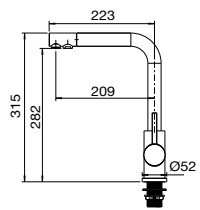

43 164 ●●
 Monomando cocina osmosis
 Sink mixer 3-way pure water
 Mitigeur évier fonction filtration de l'eau
 Einhebel-Küchenmischer Osmose 3 Wege
 Смеситель для кухни с осмосом

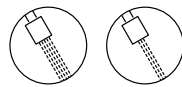

CR
 Cromo
 Chrome

NG
 Negro mate
 Matt black



43 164 NG

COMPLEMENTS



21 600-Univ ●●●●●●●●●●

Válvula click-clack 1 1/4 redonda con y sin rebosadero
Click-clack waste round
Vidage click-clack ronde
Click-clack ablauf 1 1/4 mit und ohne überlaufventil
клапан клик-клак 1 1/4 круглый, с и без слива



21 607 ●●●●●●●●●●

Sifón botella lavabo redondo latón
Basin trap round brass
Siphon ronde laiton
Siphon minimalistischen messing
Сифон круглый латунь



21 608 ●●●●●●●●●●

Sifón botella lavabo cuadrado latón
Basin trap square brass
Siphon carré laiton
Siphon quadrat messing
Сифон квадратный латунь



21 016 ●●●●●●●●●●

Llave de paso 1/2" -3/8" redonda
Angle valve 1/2" -3/8" round
Rubinet d' arrêt 1/2" -3/8" ronde
Eckventil 1/2" -3/8" rund
запорный вентиль 1/2" -3/8" круглый



21 017 ●●●●●●●●●●

Llave de paso 1/2" -1/2" redonda
Angle valve 1/2" -1/2" round
Rubinet d' arrêt 1/2" -1/2" ronde
Eckventil 1/2" -1/2" rund
запорный вентиль 1/2" -1/2" круглый



21 018 ●●●●●●●●●●

Llave de paso 1/2" -3/8" cuadrada
Angle valve 1/2" -3/8" square
Rubinet d' arrêt 1/2" -3/8" carré
Eckventil 1/2" -3/8" quadrat
запорный вентиль 1/2" -3/8" квадратный



21 019 ●●●●●●●●●●

Llave de paso 1/2" -1/2" cuadrada
Angle valve 1/2" -1/2" square
Rubinet d' arrêt 1/2" -1/2" carré
Eckventil 1/2" -1/2" quadrat
запорный вентиль 1/2" -1/2" квадратный

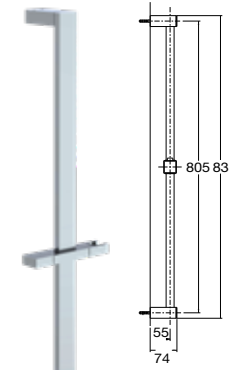
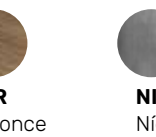

21 114 ●●●●●●●●●●

Barra deslizante de ducha cuadrada latón
Shower sliding bar square brass
Barre de douche glissant carrée laiton
Brausestange Quadrat messing
Душевая штанга квадратная из латуни



21 124 ●●●●●●●●●●

Kit barra deslizante de ducha cuadrada latón con flexo 1,70m y ducha de mano
Shower sliding bar square brass kit
Barre de douche glissant carrée laiton ensemble
Brausestange Quadrat messing set
Душевая штанга квадратная из латуни с шлангом 1,70 м и с ручным душем

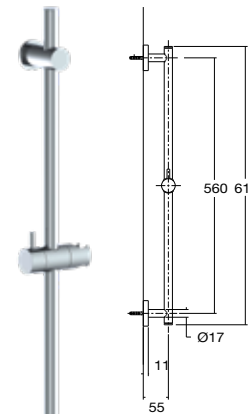

21 118 ●●●●●●●●●●

Barra deslizante de ducha redonda latón
Shower sliding bar round brass
Barre de douche glissant laiton ronde
Brausestange runden messing
Душевая штанга круглая из латуни



21 128 ●●●●●●●●●●

Kit barra deslizante de ducha redonda latón con flexo 1,70m y ducha de mano
Shower sliding bar round brass kit
Barre de douche glissant ronde laiton ensemble
Brausestange runden messing set
Душевая штанга круглая из латуни с шлангом 1,70 м и с ручным душем

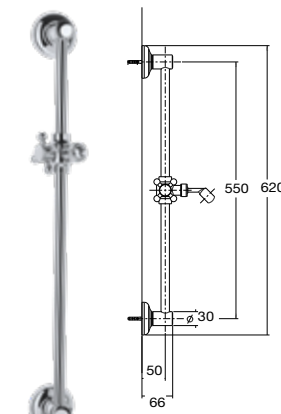

19 114 ●●●●●●●●●●

Barra deslizante de ducha "Memory"
Shower sliding bar "Memory"
Barre de douche glissant "Memory"
Brausestange "Memory"
душевая штанга "Мемори"



19 124 ●●●●●●●●●●

Kit barra deslizante de ducha "Memory"
Shower sliding bar kit "Memory"
Barre de douche glissant "Memory"
Brausegarnitur "Memory" brausestange
Душевой набор со штангой "Мемори"



21 136 ●●●●●●

Ducha hidromasaje 2 jets con pulsador D 120 mm
Hand shower hydromassage 2 sprays with push button D120 mm
Douchette hydromassage 2 jets D120 mm
Handbrause hydromassage 2 sprays D120 mm
Ручной душ гидромассаж 2 струй D120 mm



21 135 ●●●●

Ducha hidromasaje 3 jets D112 mm
Hand shower hydromassage 3 sprays D112 mm
Douchette hydromassage 3 jets D112 mm
Handbrause hydromassage 3 sprays D112 mm
Ручной душ гидромассаж 3 струй D112 mm



21 134 ●●●●●●●●

Ducha teléfono latón Kuadrat
Hand shower brass Kuadrat
Douchette Kuadrat laiton
Kuadrat handbrause messing
Ручная лейка-телефон из латуни Квадрат



21 133 ●●●●

Ducha teléfono ABS Kuadrat
Hand shower ABS Kuadrat
Douchette Kuadrat
Kuadrat handbrause
Ручная лейка-телефон ABS Квадрат



21 132 ●●●●●●

Ducha teléfono ABS Mini Star
Hand shower ABS Mini Star
Douchette Mini Star
Mini Star handbrause
Лейка-телефон АБС Мини Стар



21 139 ●●●●●●●●

Ducha teléfono Mini Star latón
Hand shower Mini Star brass
Douchette Mini Star laiton
Mini Star handbrause messing
Лейка-телефон Мини Стар латунь



21 131 ●●●●●●

Ducha teléfono Memory
Hand shower Memory
Douchette Memory
Memory handbrause
Ручная лейка- телефон Мемори



21 141 ●●●●●●

Ducha Teléfono Memory Latón
Hand Shower Memory Brass
Douchette Memory Laiton
Memory Handbrause Messing
Ручная лейка- телефон из латуни Мемори



21 101 ●●●●

Flexo 1,70 m latón
Flexible hose 1,70 m brass
Connexion flexible 1,7 m laiton
1,70 m flexiblen schlauch
душевой шланг 1,70 m латунь



21 097 ●●●●●●●●

Flexo 1,70 m PVC
Flexible hose 1,70 m PVC
Connexion flexible 1,70 m PVC
1,70 m flexiblen PVC
душевой шланг 1,70 m PVC



21 096 ●●●●●●●●

Flexo 1,20 m PVC
Flexible hose 1,20 m PVC
Connexion flexible 1,20 m PVC
1,20 m flexiblen PVC
душевой шланг 1,20 m PVC

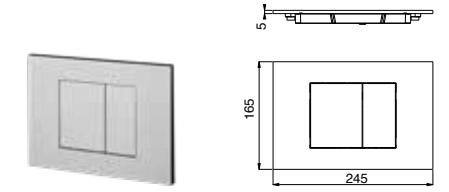

21 650 ●●●●●●●●

Placa pulsador wc
Flush plate wc
Plaque de déclenchement wc
Betätigungsplatte für wc
Клавиша смыва

Compatible con/with: GEBERIT & TECE



21 105 ●●●●●●

Soporte rotula bayoneta
Hand shower wall support
Support douche
Brausehalter
Держатель для душевой лейки ориентируемый



21 112 ●●●●●●

Soporte ABS Mini Star
Hand shower wall support Mini Star
Support douche Mini Star
Mini Star abs brausehalter
Держатель для душевой лейки АБС Мини Стар



21 123 ●●●●●●●●

Soporte de latón
Hand shower brass wall support
Support douche laiton
Brausehalter messing
Держатель для душевой лейки латунь



21 113 ●●●●●●

Soporte ABS Surf, Kuadrat
Hand shower wall support Surf, Kuadrat
Surf, Kuadrat support douche
Surf, Kuadrat abs brausehalter
Держатель для душевой лейки латунь АБС Сульф. Квадрат

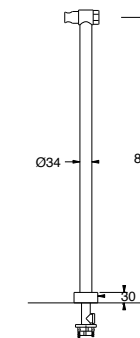

21 512 ●●●●●●

Columnas para bañera de instalación a pavimento 820 mm
Columns for floor standing bath 820 mm
Colonnes pour baignoire non-percé installation au sol 820 mm
Spalten für freistehende Badewanne 820 mm
Колонны для автономной ванны 820 mm



CR
Cromo
Chrome



BL
Blanco mate
Matt white



NG
Negro mate
Matt black



CO
Cobre mate
Matt copper



BR
Bronce antiguo mate
Old matt bronze



NI
Níquel cepillado mate
Matt brushed nickel



O
Oro
Gold



OR
Oro Rosa
Rose Gold



OC
Oro cepillado
Brushed gold



42 041

Cartucho cerámico D25 mm salida libre
Series: 43,48,42,46,47,49 (002/102/702)
Ceramic disk cartridge D25 mm
Cartouche céramique D25 mm
Unterputz kartusche D25 mm
Керамический картридж д 25 mm



48 041

Cartucho cerámico D25 mm salida dirigida
Series: 66,67,68,69 (002/102) - 43,48,74 (012/015) - 42/46 (302)
Ceramic disk cartridge D25 mm
Cartouche céramique D25 mm
Unterputz kartusche D25 mm
Керамический картридж д 25 mm



40 041

Montura cerámica R1/2" - 1/4 vuelta
Series: 19,71,72,73,75,77,78,79,81,82,76
Ceramic head valve
Tête céramique
Ventileinsatz keramisch dichtend
Сменный керамический клапан



71 041

Montura cerámica R1/2" - 1/4 vuelta.
Series: 71,72,73 (016,320,330,340)
Ceramic head valve
Tête céramique
Ventileinsatz keramisch dichtend
Сменный керамический клапан



74 041

Cartucho cerámico D25 mm salida libre
Series: 74
Ceramic disk cartridge D25 mm
Cartouche céramique D25 mm
Unterputz kartusche D25 mm
Керамический картридж д 25 mm



44 041

Cartucho cerámico D35 mm salida dirigida
Series: 43,48 (302/312/315)
Ceramic disk cartridge D35 mm
Cartouche céramique D35 mm
Unterputz kartusche D35 mm
Керамический картридж д 35 mm



21 129 ●●

Distribuidor baño-ducha
Bath shower diverter
Inverseur bain-douche
Bad und dusch umschalter
Переключатель ванна-душ



21 119 ●●

Distribuidor baño-ducha "Planet"
Bath shower diverter "Planet"
Inverseur bain-douche "Planet"
Bad und dusch umschalter "Planet"
Переключатель ванна-душ "Планет"



52 041

Cartucho cerámico D35 mm salida libre
Series: 58,59,61
Ceramic disk cartridge D35 mm
Cartouche céramique D35 mm
Aufputz Kartusche D35 mm
Керамический картридж Д35 mm.



28 041

Cartucho cerámico D 40mm salida dirigida
Series: fregaderas / kitchen
Ceramic disk cartridge D40 mm
Cartouche céramique D40 mm
Unterputz kartusche D40 mm
Керамический картридж д 40 mm



58 041

Cartucho cerámico D40 mm salida dirigida
Series: 58,59,74 (302/312/315)
Ceramic disk cartridge D40 mm
Cartouche céramique D40 mm
Unterputz kartusche D40 mm
Керамический картридж д 40 mm

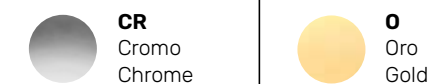



DISPLAYS



21590

Expositor mesa 110 x 60 x 75 cm
 Table display 110 x 60 x 75 cm
 Presentoir table 110 x 60 x 75 cm
 Tisch display 110 x 60 x 75 cm
 Выставочный стол 110 x 60 x 75 cm



21590

Expositor mesa 110 x 60 x 75 cm
 Table display 110 x 60 x 75 cm
 Presentoir table 110 x 60 x 75 cm
 Tisch display 110 x 60 x 75 cm
 Выставочный стол 110 x 60 x 75 cm

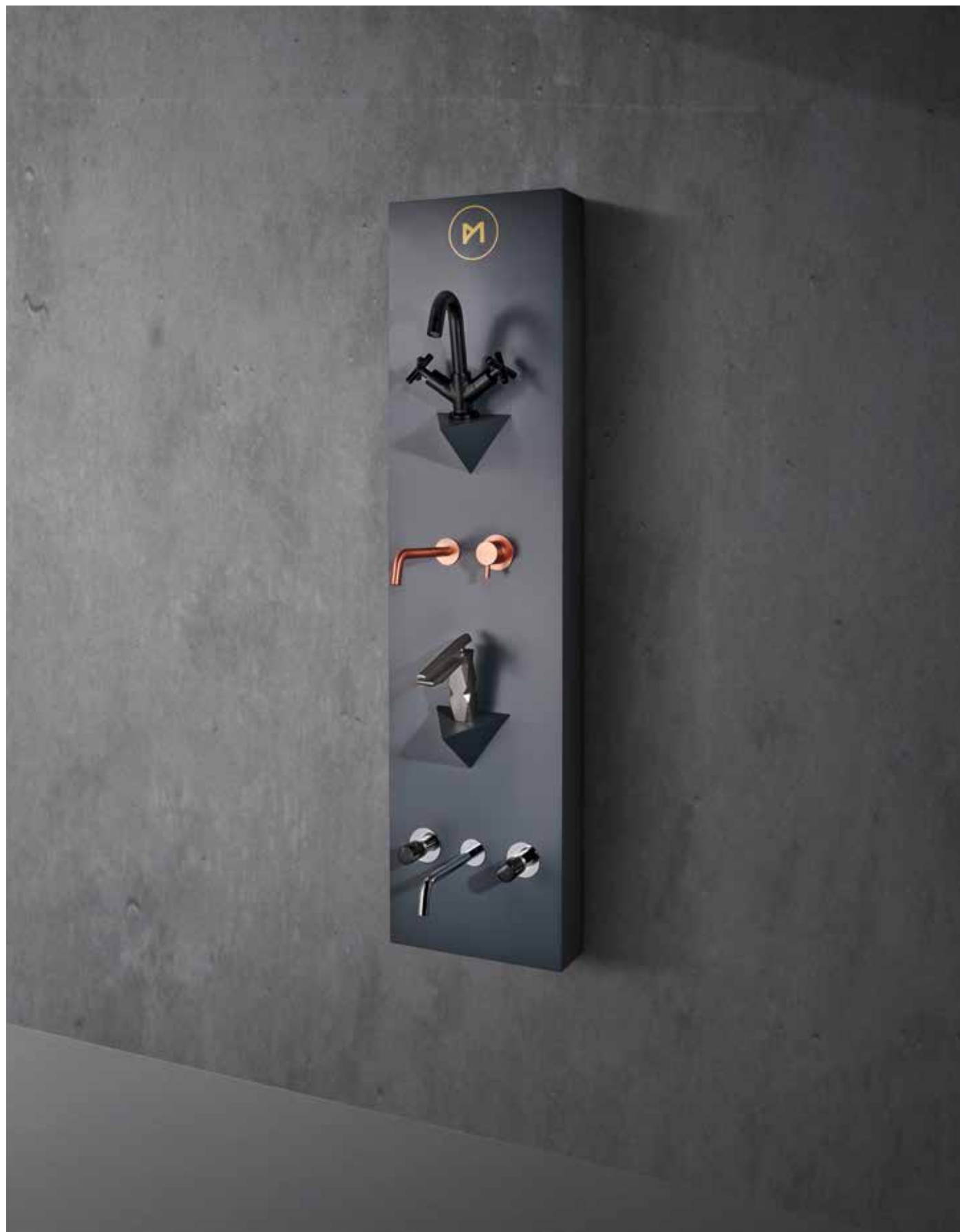

21530

Expositor paret 140 x 35 x 10 cm
 Wall display 140 x 35 x 10 cm
 Presentoir mur 140 x 35 x 10 cm
 Wand display 140 x 35 x 10 cm
 Выставочный стена 140 x 35 x 10 cm

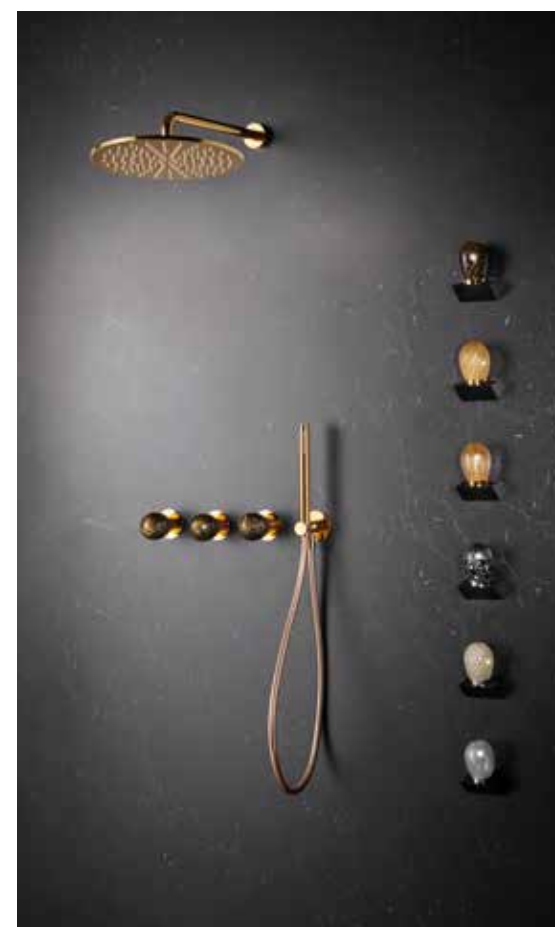



21 152

Base peana doble expositor
Acrylic base display double
Presentoir acrylique piédestal double
Acrylglassockel display doppelt
Акриловая подставка двойная

21 150

Base peana individual expositor
Acrylic base display single
Presentoir acrylique piédestal individuel
Acrylglassockel display
Акриловая подставка

CONDICIONES GENERALES

1. PRECIOS

Los precios de la lista de precios o de cualquier anexo que publiquemos, deben ser considerados precios recomendados de venta al público (P.V.P.) antes de impuestos. Los precios están sujetos a cualquier modificación debido a las circunstancias del mercado, materias primas, mano de obra, impuestos, etc. Griferías Maier, S.L. (Maier) comunicará a sus clientes cualquier cambio que se produzca a través de las vías de comunicación habituales (representantes, email, fax, etc.). La lista de precios anula y sustituye todas las precedentes.

2. PEDIDOS Y ACEPTACIÓN CONDICIONES

Con la realización de un pedido, el cliente acepta tácitamente todas las condiciones abajo expuestas. El pedido está sujeto a la aceptación o anulación por parte de Maier.

3. PLAZO DE ENTREGA

El plazo de entrega es siempre aproximado y Maier no se hace responsable de las consecuencias debidas a cualquier retraso.

4. DISEÑO

Nuestros productos podrán ser modificados por exigencias de diseño, sin previo aviso, siempre para mejorar con ello el producto final. El material gráfico y/o el diseño impreso en los catálogos, tarifas, folletos y demás soportes publicitarios tienen valor indicativo, por lo que el cliente no podrá acogerse a ellos en caso de posibles quejas por disconformidad o diferencia con los productos suministrados. Las reclamaciones al respecto deberán realizarse, como máximo, en los quince (15) días naturales siguientes a la entrega de la mercancía en destino.

5. EXPEDICIONES

Incluso a portes pagados, la mercancía siempre viaja por cuenta y riesgo del comprador. El destinatario, comprobará, al recibo de la mercancía, el estado de la misma, indicando en el albarán del transportista las posibles incidencias.

6. DEVOLUCIONES

Maier no admitirá devoluciones de material que anteriormente no se hayan acordado y autorizado por nuestro Representante o Dirección. Los envíos de mercaderías a devolver deberán efectuarse a portes pagados por el cliente. Maier no aceptará ninguna devolución de mercancía fuera de las coberturas y plazos de nuestra garantía. En caso de recibir la mercancía perfectamente encajada, esta sufrirá una depreciación del 10% si es del año en curso y del 40% si es anterior a 3 años.

7. GARANTÍA

Nuestra grifería está garantizada por 5 años contra todo defecto de fabricación en sus componentes a excepción del acabado superficial diferente al Cromo, que es de 2 años. Todos estos periodos contados desde la fecha de compra. Cualquier anomalía producida por mal uso, manipulaciones, instalaciones incorrectas, implantaciones de recambios no originales así como la acción producida por elementos extraños conducidos por el agua, dejará sin efecto esta garantía. La garantía no incluye los portes ni los posibles costes de la mano de obra en la sustitución de piezas ni la reparación de daños que ocasionalmente pudieran producirse.

Para cualquier reclamación, adjuntar la tarjeta de garantía que viene en la caja del producto y una copia de la factura con la fecha de compra.

8. RESERVA DE DOMINIO

Maier será propietario de todos los productos suministrados al cliente hasta el cobro completo de la factura correspondiente.

9. JURISDICCIÓN

La buena fe que impera en las relaciones de Maier con sus clientes y nuestro deseo de resolver cualquier diferencia por vía amistosa, no hacen pensar en cualquier reclamación judicial. Sin embargo, en la improbable situación que se dé el caso, ambas partes deberán someterse única y exclusivamente a los tribunales de Barcelona (España).

SALES CONDITIONS

1. PRICES

The prices of the Price-List or any annex that we shall publish, should be considered as "Suggested Retail Prices before taxes". The prices are subject to variation due to market circumstances, raw material, labour, taxes, etc. without previous advice. Griferías Maier, S.L. (Maier) will inform the customers of any change through the usual communication channels (agents, email, fax, etc.). The price list cancels and replaces all its precedent.

2. ORDERS AND CONDITIONS ACCEPTANCE

With the remittance of an order, the client tacitly accepts all the conditions below. The order is subject to acceptance or cancellation by Maier.

3. DELIVERY TIME

The delivery is always approximate and Maier is not responsible for the consequences of any delay.

4. DESIGN

Our products can be modified without notice by design requirements, provided to thereby improve the final product. Graphic material and/or the printed design on the catalogs, price lists, brochures and other advertising media are indicative only, so customers can not take them as reference in case of possible complaints by disagreement or difference with the products supplied. Any claim regarding a disconformity with the products supplied must be made in a maximum of fifteen (15) calendar days following the delivery of the goods at destination.

5. SHIPMENTS

Even prepaid, the goods always travel at the risk of the buyer. The recipient shall verify the receipt of goods, the state of the same, indicating in the delivery note any incidents.

6. RETURNS

Maier will not accept returns of materials not previously agreed and authorized by our Representative or our Management. Return shipment of merchandise shall be paid by the customer. Maier will not accept any return of merchandise out of the coverage and terms of our guarantee. In case we receive the goods in its box and in perfect condition, this will suffer a depreciation of 10% if returned within the current year and of 40% if it is before than 3 years following the delivery of the goods at destination.

7. GUARANTEE

Maier faucets are guaranteed for 5 years against any manufacturing defects in its components with the exception of different surface finishes than Chrome, which is for 2 years. All these periods are counted from the date of purchase. Any failure caused by misuse, tampering, improper installation, deployment of non-original spare parts and the action produced by strange elements driven by water, will void this warranty. The warranty does not include freight or any labor costs in the replacement of parts neither any related damage repair that may occur occasionally. For any claim, it is necessary to enclose the warranty card that comes in the product box and a copy of the invoice showing the purchase date.

8. RETENTION OF PROPERTY

Maier will own all goods delivered to the customer until full payment of the invoice.

9. JURISDICTION

The good faith prevailing in Maier relations with customers and our desire to resolve any differences amicably, makes any judicial claim improbable. However, in the unlikely event that this case is given, both parties shall be submitted exclusively to the courts of Barcelona (Spain).

